

### DESCRIPTION

The EV8865-Q-00A is used for demonstrating the performance of MPS's MP8865. MP8865 is a highly integrated and high frequency synchronous step-down switcher with I<sup>2</sup>C control interface. It is optimized to support up to 6A load current over an input supply range from 4.5V to 21V with excellent load and line regulation.

Current-Mode operation provides fast transient response and eases loop stabilization. The output voltage level can be controlled, on-the fly through a 3.4Mbps I<sup>2</sup>C serial interface. Voltage range can be adjusted from 0.6V to 1.87V in 10mV steps. Voltage slew rate, switching frequency and power savings mode are also selectable through the I<sup>2</sup>C interface. Fully protection features includes over current protection, over voltage protection and over temperature protection.

MP8865 is available in QFN15 (3mmx3mm) package.

### ELECTRICAL SPECIFICATION

Parameter	Symbol	Value	Units
Input Voltage	V <sub>IN</sub>	4.5– 21	V
Output Voltage	V <sub>OUT</sub>	1.2	V
Output Current	I <sub>OUT</sub>	6	A

### FEATURES

- Wide 4.5V-to-21V Operation Input Range
- 45mΩ/18mΩ Low R<sub>DS(ON)</sub> Internal Power MOSFETs
- 1% V<sub>OUT</sub> Accuracy
- I<sup>2</sup>C Programmable Output Range from 0.6V to 1.87V in 10mV Steps with Slew Rate Control
- I<sup>2</sup>C Selectable Switching Frequency. Default 600kHz Switching Frequency.
- Programmable Default Output Voltage
- Power Saving Mode, OTP and OCP Via I<sup>2</sup>C
- Power Good Indication
- 1 bit I<sup>2</sup>C Address Set pin
- OCP Protection and Hiccup
- External Soft Start
- Available in QFN3x3 Package

### APPLICATIONS

- Flat-Panel Television and Monitors
- Digital Set-Top Boxes
- Distributed Power Systems

All MPS parts are lead-free, halogen free, and adhere to the RoHS directive. For MPS green status, please visit MPS website under Quality Assurance.

"MPS" and "The Future of Analog IC Technology" are Registered Trademarks of Monolithic Power Systems, Inc.

### EV8865-Q-00A EVALUATION BOARD



Board Number	MPS IC Number
EV8865-Q-00A	MP8865GQ

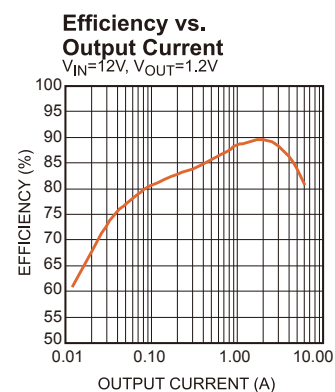

## EVALUATION BOARD SCHEMATIC

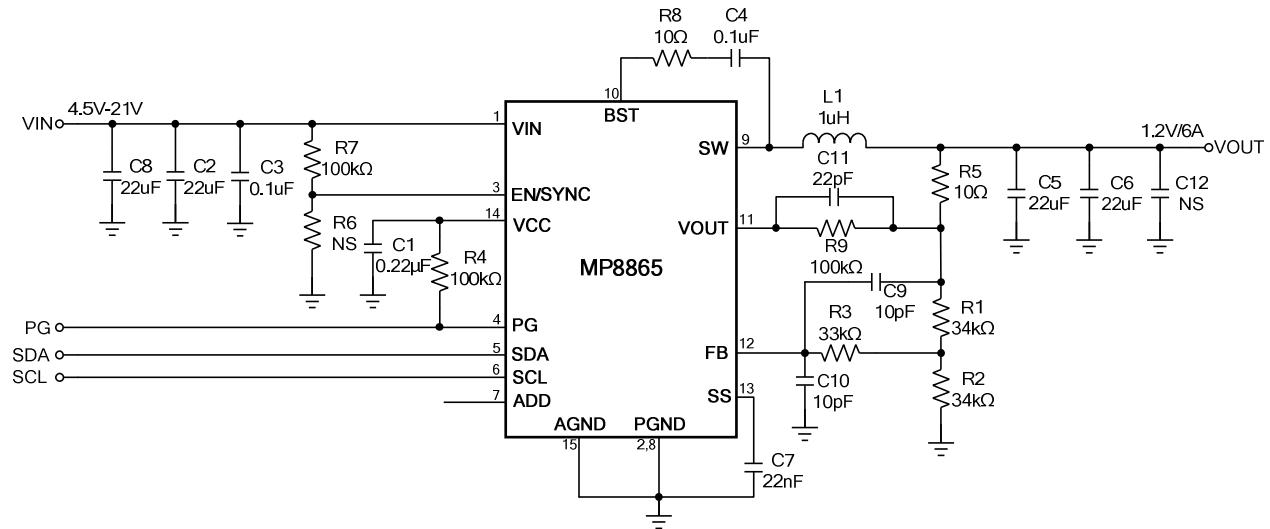

## EV8865-Q-00A BILL OF MATERIALS

Qty	RefDes	Value	Description	Package	Manufacturer	Manufacturer P/N
1	C1	0.22 $\mu$ F	Ceramic Cap., 16V, X7R	0603	muRata	GRM188R71C224KA01D
2	C2,C8	22 $\mu$ F	Ceramic Cap., 25V, X5R	1206	muRata	GRM31CR61E226KE15L
2	C3,C4	0.1 $\mu$ F	Ceramic Cap., 25V, X7R	0603	muRata	GRM188R71C104KA01D
2	C5,C6	22 $\mu$ F	Ceramic Cap., 10V, X7R	1206	muRata	GRM31CR70A226KE19L
1	C7	22nF	Ceramic Cap., 50V, X7R	0603	muRata	GRM188R71H223KA01D
2	C9,C10	10pF	Ceramic Cap., 50V, C0G	0603	muRata	GRM1885C1H100JA01D
1	C11	22pF	Ceramic Cap., 50V, C0G	0603	muRata	GRM1885C1H220JA01D
0	C12	NS				
1	R1	34k	Thick Film Res., 1%	0603	Yageo	9C06031A3402FKHFT
1	R2	34k	Thick Film Res., 1%	0603	Yageo	9C06031A3402FKHFT
1	R3	33k	Thick Film Res., 1%	0603	Yageo	9C06031A3302FKHFT
3	R4,R7,R9	100k	Thick Film Res., 1%	0603	Yageo	9C06031A1003FKHFT
1	R5,R8	10 $\Omega$	Thick Film Res., 5%	0603	Yageo	9C06031A10R0JLHFT
0	R6	NS				
1	L1	1 $\mu$ H	Inductor, DCR=4.6m $\Omega$ , Is=19A	6.9 $\times$ 6.9 $\times$ 3.8mm	Wurth	744311100
1	U1	MP8865GQ	Synchronous Step-Down Convert	QFN3*3	MPS	MP8865GQ

## EVB TEST RESULTS

Performance waveforms are tested on the evaluation board.

$V_{IN} = 12V$ ,  $V_{OUT} = 1.2V$ ,  $L = 1\mu H$ ,  $T_A = 25^\circ C$ , unless otherwise noted.

**Efficiency vs. Output Current**  
 $V_{IN}=12V$ ,  $V_{OUT}=1.2V$

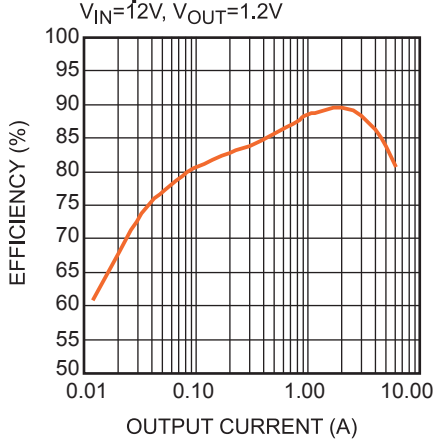

**Case Temperature Rise vs.  $I_{OUT}$**   
 $V_{OUT}=1.2V$

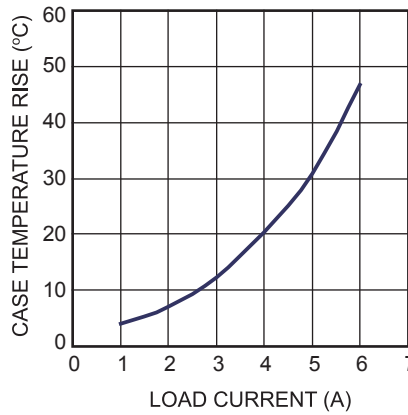

**Load Regulation**

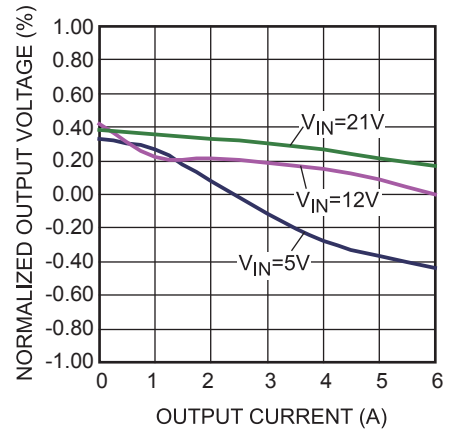

**Line Regulation**  
 $V_{IN}=5V-21V$

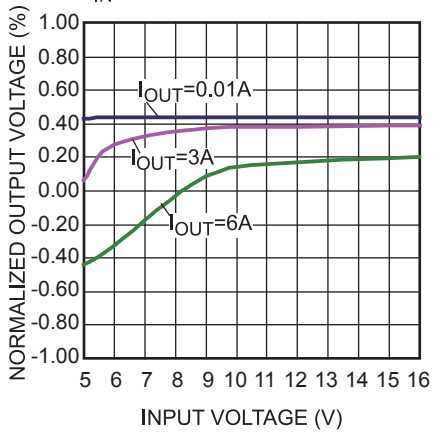

## EVB TEST RESULTS *(continued)*

Performance waveforms are tested on the evaluation board.

$V_{IN} = 12V$ ,  $V_{OUT} = 1.2V$ ,  $L = 1\mu H$ ,  $T_A = 25^\circ C$ , unless otherwise noted.

**Short Entry**

$I_{OUT} = 0A$

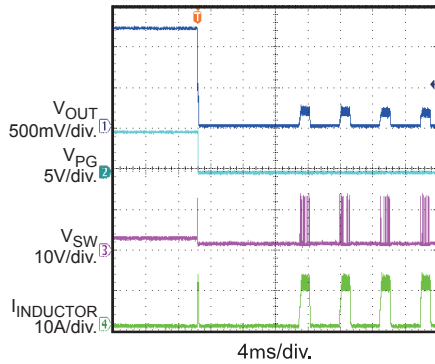

**Short Recovery**

$I_{OUT} = 0A$

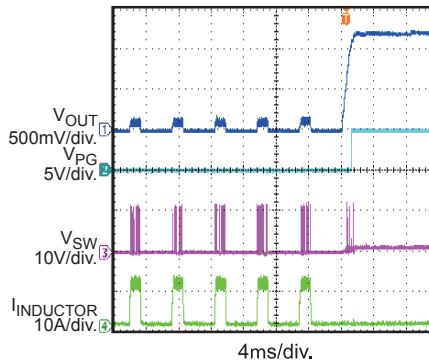

**Startup through Enable**

$I_{OUT} = 0A$

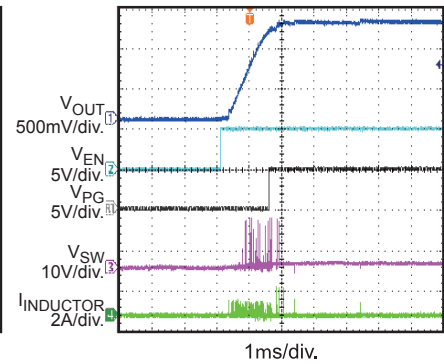

**Startup through Enable**

$I_{OUT} = 6A$

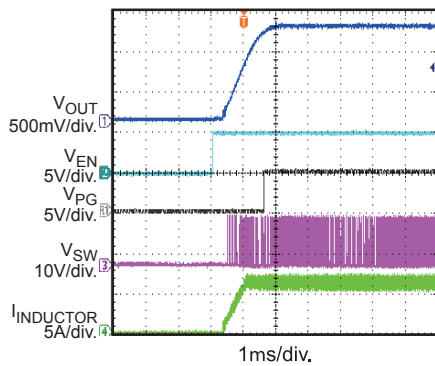

**Shutdown through Enable**

$I_{OUT} = 0A$

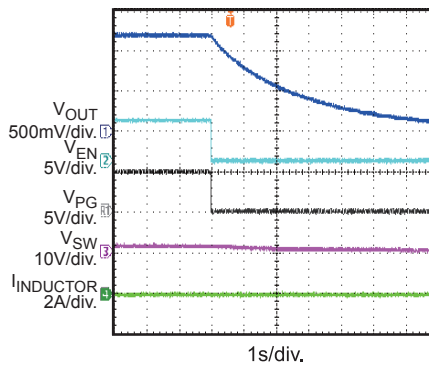

**Shutdown through Enable**

$I_{OUT} = 6A$

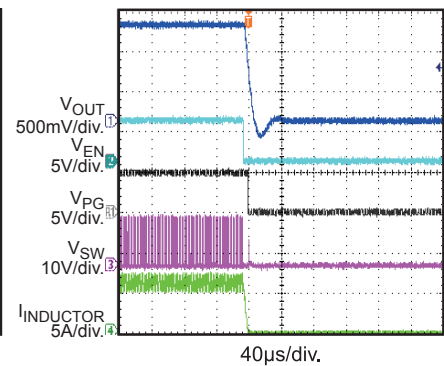

**Startup through Input Voltage**

$I_{OUT} = 0A$

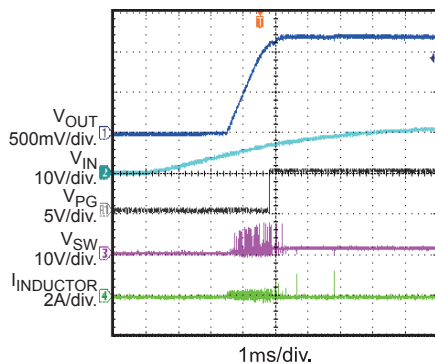

**Startup through Input Voltage**

$I_{OUT} = 6A$

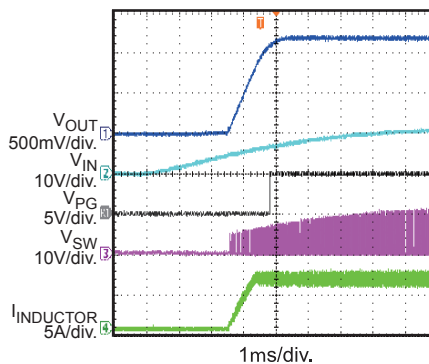

**Shutdown through Input Voltage**

$I_{OUT} = 0A$

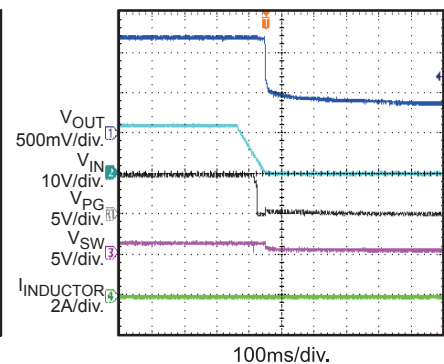

**EVB TEST RESULTS (continued)**

Performance waveforms are tested on the evaluation board.

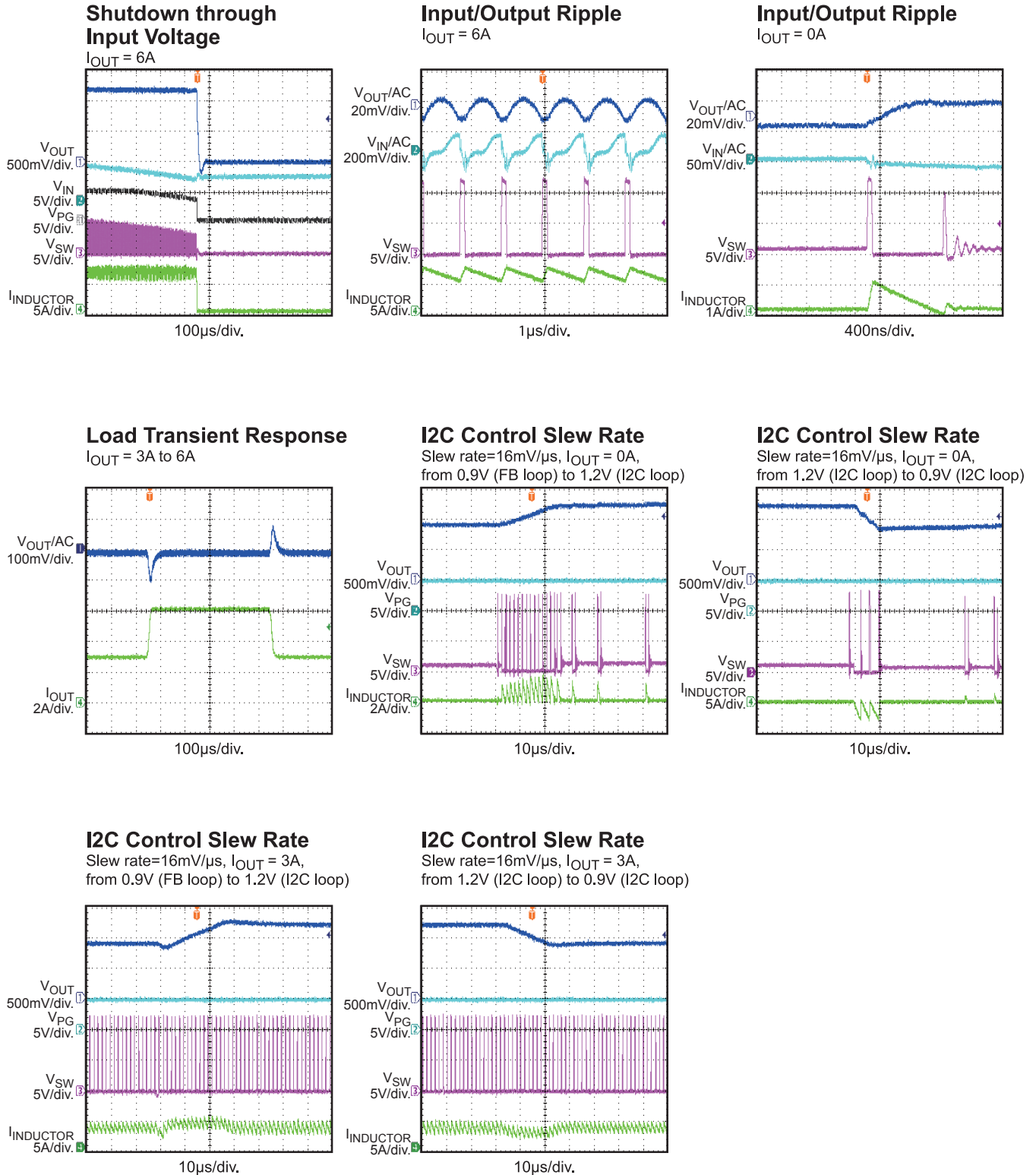
 $V_{IN} = 12V$ ,  $V_{OUT} = 1.2V$ ,  $L = 1\mu H$ ,  $T_A = 25^\circ C$ , unless otherwise noted.

## PRINTED CIRCUIT BOARD LAYER

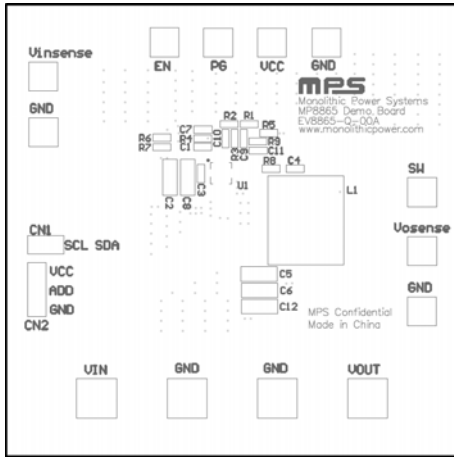

Figure 1: Top Silk Layer

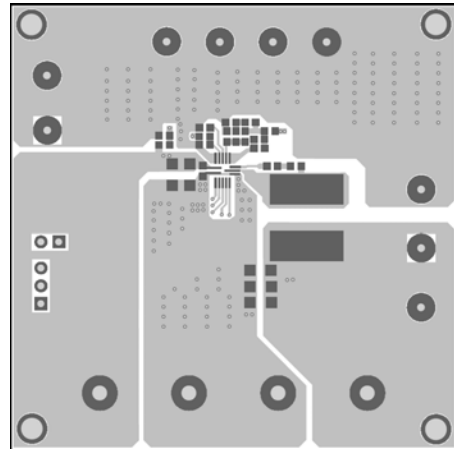

Figure 2: Top Layer

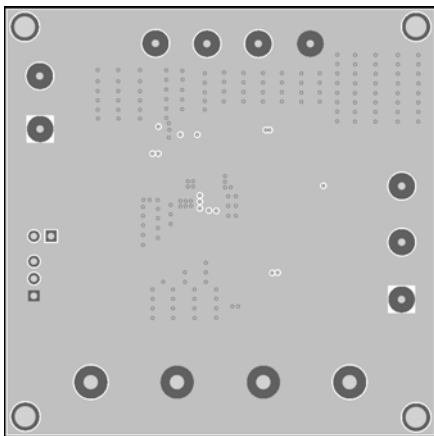

Figure 3: Inner 1 Layer

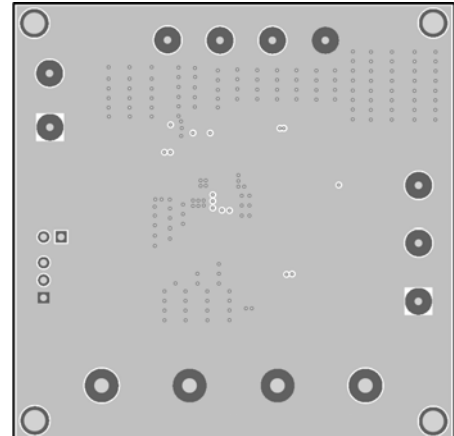

Figure 4: Inner 2 Layer

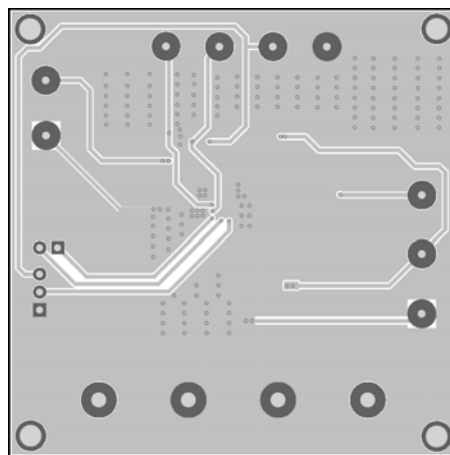

Figure 5: Bottom Layer

## QUICK START GUIDE

1. Connect the positive and negative terminals of the load to the VOUT and GND pins, respectively.
2. Preset the power supply output between 4.5V and 21V, and then turn off the power supply.
3. Connect the positive and negative terminals of the power supply output to the VIN and GND pins, respectively.
4. Turn the power supply on. The board will automatically start up.
5. To use the Enable function, apply a digital input to the EN pin. Drive EN higher than 1.4V to turn on the regulator, or less than 1.25V to turn it off.

**NOTICE:** The information in this document is subject to change without notice. Please contact MPS for current specifications. Users should warrant and guarantee that third party Intellectual Property rights are not infringed upon when integrating MPS products into any application. MPS will not assume any legal responsibility for any said applications.