

### DESCRIPTION

The EV8716EN-00A is an evaluation board for the MP8716, a high frequency step-down regulator with an integrated power MOSFET.

The MP8716 is a high frequency synchronous rectified step-down switch mode converter with built in internal power MOSFETs. It offers a very compact solution to achieve 3A continuous output current over a wide input supply range with excellent load and line regulation. The MP8716 has synchronous mode operation for higher efficiency over output current load range.

Current mode operation provides fast transient response and eases loop stabilization.

Full protection features include OCP and thermal shut down.

The MP8716 requires a minimum number of readily available standard external components and is available in a space saving 8-pin SOIC package with an exposed pad.

### ELECTRICAL SPECIFICATIONS

Parameter	Symbol	Value	Units
Input Voltage	$V_{IN}$	8 – 21	V
Output Voltage	$V_{OUT}$	1.2	V
Output Current	$I_{OUT}$	0 – 3	A

### FEATURES

- Wide 8V to 21V Operating Input Range
- 3A Output Current
- Fixed 500KHz Switching Frequency
- Sync from 300KHz to 2MHz External Clock
- OCP Protection and Thermal Shutdown

### APPLICATIONS

- Notebook Systems and I/O Power
- Networking Systems
- Digital Set Top Boxes
- Personal Video Recorders
- Flat Panel Television and Monitors
- Distributed Power Systems

"MPS" and "The Future of Analog IC Technology" are Registered Trademarks of Monolithic Power Systems, Inc.

### EV8716EN-00A EVALUATION BOARD



Board Number	MPS IC Number
EV8716EN-00A	MP8716EN

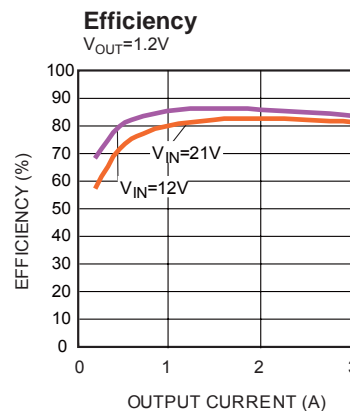

## EVALUATION BOARD SCHEMATIC

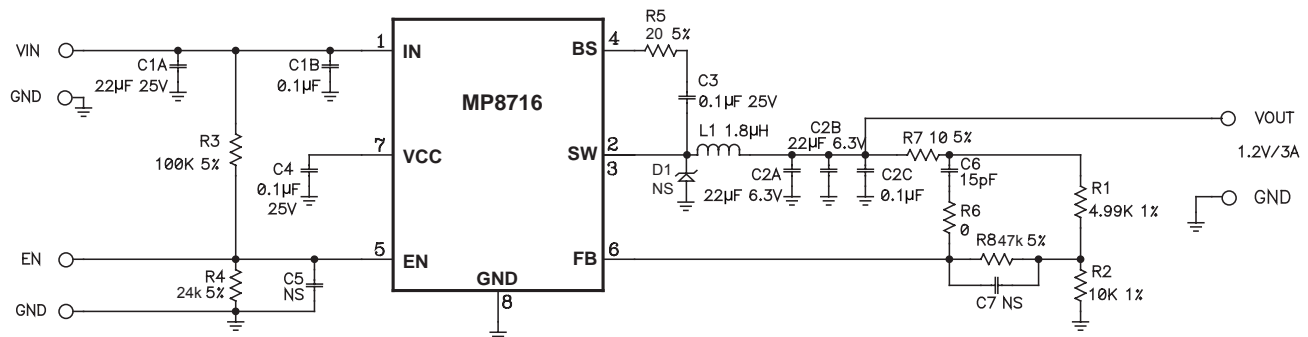

## EV8716EN-00A BILL OF MATERIALS

Qty	Ref	Value	Description	Package	Manufacturer	Part Number
1	C1A	22µF	Ceramic Cap., 25V, X5R	1210	Murata	GRM32ER61E226KE15L
1	C1B	0.1µF	Ceramic Cap., 25V, X7R	0805	TDK	C2012X7R1E104K
2	C2A,C2B	22µF	Ceramic Cap., 6.3V, X5R	1210	TDK	C3225X5R0J226M
1	C2C	0.1µF	Ceramic Cap., 16V, X7R	0805	Murata	GRM219R71C104KA01D
2	C3,C4	0.1µF	Ceramic Cap., 25V, X7R	0603	TDK	C1608X7R1E104K
0	C5	NS				
1	C6	15pF	Ceramic Cap., 50V, C0G	0603	TDK	C1608C0G1H150J
0	C7	NS				
1	R1	4.99kΩ	Film Res., 1%	0603	Yageo	RC0603FR-074K99L
1	R2	10kΩ	Film Res., 1%	0603	Yageo	RC0603FR-0710KL
1	R3	100kΩ	Film Res., 5%	0603	Any	
1	R4	24kΩ	Film Res., 5%	0603	Any	
1	R5	20Ω	Film Res., 5%	0603	Any	
1	R6	0Ω	Film Res., 5%	0603	Any	
1	R7	10Ω	Film Res., 5%	0603	Any	
1	R8	47kΩ	Film Res., 5%	0603	Any	
1	L1	1.8µH	7.6mΩ, DCR, 10.4A	SMD	TOKO	D104C-919AS-1R8N
		1.5µH	10mΩ,DCR,14A	SMD	Würth	744311150
0	D1	NS				
1	U1		Step-Down Converter	SOIC8E	MPS	MP8716EN

## PRINTED CIRCUIT BOARD LAYOUT

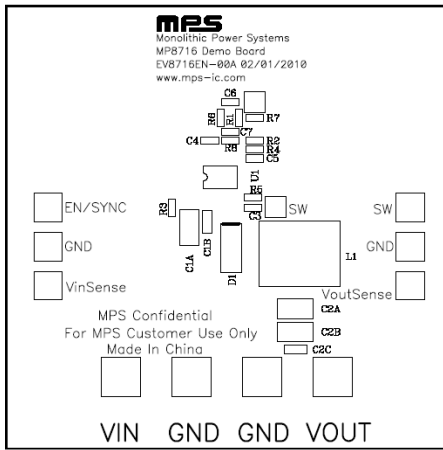

Figure 1—Top Silk Layer

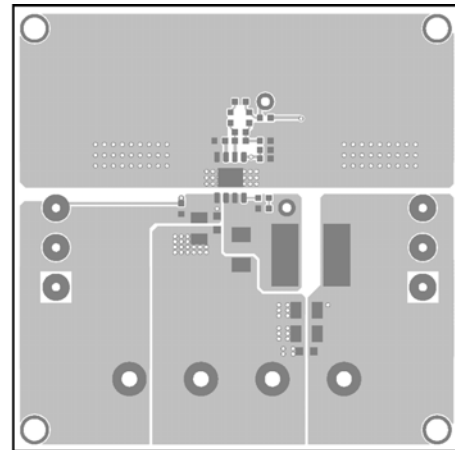

Figure 2—Top Layer

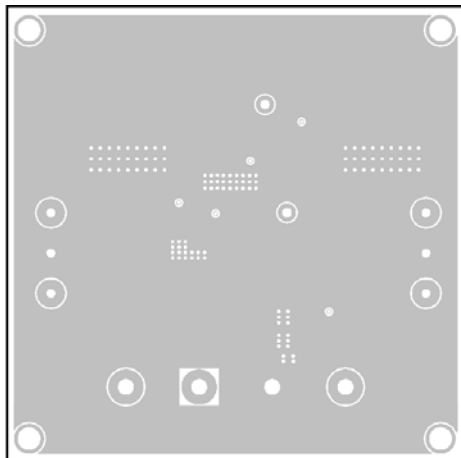

Figure 3—Inner Layer 1

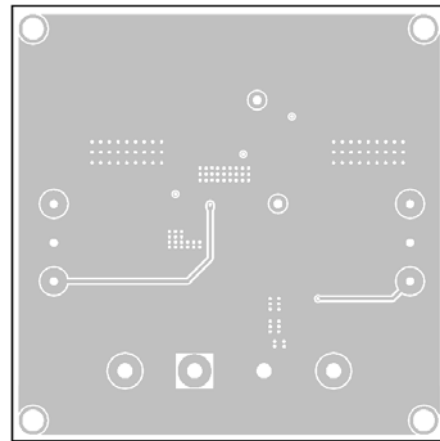

Figure 4—Inner Layer 2

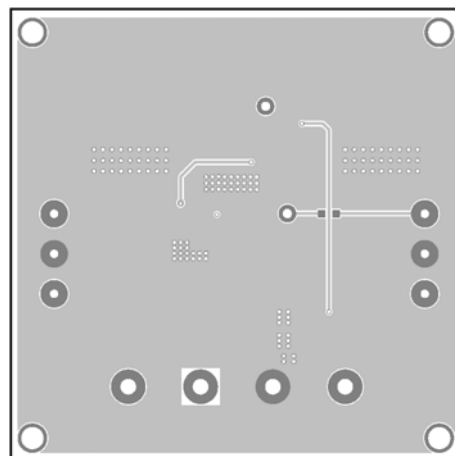

Figure 5—Bottom Layer

## QUICK START GUIDE

1. Connect the positive and negative terminals of the load to the VOUT and GND pins, respectively.
2. Preset the power supply output between 8V and 21V, then turn off the power supply.
3. Connect the positive and negative terminals of the power supply output to the VIN and GND pins, respectively.
4. Turn the power supply on. The board will automatically startup.
5. To use the Enable function, apply a digital input to the EN pin. Drive EN higher than 2V to turn on the regulator or less than 0.4V to turn it off.
6. Apply up to 2MHz frequency logic level clock signal to the EN pin to synchronize the device to an external clock. The duty cycle is not critical.

**NOTICE:** The information in this document is subject to change without notice. Users should warrant and guarantee that third party Intellectual Property rights are not infringed upon when integrating MPS products into any application. MPS will not assume any legal responsibility for any said applications.