



EV6540-U-00A

5.5V to 35V, Three-Phase Brushless DC Motor Driver Evaluation Board

DESCRIPTION

The EV6540-U-00A is an evaluation board for the MP6540, a three-phase BLDC motor driver.

It operates from a supply voltage of up to 35V. It integrates 3 half bridges consisting of 6 N-channel Power MOSFETs. The rotor position information is provided by the Hall sensors assembled in the motor and the driving control signals are generated by the external controller, such as MCU, FPGA, etc.

ELECTRICAL SPECIFICATIONS

Parameter	Symbol	Value	Units
Input Voltage	VIN	5.5 - 35	V
VREF Voltage	VREF	3.3 or 5	V

FEATURES

- Wide 5.5V to 35V Input Voltage Range
- Low On-Resistance
- Integrated Bi-directional Current Sense Amplifiers
- Support 100% Duty Cycle Operation
- EN/PWM Logic Input
- OCP, OTP
- Fault Indication Output

APPLICATIONS

- 3-Phase Brushless DC Motors and Permanent Magnet Synchronous Motors
- Power Drills
- Impact Drivers

All MPS parts are lead-free, halogen-free, and adhere to the RoHS directive. For MPS green status, please visit the MPS website under Quality Assurance. "MPS" and "The Future of Analog IC Technology" are registered trademarks of Monolithic Power Systems, Inc.

EV6540-U-00A EVALUATION BOARD



(L x W x H) 2" x 2" x 0.4"
(5cm x 5cm x 1cm)

Board Number	MPS IC Number
EV6540-U-00A	MP6540GU

EVALUATION BOARD SCHEMATIC

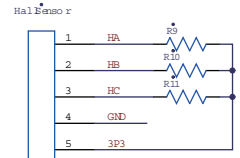
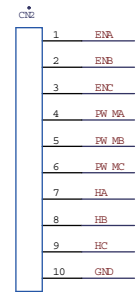
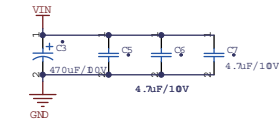
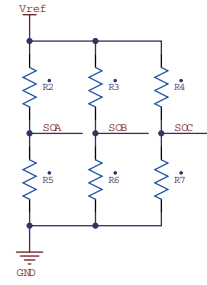
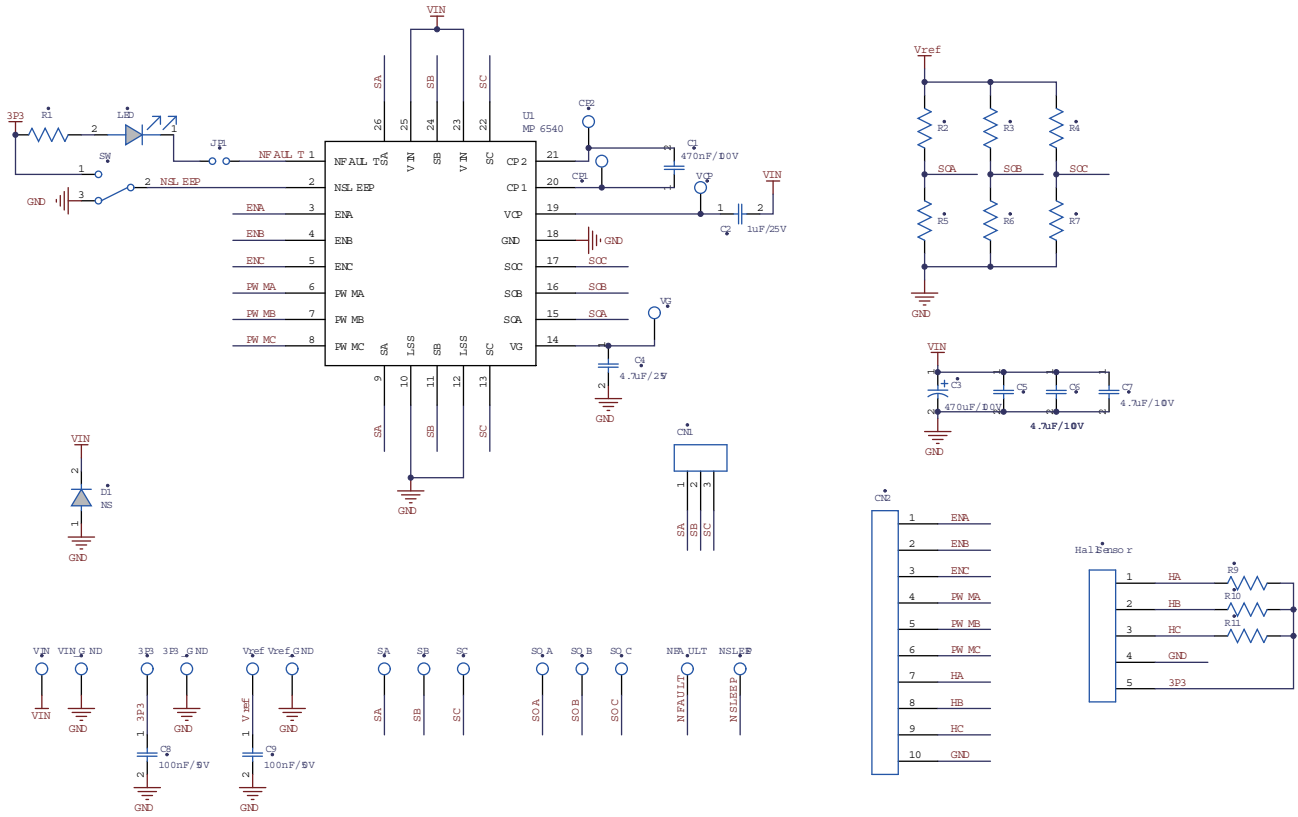

EV6540-U-00A BILL OF MATERIALS

Qty	RefDes	Value	Description	Package	Manufacturer	Manufacturer P/N
1	R1	499	Film Resistor; 1%	0603	Yageo	RC0603FR-07499RL
6	R2, R3, R4, R5, R6, R7	4.99K	Film Resistor; 1%	0603	Yageo	RC0603FR-074K99L
3	R9, R10, R11	1K	Film Resistor; 1%	0603	Yageo	RC0603FR-071KL
1	C1	470nF/100V	Ceramic Capacitor; 100V; X7R;	0805	muRata	GRM21BR72A474KA73L
1	C2	1μF/25V	Ceramic Capacitor; 25V; X7R	0603	muRata	GRM188R71E105KA12D
1	C3	470μF/100V	Electrolytic Capacitor; 100V;	DIP	江海	CD263-100V470
1	C4	4.7μF/25V	Ceramic Capacitor; 25V; X6S	0603	muRata	GRM188C81E475KE11D
3	C5, C6, C7	4.7μF/100V	Ceramic Capacitor;100V;X7 S	1210	muRata	GRJ32DC72A475KE11L
2	C8, C9	100nF/50V	Ceramic Capacitor; 50V; X7R	0603	Murata	GCJ188R71H104KA12D
1	LED	BL-HUE35A- AV-TRB	LED;红光;	0805	Bai Hong	2012SURC-11
2	CN1, CP1, CP2, VCP		CONN/3PIN/2.54M M			
1	CN2		CONN/10PIN/2.54 MM			
1	Hall Sensor		CONN/5PIN/2.54M M			
1	SW		Button	DIP		SS-12D01EG4
1	JP1		CONN/2PIN/2MM			
1	JP1		2mm Short Jumper			
6	NFAULT, NSLEEP, SOA, SOB, SOC, VG		Test Point			
2	VIN, VIN_GND		2.0 公针			
7	3P3, 3P3_GND , SA, SB, SC, Vref, Vref_GN D		1.0 公针			
1	D1	NS				
1	U1	MP6540	Three-phase BLDC Motor Driver	QFN26 (5x5mm)	MPS	MP6540GU

PRINTED CIRCUIT BOARD LAYOUT

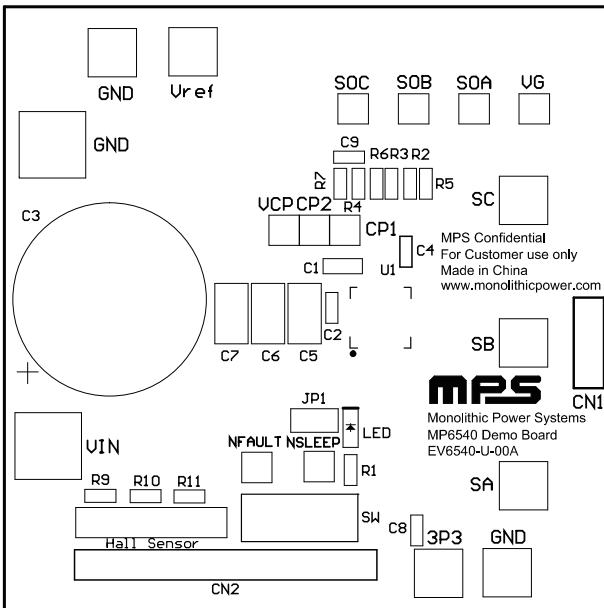

Figure 1—Top Silk Layer

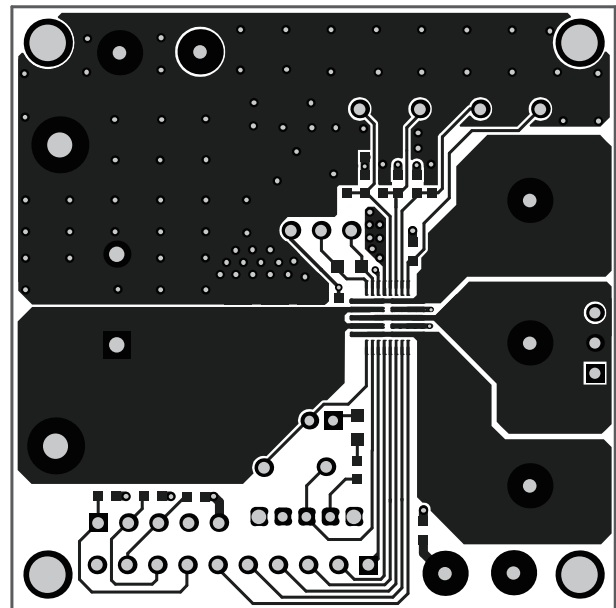

Figure 2—Top Layer

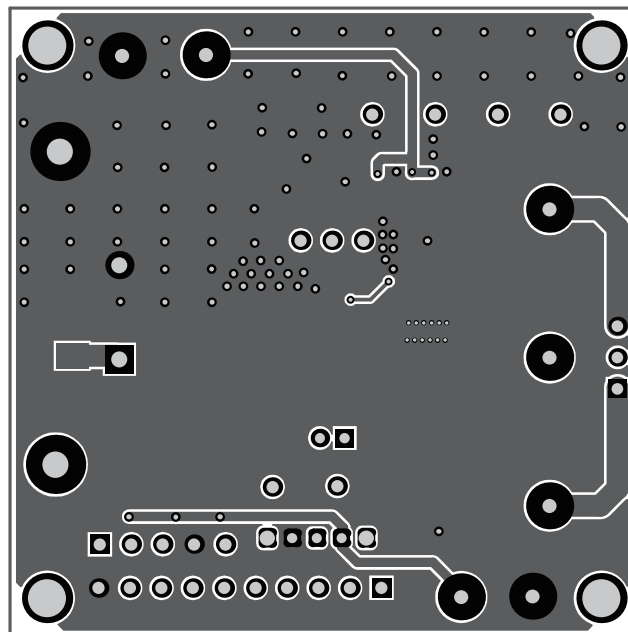

Figure 3—Bottom Layer

QUICK START GUIDE

1. Attach the input voltage ($5.5V \leq V_{IN} \leq 35V$) and input ground to the VIN and GND connectors respectively.
2. Attach a 3.3V or 5V constant voltage to the 3P3 connector and switch the SW1 to the position 1(right side) to enable the chip.
3. Attach a 3.3V or 5V constant voltage to the VREF connector to set the current sense output reference voltage.
4. Attach the hall signals coming from the motor to the Hall Sensor connector.
5. Attach the driving control signals generated by the external controller to the CN2 connector.

NOTICE: The information in this document is subject to change without notice. Users should warrant and guarantee that third party Intellectual Property rights are not infringed upon when integrating MPS products into any application. MPS will not assume any legal responsibility for any said applications.