

DESCRIPTION

The EV6537-V-00A is an evaluation board for the MP6537, a three-phase BLDC motor pre-driver.

It operates from a supply voltage of up to 100V. It is configured to drive 3 half bridges consisting of 6 N-channel Power MOSFETs. The rotor position information is provided by the Hall sensors assembled in the motor and the driving control signals are generated by the external controller, such as MCU, FPGA, etc.

ELECTRICAL SPECIFICATIONS

Parameter	Symbol	Value	Units
Input Voltage	VIN	8 - 100	V
OC_REF	OC_REF	0.125 – 2.4	V
Logic Power Supply	VCC	3.3 or 5	V

FEATURES

- Wide 8V to 100V Input Voltage Range
- Programmable OCP Threshold
- Support 100% Duty Cycle Operation
- OCP, OTP
- Fault Indication Output

APPLICATIONS

- 3-Phase Brushless DC Motors and Permanent Magnet Synchronous Motors
- Power Drills
- Impact Drivers
- E-Bike

All MPS parts are lead-free, halogen-free, and adhere to the RoHS directive. For MPS green status, please visit the MPS website under quality assurance. "MPS" and "The Future of Analog IC Technology" are registered trademarks of Monolithic Power Systems, Inc.

EV6537-V-00A EVALUATION BOARD

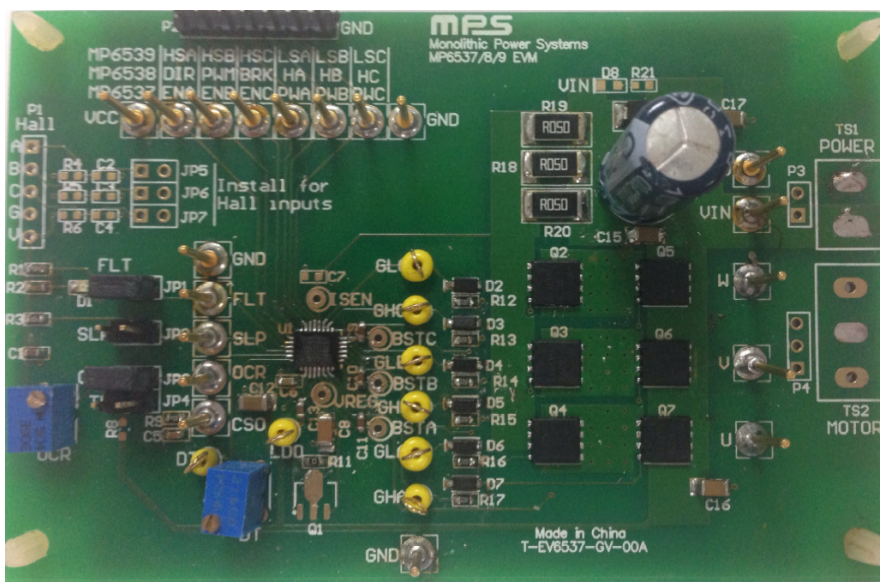

(L x W x H) 4.68" x 3.12" x 0.4"
(11.7cm x 7.8cm x 1cm)

Board Number	MPS IC Number
EV6537-V-00A	MP6537

EVALUATION BOARD SCHEMATIC

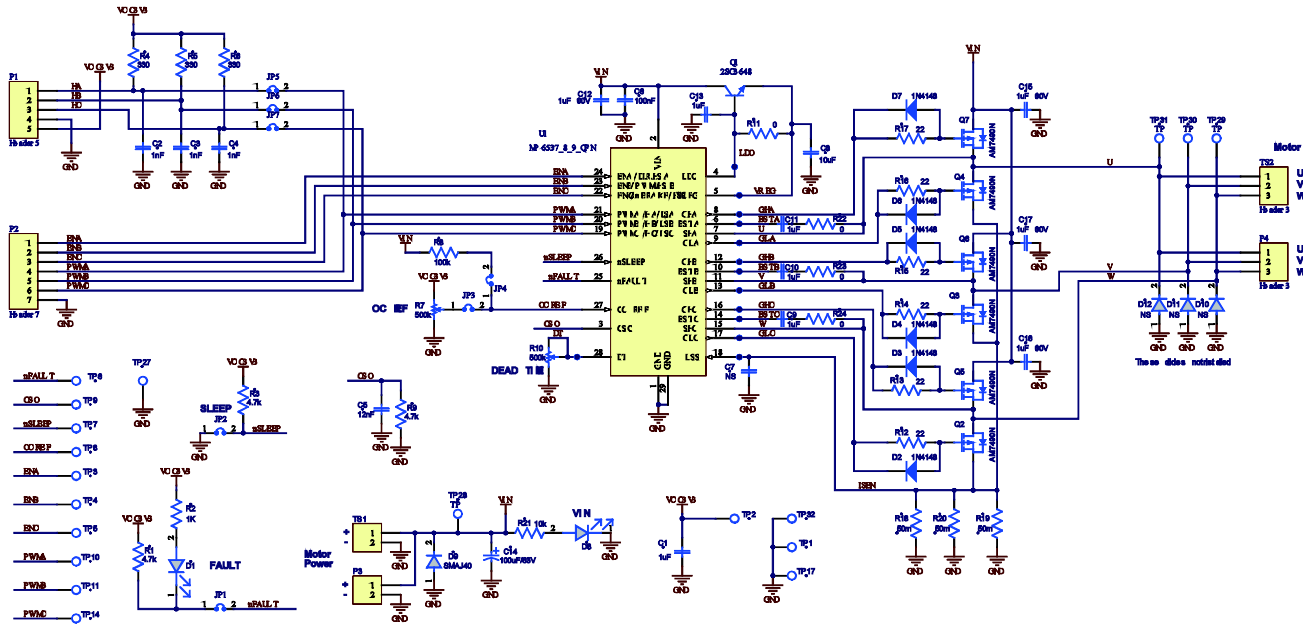

EV6537-V-00A BILL OF MATERIALS

Qty	RefDes	Value	Description	Package	Manufacturer	Manufacturer P/N
1	C1	1 μ F	Ceramic Cap. 6.3V, X5R	0603	Murata	GRM188R60J105KA01D
3	C2,C3,C4	1nF	Ceramic Cap. 16V, X7R	0603	Murata	GRM188R71C102KA01D
2	C5, C7	12nF	Ceramic Cap. 50V, X7R	0603	Murata	GRM188R71H123KA01D
1	C6	100nF	Ceramic Cap. 100V, X7R	0603	Murata	GRM188R72A104KA35D
1	C8	10 μ F	Ceramic Cap. 25V, X7R	1206	Murata	GRM31CR71E106KA12
4	C9, C10, C11, C13	1 μ F	Ceramic Cap. 25V, X7R	0603	Murata	GRM188R71E105KA12D
4	C12, C15, C16, C17	1 μ F	Ceramic Cap. 100V, X7R	1206	Murata	GRM31CR72A105KA01L
1	C14	100 μ F	Electrolytic Cap. 100V	DIP	Jianghai	CD263-100V100
6	R1, R3, R4, R5, R6, R9	4.7k	Film Resistor ,1%	0603	Yageo	RC0603FR-074K7L
1	R2	1k	Film Resistor ,1%	0603	Yageo	RC0603FR-071KL
2	R7, R10	500k	Adjustable Resistor	DIP		3266W-1-504LF
1	R8	100k	Film Resistor ,1%	0603	Yageo	RC0603FR-07100KL
4	R11, R22, R23, R24	0	Film Resistor ,1%	0603	Yageo	RC0603FR-070RL
6	R12, R13, R14, R15, R16, R17	22 Ω	Film Resistor ,1%	0603	Yageo	RC0603FR-0722RL
3	R18, R19, R20	50m Ω	Film Resistor ,1%	2512	Yageo	RL2512FK-070R05L
1	R21	10k	Film Resistor ,1%	0603	Yageo	RC0603FR-0710KL
2	D1, D8		LED. 绿光	0805	Bright LED	BL-HGE35A-TRB
6	D2, D3, D4, D5, D6, D7		Schottky Diode. 75V, 0.15A	SOD-123	Diodes	1N4148W
1	D9		TVS. 100V, 2.5A	SMA	Diodes	SMAJ100A
3	D10, D11, D12	NS				
1	Q1	NS				
6	Q2, Q3, Q4, Q5, Q6, Q7		N-channel MOSFET, 150V,8.3A, Qg=58nC,48mOhm	DFN5x6-8L	Analog Power	AM7490N
1	P1		5PIN. 2.54MM			
1	P2		7PIN. 2.54MM			
1	P3		2PIN. 2.54MM			
1	P4		3PIN. 2.54MM			
1	TS1		Header, 2-Pin			
1	TS2		Header, 3-Pin		Würth	691216510003
7	JP1, JP2, JP3, JP4, JP5, JP6, JP7		2PIN. 2.54MM(JP1, JP3 with Short Jumper)			

EV6537-V-00A BILL OF MATERIALS (continued)

Qty	RefDes	Value	Description	Package	Manufacturer	Manufacturer P/N
19	ENA, ENB, ENC, PWMA, PWMB, PWMC, VCC, GND, FLT, SLP, OCR, CSO, VIN, U, V, W		1.0 公针			
13	DT, LDO, VREG, ISEN, BSTA, BSTB, BSTC, GLA, GLB, GLC, GHA, GHB, GHC		Test Points			
1	U1		3-Phase BLDC Motor Pre-Driver	QFN- 28(4x5mm)	MPS	MP6537GV

PRINTED CIRCUIT BOARD LAYOUT

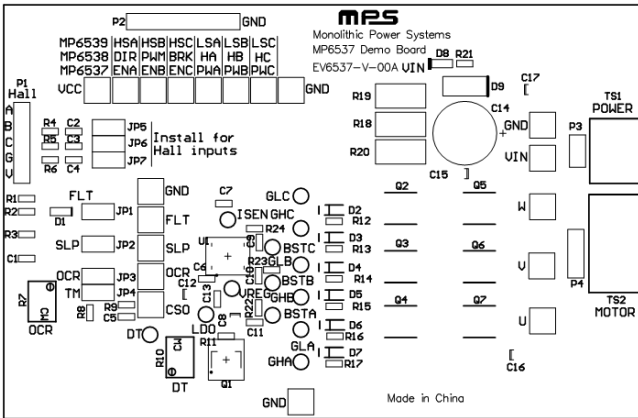

Figure 1—Top Silk Layer

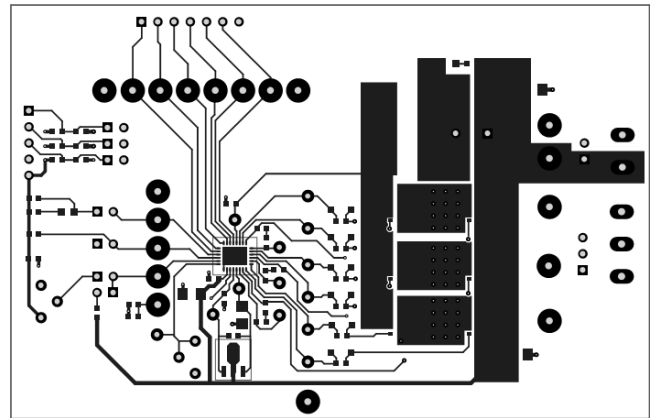

Figure 2—Top Layer

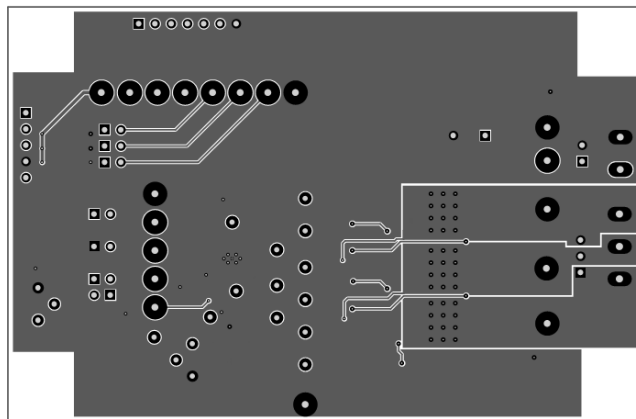

Figure 3—Bottom Layer

QUICK START GUIDE

1. Attach the input voltage ($8V \leq V_{IN} \leq 100V$) and input ground to the VIN and GND connectors respectively.
2. Attach a 3.3V or 5V constant voltage to the VCC terminal of the P1 connector.
3. Adjust R7 to give OCP reference voltage ($0.125V \leq V_{REF} \leq 2.4V$) to set OCP threshold.
4. Attach the driving control signals generated by the external controller to the P2 connector.

NOTICE: The information in this document is subject to change without notice. Users should warrant and guarantee that third party Intellectual Property rights are not infringed upon when integrating MPS products into any application. MPS will not assume any legal responsibility for any said applications.