



The Future of Analog IC Technology®

EV6420-J-00A

Battery Protection IC for 2-/3-Series Cell Li-Ion with Protective MOSFET and PTC Interface

DESCRIPTION

The EV6420-J-00A is an evaluation board for the MP6420.

The MP6420 provides overcharge protection that integrates a protective, open-drain MOSFET for 2- or 3-series cell Li-ion power systems.

The MP6420 provides a $\pm 15\text{mV}$, high-accuracy, overcharge threshold to monitor all series' battery pack conditions. With the high-accuracy threshold, the MP6420 can provide different fixed thresholds from 4.2V to 4.8V internally. Any cell overcharge that occurs turns on the internal protective MOSFET to indicate the error after an internally set, fixed delay time.

The MP6420 is available in a small, space-saving TSOT23-8 package.

ELECTRICAL SPECIFICATION

Parameter	Symbol	Value	Units
Battery cells ⁽¹⁾	V_B	2-3	Serialize

Note:

1) For Specifications Of Lower Voltage, Please Contact Factory.

FEATURES

- Wide V_{B1} Range from 3.6V to 18V
- Fixed Overcharge Threshold from 4.2V to 4.8V
- High-Accuracy $\pm 15\text{mV}$ Overcharge Threshold
- Supports 2- and 3-Series Cells
- Fixed Delay Time from 2s to 8s
- Integrated 24V/100m Ω Protective MOSFETs
- Low Quiescent Current: 8 μA
- OVP Indicator FLAG and PTC Interface
- External Control CTL
- Available in a TSOT23-8 Package

APPLICATIONS

- Battery Pack
- UPS
- Power Tool

All MPS parts are lead-free, halogen free, and adhere to the RoHS directive. For MPS green status, please visit MPS website under Quality Assurance. "MPS" and "The Future of Analog IC Technology" are Registered Trademarks of Monolithic Power Systems, Inc.

EV6420-J-00A EVALUATION BOARD

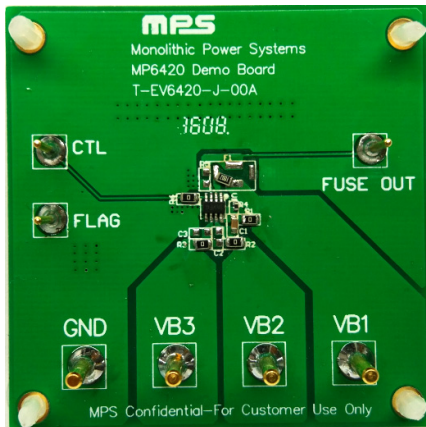

R_{DS_ON} vs. V_{CC}

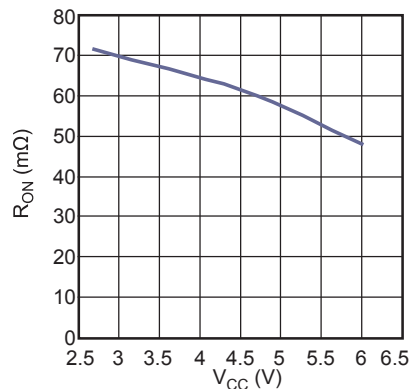

Board Number	MPS IC Number
EV6420-J-00A	MP6420GG

EVALUATION BOARD SCHEMATIC

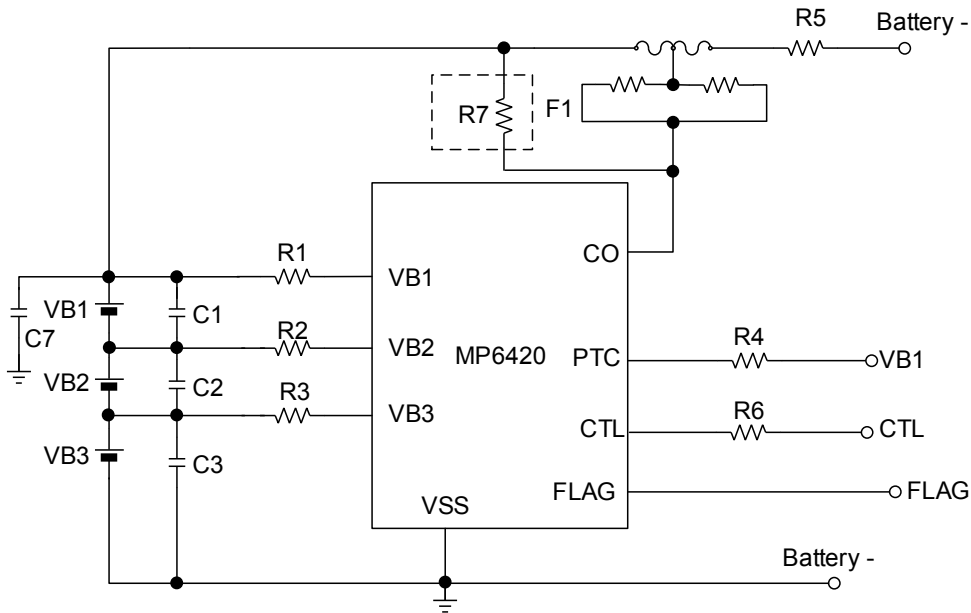

Note: R7 is the pull-up resistor of “CO” pin, just used for evaluation.

EV6420-J-00A BILL OF MATERIALS

Qty	Ref	Value	Description	Package	Manufacturer	Part Number
1	C1	1µF	Ceramic Cap,16V,X5R	0603	muRata	GRM188R61C105KA93D
0	C2, C3	NC	Film Res,1%	0603		
5	R1,R2, R3, R5, R6	0Ω	Film Res,1%	0603	any	
1	R4	10k		0603	any	
0	F1	NC				
1	R7	10k		0603	any	
1	U1	MP6420	Battery Protection IC	TSOT23-8	MPS	MP6420

EVB TEST RESULTS

Performance waveforms are tested on the evaluation board.

V_{B1} to $V_{B2}=V_{B2}$ to $V_{B3}=V_{B3}$ to $V_{SS}=4V$ with $10k\Omega$ resistor between V_{B1} and PTC, $T_J = 25^\circ C$, unless otherwise noted.

PTC Response

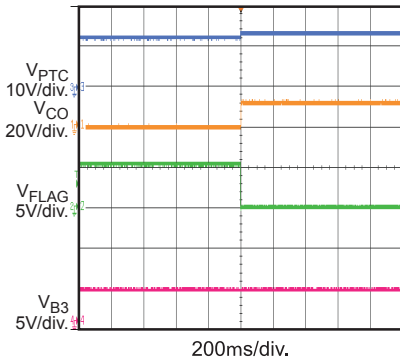

PTC Response

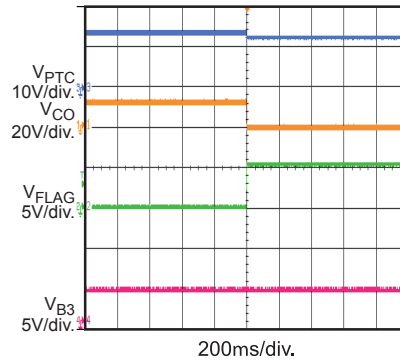

CTL Response

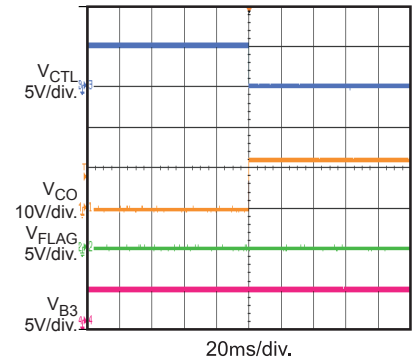

CTL Response

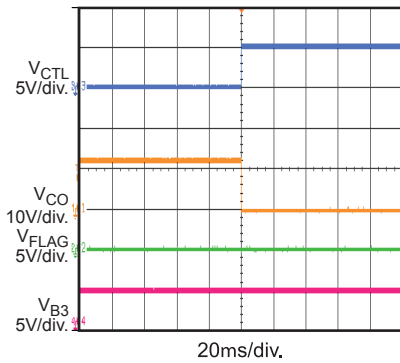

OVP Response

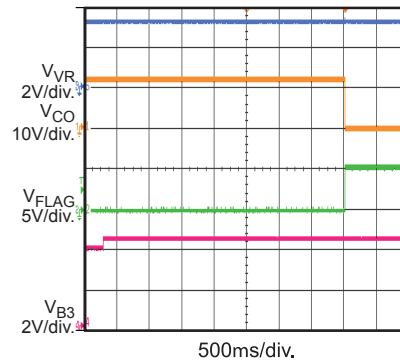

OVP Recovery Delay

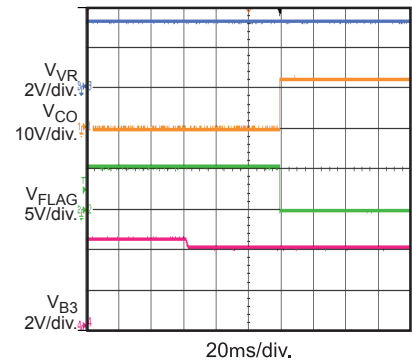

OVP Not Recovery

V_{B1} to $V_{B2}=V_{B2}$ to $V_{B3}=4V$

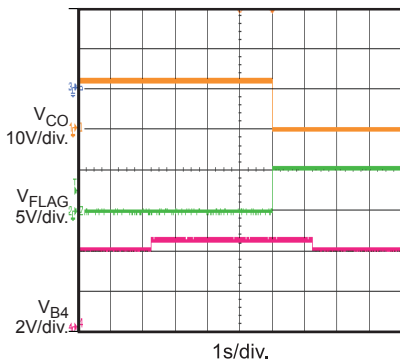

OVP Recovery

V_{B1} to $V_{B2}=V_{B2}$ to $V_{B3}=3.9V$

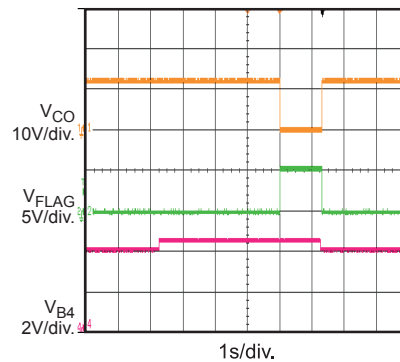

PRINTED CIRCUIT BOARD LAYOUT

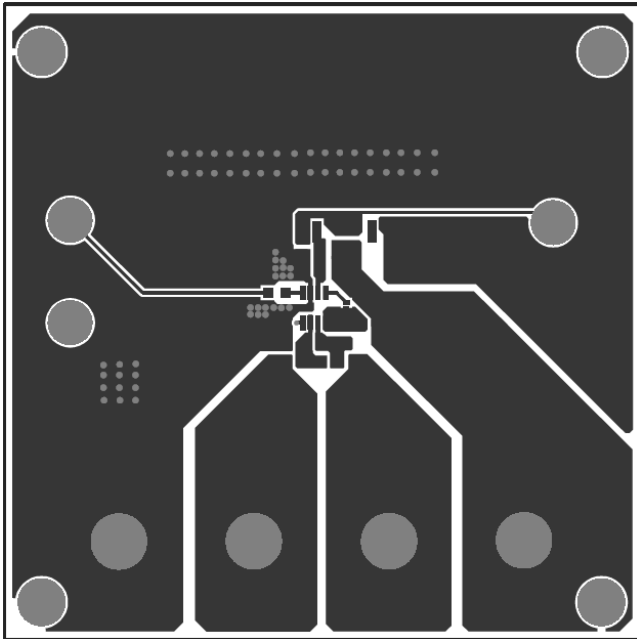

Figure 1 - Top Layer

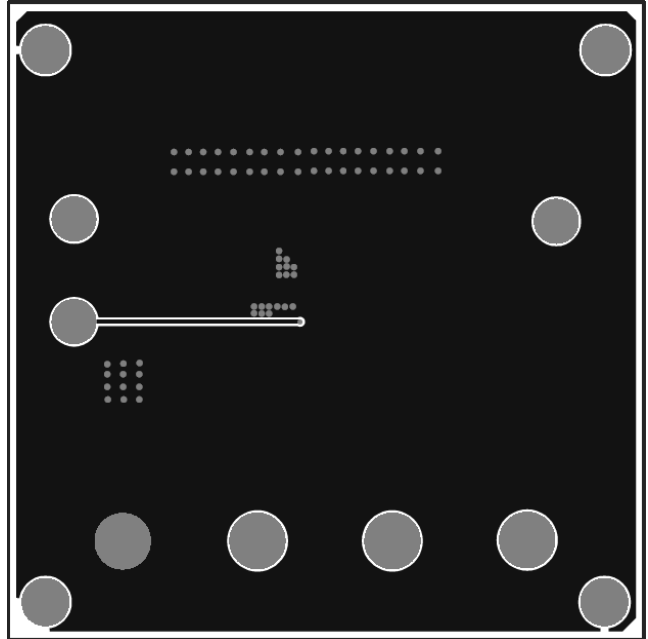

Figure 2 - Bottom Layer

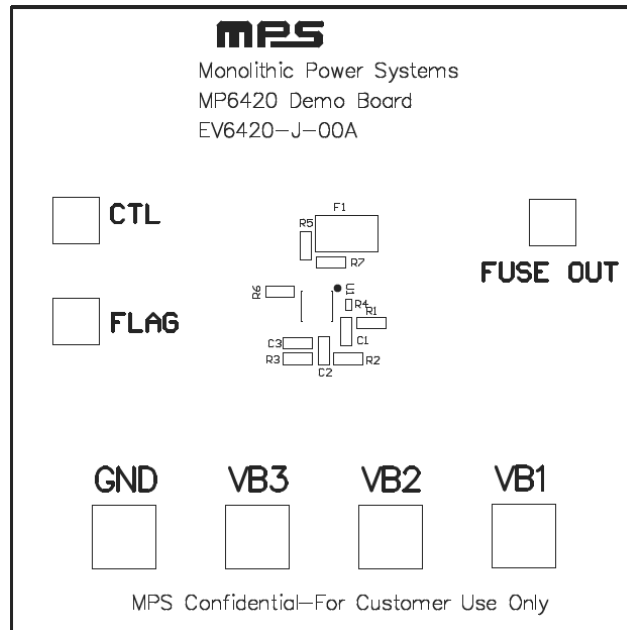

Figure3 - Bottom Layer

QUICK START GUIDE

This board is design for 2 or 3 series cell Li-ion battery.

(if power sources are using to similar the Li-ion battery, please make sure the voltage of each channel should be between 3.6V and 6V. Then turn them off).

1. Connect the **anode** of cell-1 to VB3 and **cathode** to GND or connect **positive (+)** of power source to VB3, **negative (-)** to GND if you are using power source;
2. Connect the anode of cell-2 to VB2 and cathode to VB3 or connect **positive (+)** of power source to VB2, **negative (-)** to VB3;
3. Connect the anode of cell-3 to VB1 and cathode to VB2 or connect **positive (+)** of power source to VB1, **negative (-)** to VB2;
4. Turn them on if you are using power source (ignore this step if the power supplies are batteries) and the board is working now.
5. You can monitor the FLAG and try to increase one cell voltage to higher than 4.45V and wait 4s to see if FLAG turn high (more function please refer the datasheet).

NOTICE: The information in this document is subject to change without notice. Please contact MPS for current specifications. Users should warrant and guarantee that third party Intellectual Property rights are not infringed upon when integrating MPS products into any application. MPS will not assume any legal responsibility for any said applications.