

DESCRIPTION

EV6004-Q-00A Evaluation Board is designed to demonstrate the capability of MP6004's primary-side regulate fly-back function. The MP6004 is a monolithic DC-DC converter which includes 180V power switch and targets isolated or non-isolated 13W PoE application.

MP6004 uses fixed peak current and variable frequency discontinuous conduction mode (DCM) to regulate constant output voltage. Primary-side-regulate without opto-coupler feedback in flyback mode simplify the design and save BOM cost. 180V integrated power MOSFET optimizes it for various wide voltage applications.

The MP6004 also features protection including over load, over voltage, open circuit and thermal shutdown.

The MP6004 is available in QFN-14 3mmX3mm package.

ELECTRICAL SPECIFICATIONS

Parameter	Symbol	Value	Units
Input voltage	V_{IN}	36-72	V
Output voltage	V_{OUT}	12	V
Output current	I_{OUT}	1	A
Programmed I_{PEAK}	I_{PEAK}	2.05	A

FEATURES

- Primary-side Regulate Flyback without Opto-coupler Feedback
- Integrated 180V Switching Power MOSFET
- Internal 80V Startup Circuit
- Up to 3A Programmable Current Limit
- Discontinuous Conduction Work Mode
- Include OLP, OVP, Open Circuit and Thermal Protection
- Flexible Self-power or External V_{CC} Power
- Minimal External Components Count
- Available in QFN-14 3mmx3mm Package

APPLICATIONS

- Security Camera
- VoIP Phones
- WLAN Access Points
- General Flyback Converter

All MPS parts are lead-free, halogen free, and adhere to the RoHS directive. For MPS green status, please visit MPS website under Quality Assurance.

"MPS" and "The Future of Analog IC Technology" are Registered Trademarks of Monolithic Power Systems, Inc.

EV6004-Q-00A EVALUATION BOARD



(L x W x H) (6.35cm x 3.2cm x 1.5cm)

Board Number	MPS IC Number
EV6004-Q-00A	MP6004GQ

Efficiency

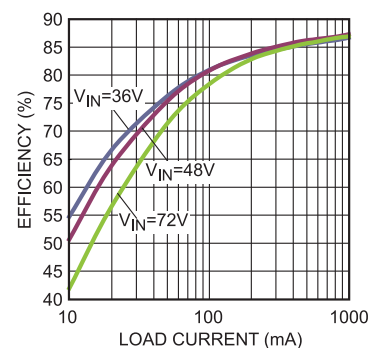

EVALUATION BOARD SCHEMATIC

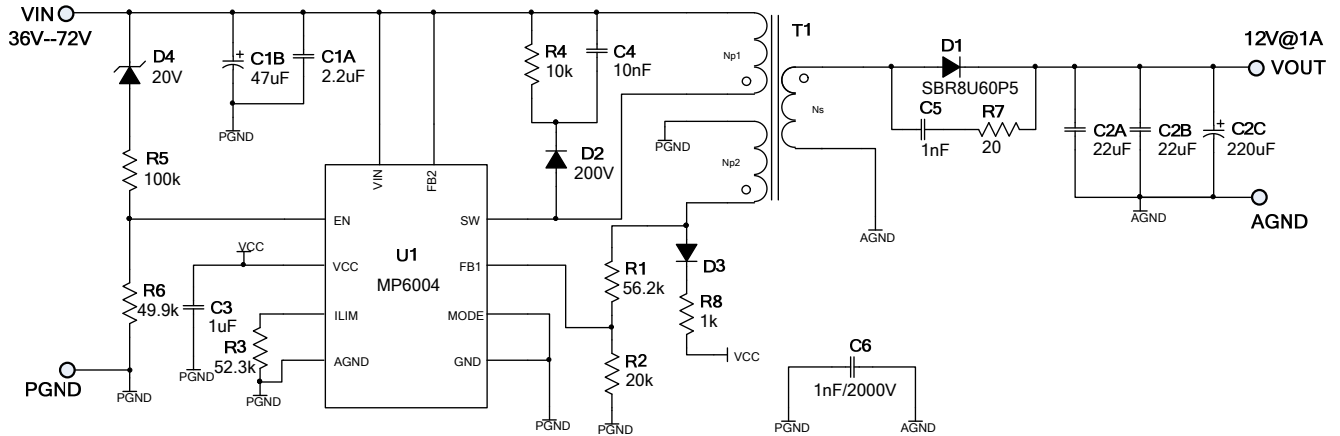

EV6004-Q-00A BILL OF MATERIALS

Qty	Ref	Value	Description	Package	Manufacturer	Part Number
1	C1A	2.2µF	Ceramic Cap., 100V, X7R	1210	muRata	GRM32ER72A225KA35L
1	C1B	47µF	47µF 100V CD284 E-Cap 10X12.5mm	DIP	JiangHai	47uF/100V
2	C2A,C2B	22µF	Ceramic Cap.,25V,X7R	1210	muRata	GRM32ER71E226KE15L
1	C2C	220µF	220µF 25V CD284 E-Cap 8X12.5mm	DIP	JiangHai	22uF/25V
1	C3	1µF	Ceramic Cap,10V,X7R	0603	muRata	GRM188R71A105KA61D
1	C4	10nF	Ceramic Cap,100V,X7R	0805	muRata	GRM216R72A103KA01D
1	C5	1nF	Ceramic Cap,100V,X7R	0603	muRata	GRM188R72A102KA01D
1	C6	1nF	Ceramic Cap. 2000V X7R	1808	muRata	GR442QR73D102KW01L
1	R1	56.2k	Film Res,1%	0603	ROYAL	RC0603FR-0756K2L
1	R2	20k	Film Res,1%	0603	ROYAL	RC0603FR-0720KL
1	R3	52.3k	Film Res,1%	0603	ROYAL	RC0603FR-0752K3L
1	R4	10k	Film Res,5%	1206	ROYAL	RC1206JR-0710KL
1	R5	100k	Film Res,1%	0603	ROYAL	RC0603FR-07100KL
1	R6	49.9k	Film Res,1%	0603	ROYAL	RC0603FR-0749K9L
1	R7	20Ω	Film Res,5%	0805	ROYAL	RC0805JR-0720RL
1	R8	1k	Film Res,1%	0603	ROYAL	RC0603FR-071KL
1	D1	SBR8U60P5	8A 60V SUPER BARRIER RECTIFIER	POWERDI5	Diodes	SBR8U60P5
1	D2	BAV21	Switching Diode 200V 200mW	SOD-123	Diodes	BAV21W-7-F
1	D3	1N4148	Switching Diode 75V 250mW	SOD-323	Diodes	1N4148WS-7
1	D4	BZT52C20	20V zener	SOD-123	Diodes	WBZT52C20
1	T1	47.4µH	Np:Ns:Na=22:10:6, Lp=47.4µH, Core=EE13	EE13	EMEI	POE12W12V

EVB TEST RESULTS

$V_{IN}=48V$, $V_{OUT}=12V$, $I_{OUT}=1A$, $T_A=25^{\circ}C$, unless otherwise noted.

Efficiency

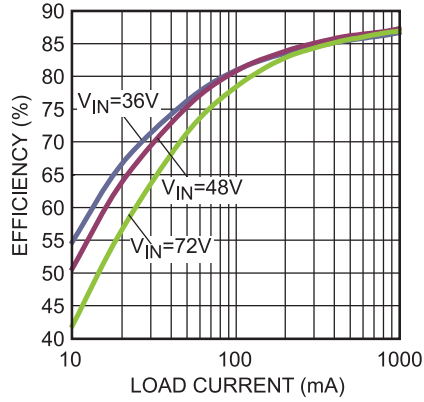

Load Regulation

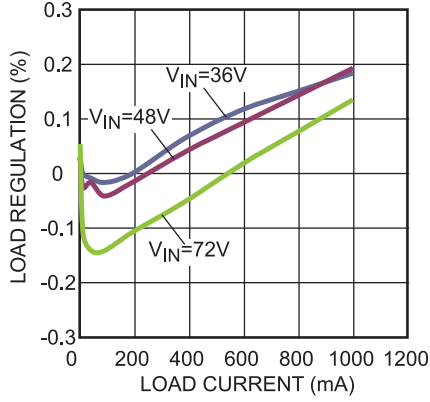

Line Regulation

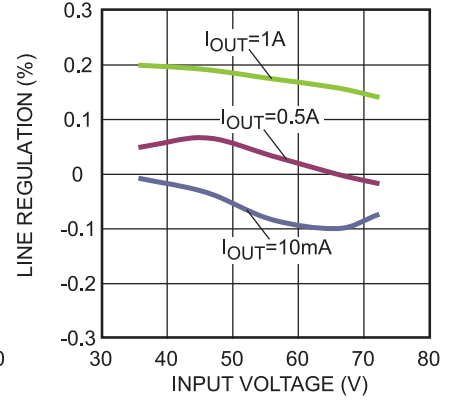

Case Temperature Rise

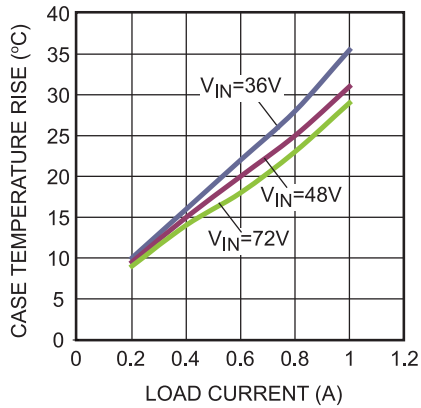

EVB TEST RESULTS (continued)

$V_{IN}=48V$, $V_{OUT}=12V$, $I_{OUT}=1A$, $T_A=25^{\circ}C$, unless otherwise noted.

Steady State

$I_{OUT} = 10mA$

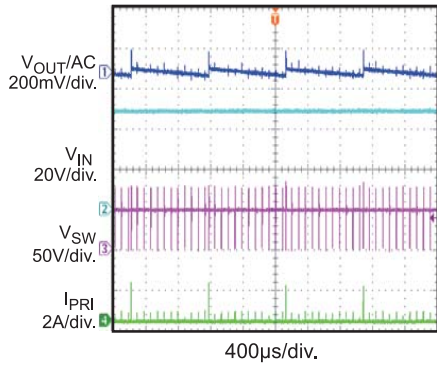

Steady State

$I_{OUT} = 100mA$

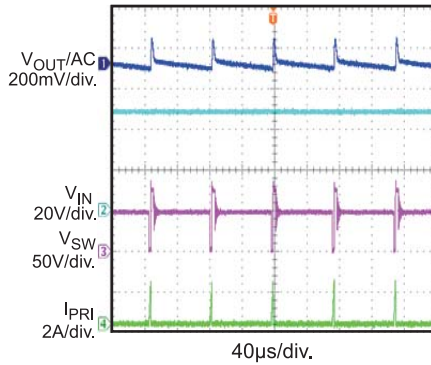

Steady State

$I_{OUT} = 1A$

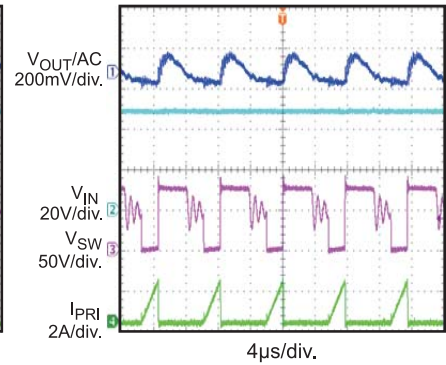

VIN Start-Up

$I_{OUT} = 10mA$

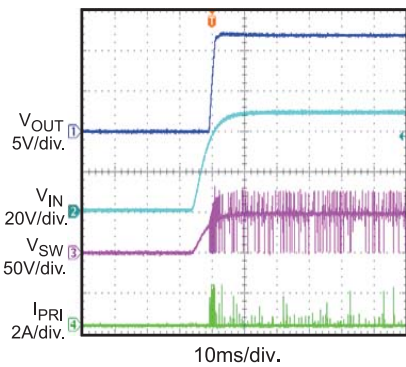

VIN Start-Up

$I_{OUT} = 1A$

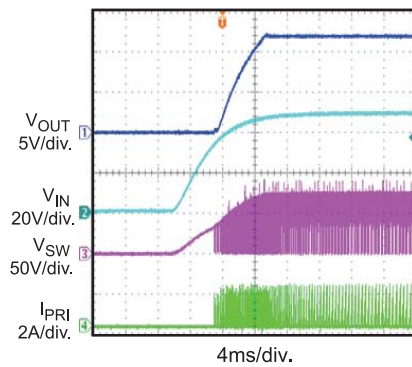

VIN Shutdown

$I_{OUT} = 10mA$

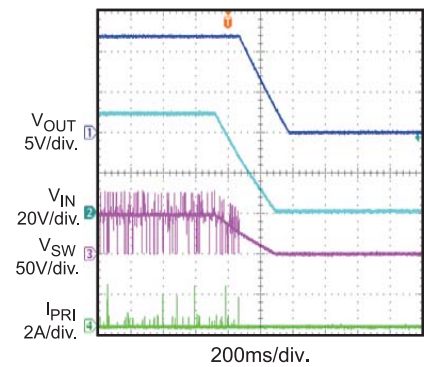

VIN Shutdown

$I_{OUT} = 1A$

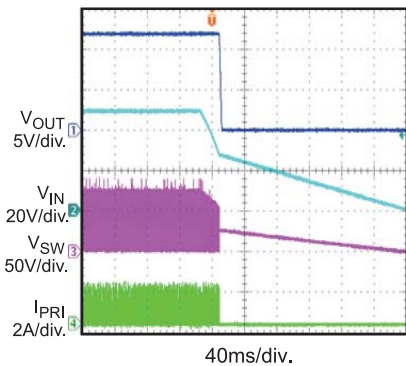

EN Start-Up

$I_{OUT} = 10mA$

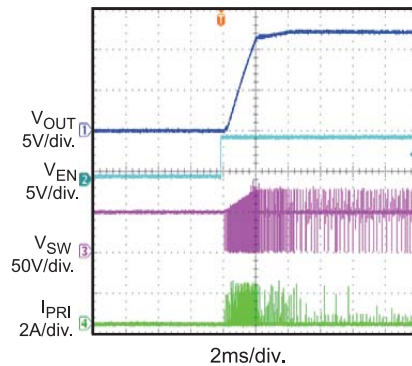

EN Start-Up

$I_{OUT} = 1A$

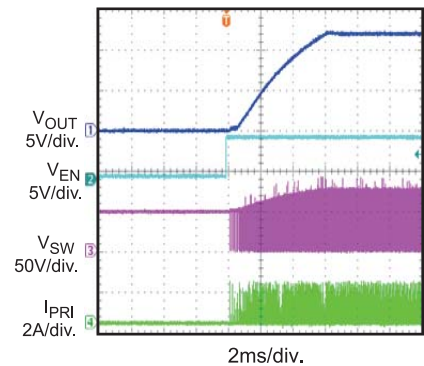

EVB TEST RESULTS (continued)

$V_{IN}=48V$, $V_{OUT}=12V$, $I_{OUT}=1A$, $T_A=25^{\circ}C$, unless otherwise noted.

EN Shutdown

$I_{OUT} = 10mA$

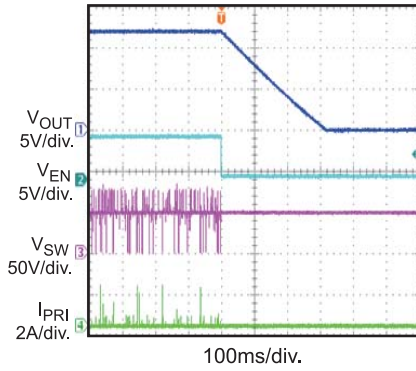

EN Shutdown

$I_{OUT} = 1A$

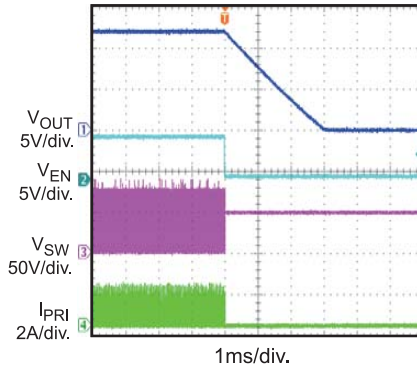

SCP Entry

$I_{OUT} = 10mA$

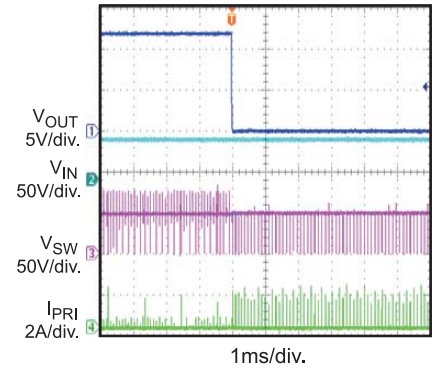

SCP Entry

$I_{OUT} = 1A$

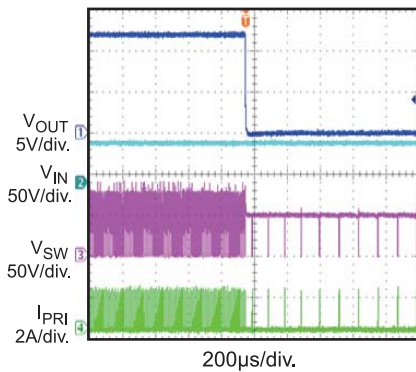

SCP Recovery

$I_{OUT} = 10mA$

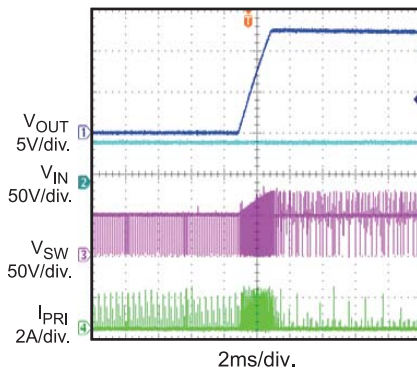

SCP Recovery

$I_{OUT} = 1A$

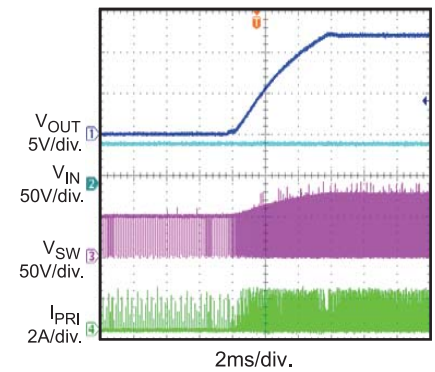

Load Transient

$I_{OUT} = 10mA$ to $0.5A$,
 $I_{RAMP} = 25mA/\mu s$

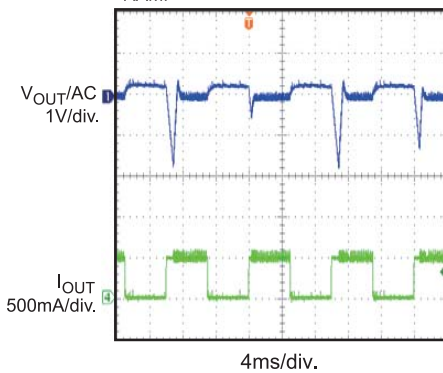

Load Transient

$I_{OUT} = 0.5A$ to $1A$,
 $I_{RAMP} = 25mA/\mu s$

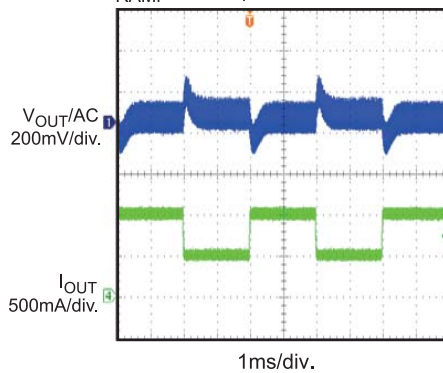

OVP

$I_{OUT} = 100mA$ to $2mA$

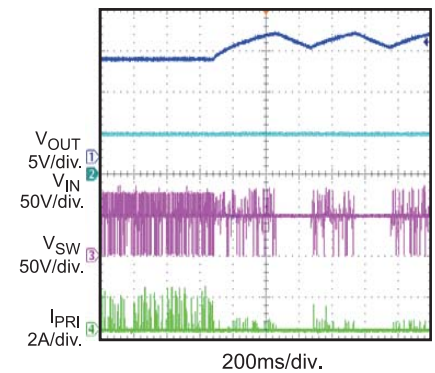

EVB TEST RESULTS (continued)

$V_{IN}=48V$, $V_{OUT}=12V$, $I_{OUT}=1A$, $T_A=25^{\circ}C$, unless otherwise noted.

FB1 Open Circuit Entry
 $I_{OUT} = 1A$

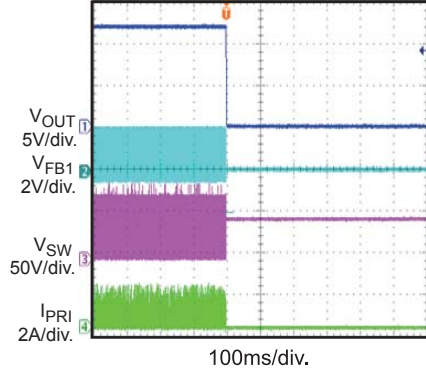

FB1 Open Circuit Recovery
 $I_{OUT} = 1A$

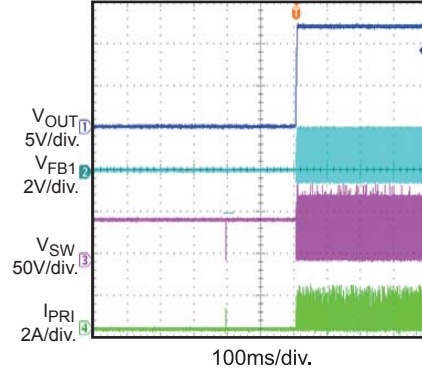

PRINTED CIRCUIT BOARD LAYOUT

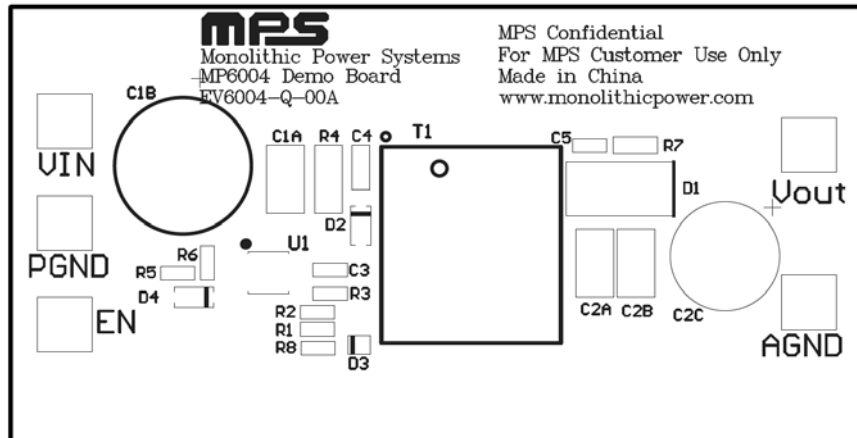

Figure 1: Top Silk Layer

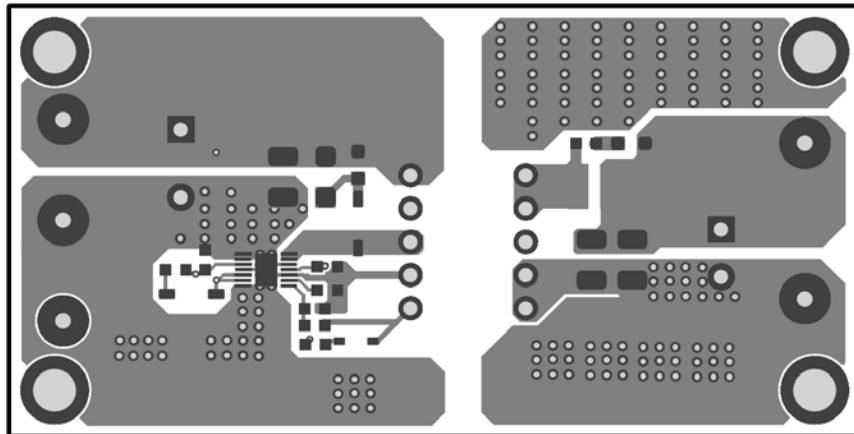

Figure 2: Top Layer

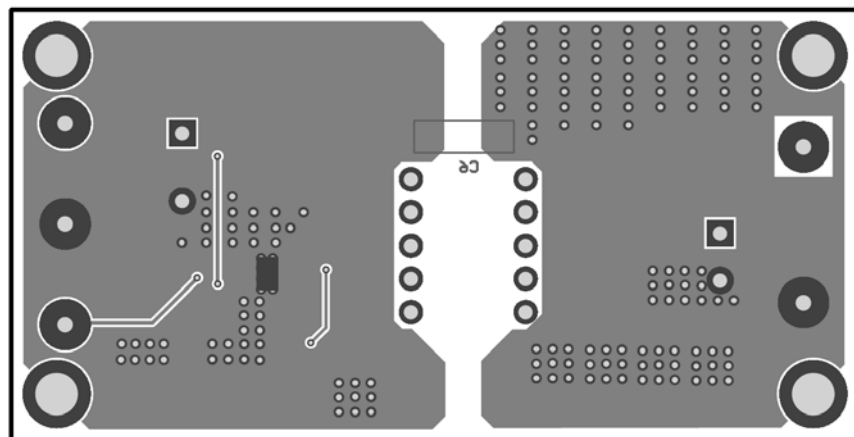

Figure 3: Bottom Layer

QUICK START GUIDE

The output voltage of this board is set to 12V. The board layout accommodates most commonly used components.

1. Preset Power Supply to $36V \leq V_{IN} \leq 72V$.
2. Turn Power Supply off.
3. Connect Power Supply terminals to:
 - a. Positive (+): VIN
 - b. Negative (-): PGND
4. Connect Load to:
 - a. Positive (+): VOUT
 - b. Negative (-): AGND
5. Turn Power Supply on after making connections.
6. The MP6004 is enabled on the evaluation board once VIN is applied.
7. To use the Enable function, apply a digital input to the EN pin. Drive EN higher than 3.9V to turn on EV6004-Q-00A or less than 1.3V to turn it off.
8. MP6004 can supply V_{CC} through internal high voltage LDO, D3 and R8 can be removed to save BOM cost, while it may lead to 0.2% efficiency decreasing.
9. If testing EV6004-Q-00A in no load condition, please add about 10mA dummy load for good regulation and avoiding MP6004 enter OVP protection.

NOTICE: The information in this document is subject to change without notice. Users should warrant and guarantee that third party Intellectual Property rights are not infringed upon when integrating MPS products into any application. MPS will not assume any legal responsibility for any said applications.