

DESCRIPTION

EV5512-V-00A Evaluation Board is designed to demonstrate the capabilities of MP5512. MP5512 is a peak power assist device intelligently designed for use in solid state drives and smart speakers.

MP5512 supports input hot-swap, input reverse current protection, input power failure indication and high efficient power backup. The built-in boost mode converter charges storage bulk capacitors to a programmed voltage while the system is powered up. For smart speakers, during peak power consumption, MP5512 supplies additional energy to the system to prevent browning out and system reset. For SSDs, in the case of input power failure, MP5512 transfers energy to support system data backup.

MP5512 is available in QFN28-4x5mm package.

ELECTRICAL SPECIFICATION

Parameter	Symbol	Value	Units
Input Voltage	V_{IN}	12	V
Storage Voltage	V_{STRG}	35	V
Input Pfail Threshold	V_{PFI}	6.1	V
Bus Backup Voltage	V_{RLS}	7.8	V
Bus Backup Max Load	$I_{RELEASE}$	3	A

FEATURES

- Wide 4V to 18V Operating Input Range
- Programmable up to 40V Storage Voltage
- Up to 4.5A Input Current Limit
- Input Reverse Current Protection
- Adjustable Slew Rate for VB Start-up Rising
- 14mΩ MOSFET for Input Hot-swap
- High Efficiency Power Backup with Internal 140mΩ and 110mΩ Power Switches
- Input Failure Indicator and Input Early Warning for V_{IN}
- Programmable Input Current Limit and Current Monitor
- Stable Work with 0.1μF Input Capacitor for Hot-swap
- Thermal Protection
- Available in a QFN28 (4mm×5mm) Package

APPLICATIONS

- Peak Power Smoother for Smart Speakers
- Artificial Intelligence (AI)-Enabled Speakers
- Solid-State Drives
- Hard-Disk Drives
- Power Back-up Systems

All MPS parts are lead-free, halogen free, and adhere to the RoHS directive. For MPS green status, please visit MPS website under Quality Assurance.

"MPS" and "The Future of Analog IC Technology" are Registered Trademarks of Monolithic Power Systems, Inc.

EV5512-V-00A EVALUATION BOARD



(L x W x H) 6.35cm x 6.35cm x 1.4cm

Board Number	MPS IC Number
EV5512-V-00A	MP5512GV

VSTRG Release

$P_B=20W$, $C_{STRG}=150\mu F$

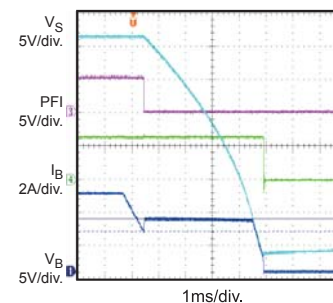

EVALUATION BOARD SCHEMATIC

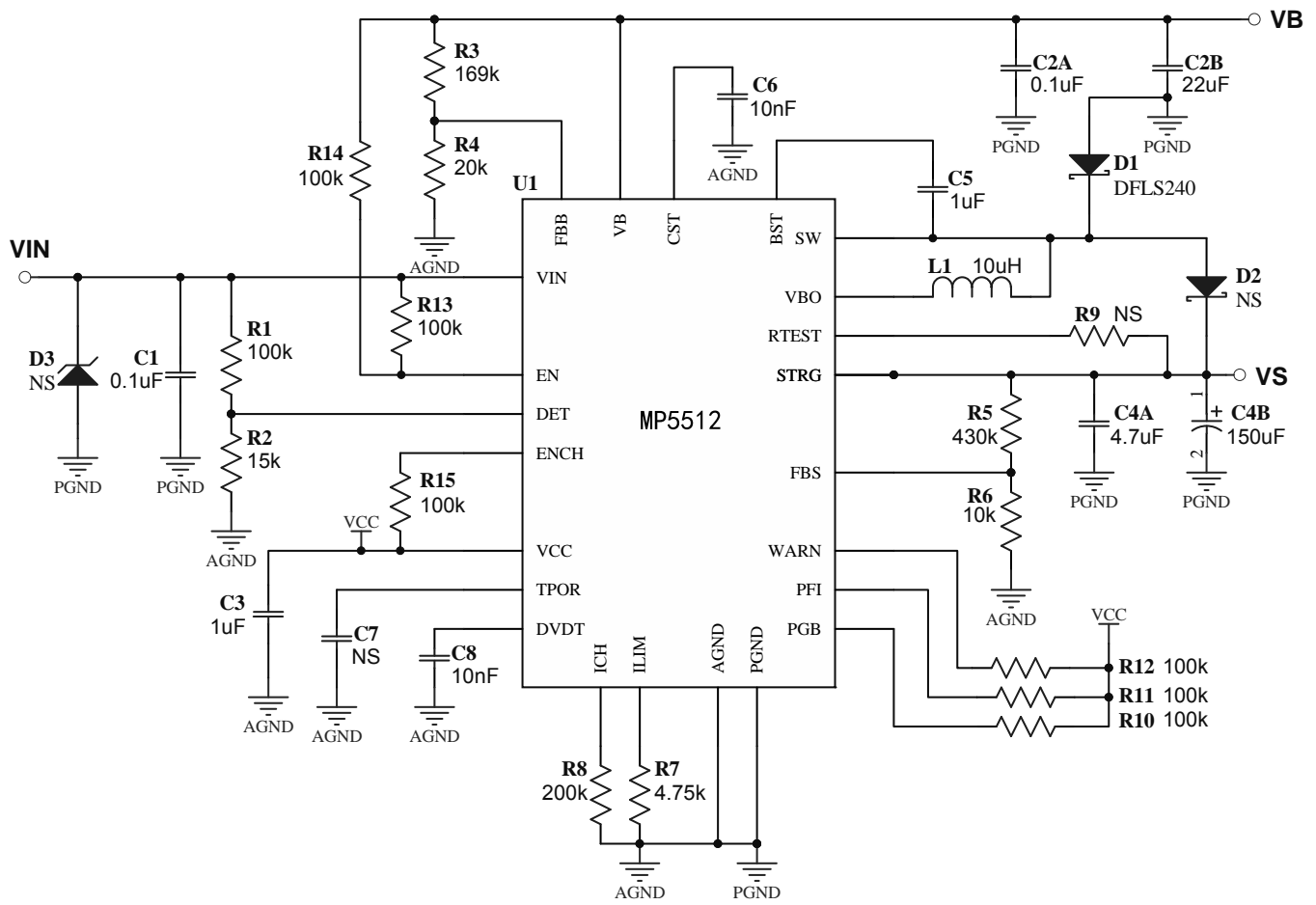

Note:

- 1) Schottky diode D1 is required in all applications.

EV5512-V-00A BILL OF MATERIALS

Qty	Ref	Value	Description	Package	Manufacturer	Part Number
2	C1, C2A	0.1µF	Ceramic Cap., 25V, X7R	0603	Murata	GRM188R71E104KA01D
1	C2B	22µF	Ceramic Cap., 25V, X7R	1206	Murata	GRM31ER71E226KE15L
2	C3, C5	1µF	Ceramic Cap., 10V, X5R	0402	Murata	GRM155R61A105KE15D
1	C4A	4.7µF	Ceramic Cap., 50V, X7R	1206	Murata	GRM31CR71H475KA12L
1	C4B	150µF	Electrolytic Cap., 50V	DIP	JiangHai	CD284
2	C6, C8	10nF	Ceramic Cap., 50V, X7R	0402	Murata	GRM155R71H103KA88D
0	C7	NS				
1	D1	DFLS240L	Schottky Diode, 40V, 2A	PowerDI123	Diodes	DFLS240L-7
0	D2, D3	NS				
1	L1	10µH	Inductor, I _{SAT} =4.9A, 41mΩ	SMD	Coilcraft	XAL5050-103ME
7	R1, R10, R11, R12, R13, R14, R15	100kΩ	Film Res., 1%	0402	Yageo	RC0402FR07100KL
1	R2	15kΩ	Film Res., 1%	0402	Yageo	RC0402FR0715KL
1	R3	169kΩ	Film Res., 1%	0402	Yageo	RC0402FR07169KL
1	R4	20kΩ	Film Res., 1%	0402	Yageo	RC0402FR0720KL
1	R5	430kΩ	Film Res., 1%	0402	Yageo	RC0402FR07430KL
1	R6	10kΩ	Film Res., 1%	0402	Yageo	RC0402FR0710KL
1	R7	4.75kΩ	Film Res., 1%	0402	Yageo	RC0402FR074K75L
1	R8	200kΩ	Film Res., 1%	0402	Yageo	RC0402FR07200KL
0	R9	NS				
1	U1	MP5512	Energy Storage and Management Unit	QFN28 4x5	MPS	MP5512GV

EVB TEST RESULTS

Performance waveforms are tested on the evaluation board.

$V_{IN} = 12V$, $V_{STRG} = 35V$, $V_{PFI} = 6.1V$, $V_{RLS} = 7.8V^{(2)}$, $L = 10\mu H$, $T_A = 25^\circ C$, $P_{OUT} = 20W$, unless otherwise noted.

V_{IN} Power On

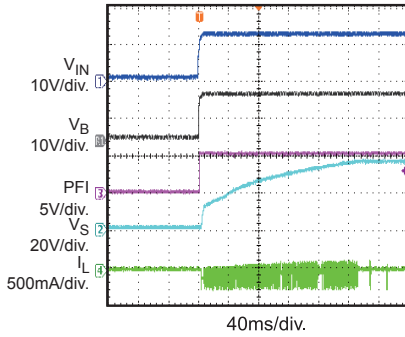

EN Power On

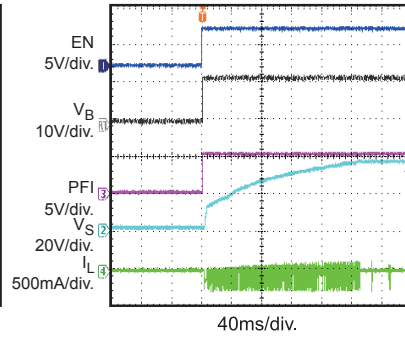

ENCH Power On

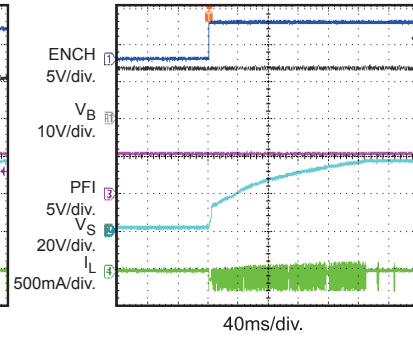

V_{STRG} Release

$P_B=20W$, $C_{STRG}=150\mu F$

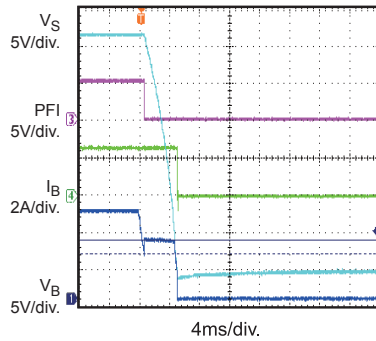

V_{STRG} Release

$P_B=10W$, $C_{STRG}=150\mu F$

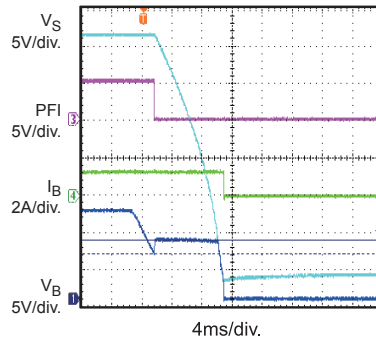

V_{STRG} Release

$P_B=5W$, $C_{STRG}=150\mu F$

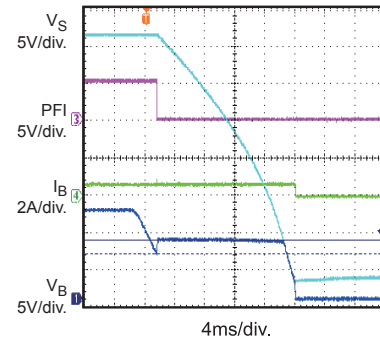

V_{STRG} Release

$P_B=20W$, $C_{STRG}=2200\mu F$

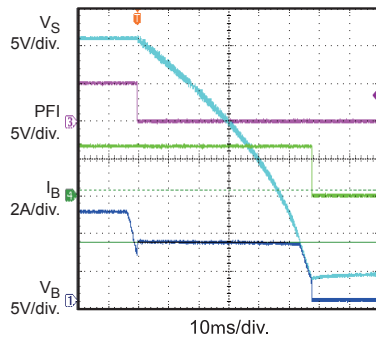

V_{STRG} Release

$P_B=20W$, $C_{STRG}=1000\mu F$

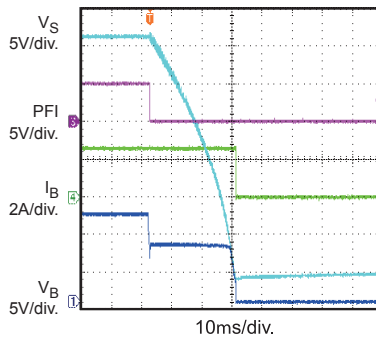

V_{STRG} Release

$P_B=20W$, $C_{STRG}=440\mu F$

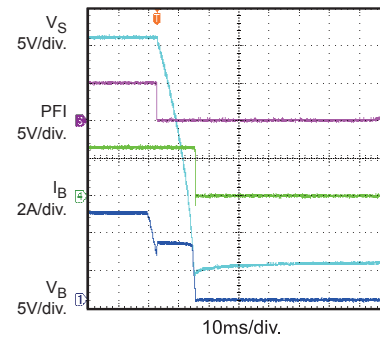

Note:

- V_{RLS} voltage varies a little with different V_{STRG} voltage because the internal RAMP voltage on FBB changes with duty cycle. 7.8V voltage is estimated based on 30V V_{STRG} condition.

PRINTED CIRCUIT BOARD LAYOUT

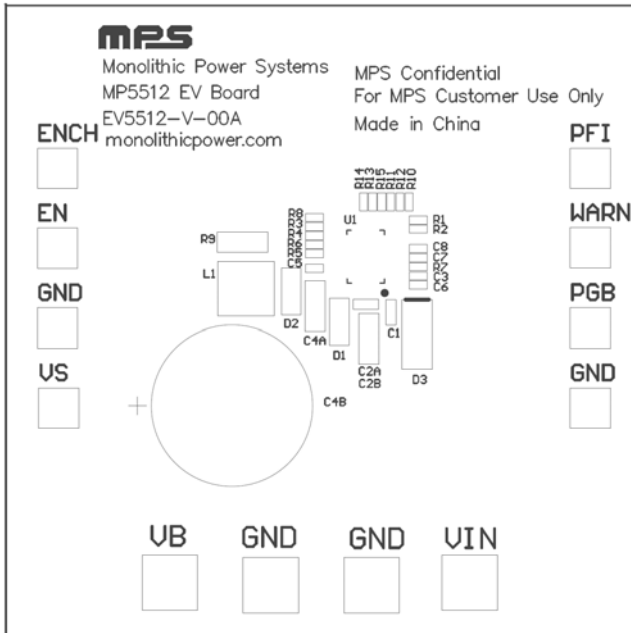

Figure 1—Top Silk Layer

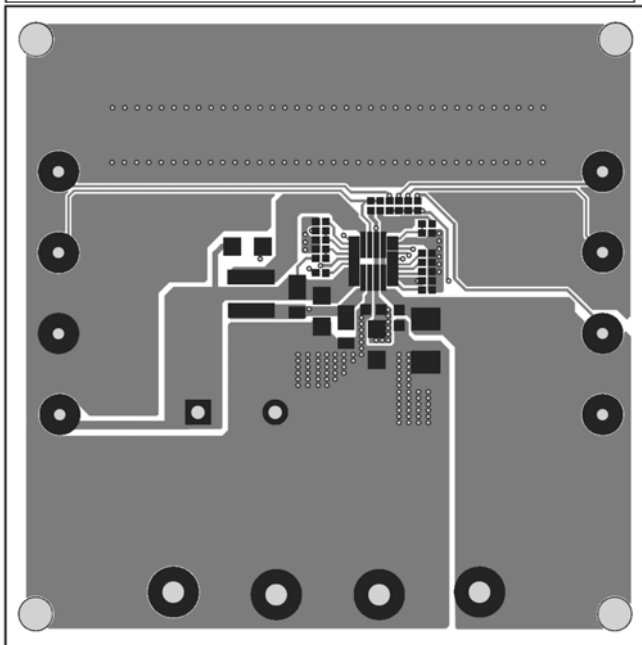

Figure 2—Top Layer

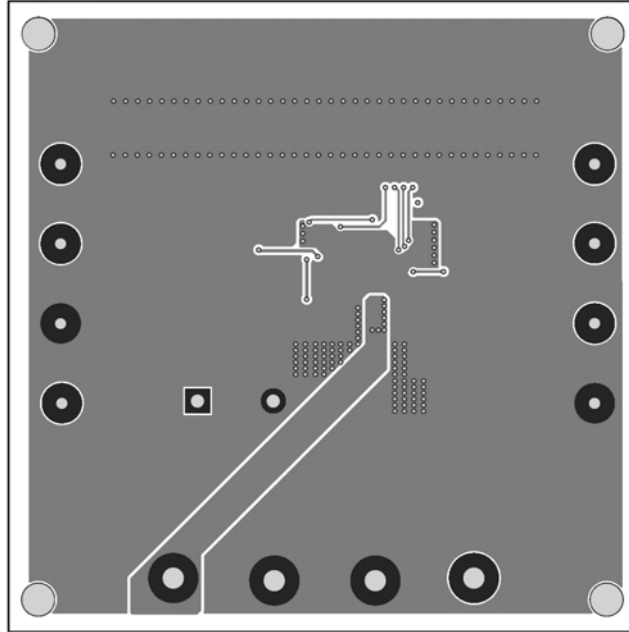

Figure 3—Bottom Layer

QUICK START GUIDE

The board layout accommodates most commonly used components.

- 1, Connect the positive and negative terminals of the load to VB and GND pins, respectively.
- 2, Preset power supply to 12V, then turn off power supply.
- 3, Connect power supply terminals to: VIN and GND on board.
- 4, Turn on power supply after making connections, MP5512 will charge the storage capacitor to 35V.
- 5, In order to observe the power release performance, following two methods can be applied:

Turn off the power supply.

Short VIN to GND. Note: make sure bench power supply have output current limiting when such test.

- 6, To use the enable function, apply a digital input to the EN pin. Drive EN higher than 1.2V to turn on the regulator or less than 0.4V to turn it off.

- 7, Use R1 and R2 to set power fail indicate voltage:

$$V_{PFI} = (0.8V \times 99\%) \frac{R1+R2}{R2}$$

And after power fail, bus voltage VB regulation can be set through R3 and R4:

$$VB_{RLS} = \left(1 + \frac{R3}{R4}\right) \times \left(V_{FBB-REF} + \frac{V_{RAMP}}{2}\right)$$

Where, V_{RAMP} is buck FBB internal compensation ramp voltage, and can be estimated as:

$$V_{RAMP} = V_{STRG} \times D \times (1-D) \times \frac{10^6}{220 \times F_{SW}}$$

Where, $V_{FBS-REF}$ is 0.8V typically. D is the buck duty cycle, and F_{SW} is the switching frequency.

Similarly, R5 and R6 can be chosen for storage voltage setting:

$$V_{STRG} = 0.8V \times \frac{R5+R6}{R6}$$

NOTICE: The information in this document is subject to change without notice. Users should warrant and guarantee that third party Intellectual Property rights are not infringed upon when integrating MPS products into any application. MPS will not assume any legal responsibility for any said applications.