

DESCRIPTION

EV5505A-L-00A Evaluation Board is designed to demonstrate the capabilities of MP5505A. The MP5505A is front end power and data backup power management Unit IC for SSD application. It supports input hot swap, input startup inrush current control, input current limit, power on reset and backup power management for SSD data backup in case of input power failure. MP5505A's built-in boost mode converter charges energy storage bulk capacitor to a programmed voltage level (up to 30V) when system is powered up and keeps refreshing the charge during normal operation. In case of input power failure, MP5505A flags the input power failure, disconnects input power and transfers the energy from energy storage bulk capacitor to SSD system's DCDC switches via built-in buck mode converter to keep SSD system powered for data backup.

The MP5505A requires a minimum number of readily available standard external components and is available in a space QFN20 (3mmX4mm) package.

ELECTRICAL SPECIFICATION

Parameter	Symbol	Value	Units
Input Voltage	V_{IN}	5	V
Charge Voltage	V_{STRG}	12	V
Regulated Bus Voltage at Pfail	V_{RLS}	4.2	V
Boost Mode Inductor Peak Current	I_{CHARGE}	0.4	A
Buck Mode Max Output Current at Pfail	$I_{RELEASE}$	3	A

FEATURES

- Wide 2.7 to 6V Operating Input Range
- 60mΩ Back to Back Switch for Input Current Limit Circuit and Reverse Current Blocking
- Default 4.1A Input Current Limit
- Reverse Current Protection
- 6V Bus Clamping Voltage
- Power on Reset
- Adjustable dv/dt Slew Rate for Bus Voltage Start-up
- Power Good indicators
- Thermal Protection
- Available in an QFN20(3mmx4mm) Package

APPLICATIONS

- Hard Dish Drives
- Solid State Drives

All MPS parts are lead-free, halogen free, and adhere to the RoHS directive. For MPS green status, please visit MPS website under Quality Assurance.

"MPS" and "The Future of Analog IC Technology" are Registered Trademarks of Monolithic Power Systems, Inc.

EV5505A-L-00A EVALUATION BOARD



(L x W) 6.35cm x 6.35cm

Board Number	MPS IC Number
EV5505A-L-00A	MP5505AGL

EVALUATION BOARD SCHEMATIC

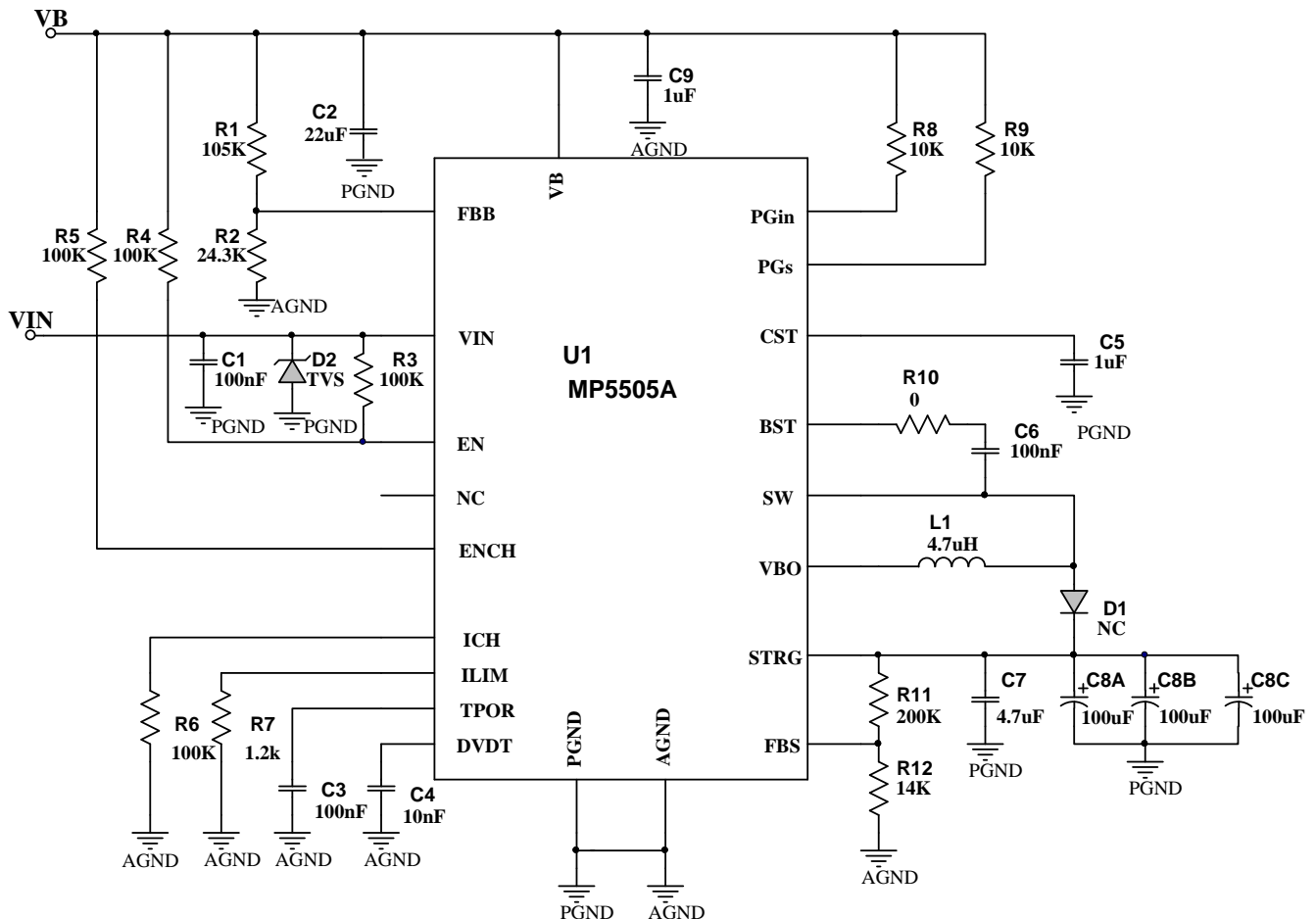

EV5505A-L-00A BILL OF MATERIALS

Qty	Ref	Value	Description	Package	Manufacturer	Manufacturer P/N
1	L1	4.7 μ H	4.7 μ H, DCR 19.5m Ω , Isat 7A	SMD	Würth	744311470
1	R1	105k	Film Res., 1%	0603	Yageo	RC0603FR-07105KL
1	R2	24.3k	Film Res., 1%	0603	Yageo	RC0603FR-0724K3L
4	R3, R4, R5, R6	100k	Film Res., 1%	0603	Yageo	RC0603FR-07100KL
1	R7	1.2k	Film Res., 1%	0603	Yageo	RC0603FR-071K2L
2	R8, R9	10k	Film Res., 1%	0603	Yageo	RC0603FR-0710KL
1	R10	0	Film Res., 1%	0603	Yageo	RC0603FR-070L
1	R11	200k	Film Res., 1%	0603	Yageo	RC0603FR-07200KL
1	R12	14k	Film Res., 1%	0603	Yageo	RC0603FR-0714KL
3	C1, C3, C6	100nF	Ceramic Cap., 25V, X7R	0603	Murata	GRM188R71E104KA01D
1	C2	22 μ F	Ceramic Cap., 10V, X5R	1206	Murata	GRM31CR61A226ME19L
1	C4	10nF	Ceramic Cap., 16V, X7R	0603	Murata	GRM188R71C103KA01D
2	C5, C9	1 μ F	Ceramic Cap, 16V, X7R	0603	Murata	GRM188R71C105KA12D
1	C7	4.7 μ F	Ceramic Cap., 25V, X5R	1206	Murata	C3216X5R1C475K
3	C8A, C8B, C8C	100 μ F	25V/100 μ F	CD284	JH	ECR1EXY101M063011
0	D1	NC				
1	D2	SMA6J5.0A	TVS DIODE	SMA	VISHAY	SMA6J5.0A
1	U1	MP5505A	MP5505AGL	QFN20-3mmx4mm	MPS	MP5505AGL

EVB TEST RESULTS

Performance waveforms are tested on the evaluation board.

$V_{IN} = 5V$, $V_{STORAGE} = 12V$, $V_{RELEASE} = 4.2V$, For DCDC Converter: $P_{OUT} = 5W$, $V_{OUT} = 4.2V$, $L = 4.7\mu H$, $T_A = +25^\circ C$, unless otherwise noted.

V_{STORAGE} Charge

$P_{OUT} = 5W$, $C_{STORAGE} = 300\mu F$

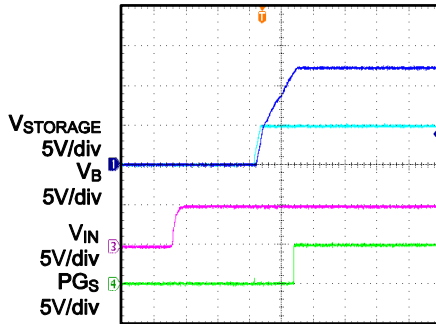

40ms/div

V_{STORAGE} Release

$P_{OUT} = 5W$, $C_{STORAGE} = 300\mu F$

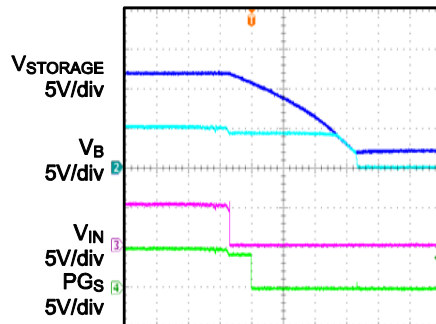

1ms/div

Release Time

$P_{OUT} = 5W$, $C_{STORAGE} = 300\mu F$

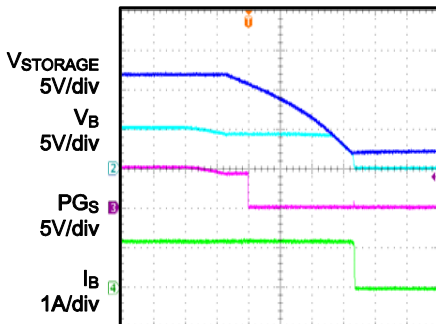

1ms/div

Release Time

$P_{OUT} = 8W$, $C_{STORAGE} = 300\mu F$

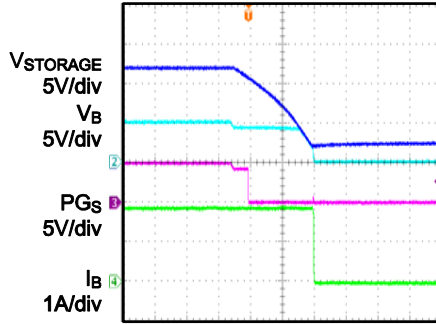

1ms/div

Release Time

$P_{OUT} = 12W$, $C_{STORAGE} = 300\mu F$

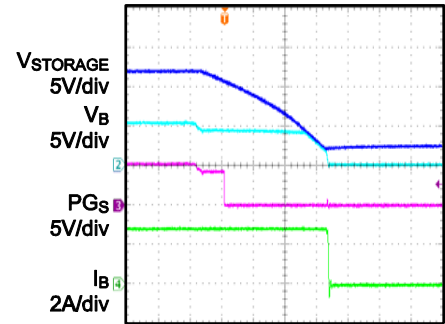

400µs/div

Release Time

$P_b = 5W$, $C_{STORAGE} = 1000\mu F$

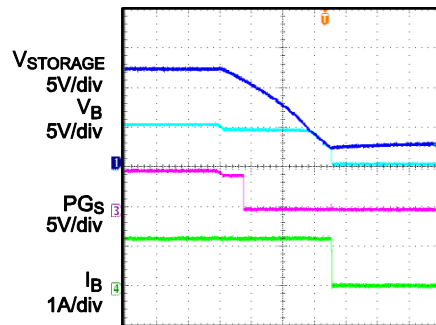

4ms/div

Release Time

$P_b = 5W$, $C_{STORAGE} = 2200\mu F$

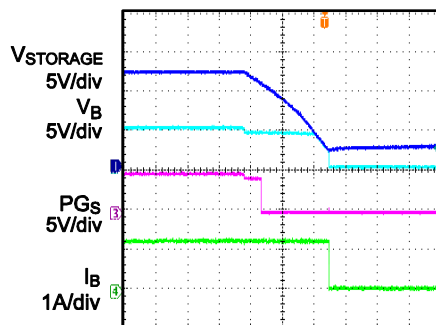

10ms/div

Release Time

$P_b = 5W$, $C_{STORAGE} = 4400\mu F$

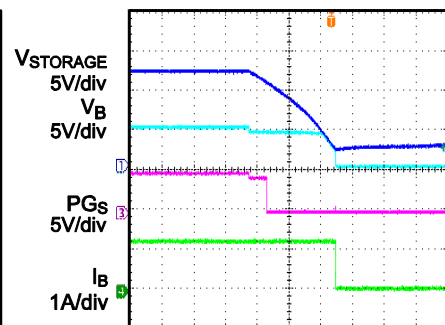

20ms/div

PRINTED CIRCUIT BOARD LAYOUT

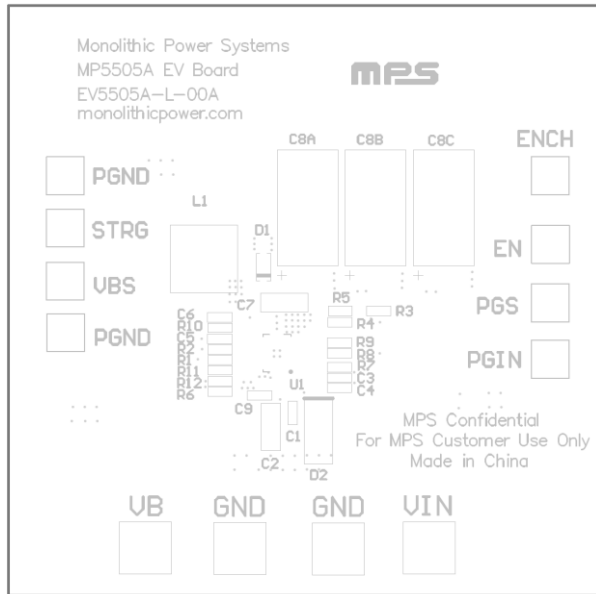

Figure 1—Top Silk Layer

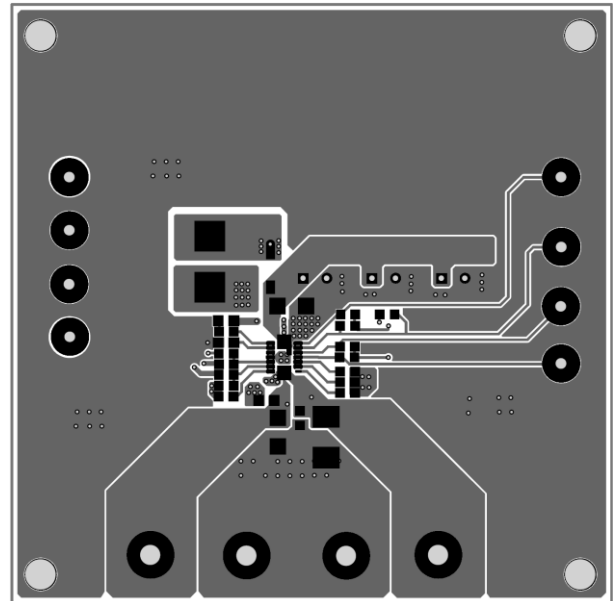

Figure 2—Top Layer

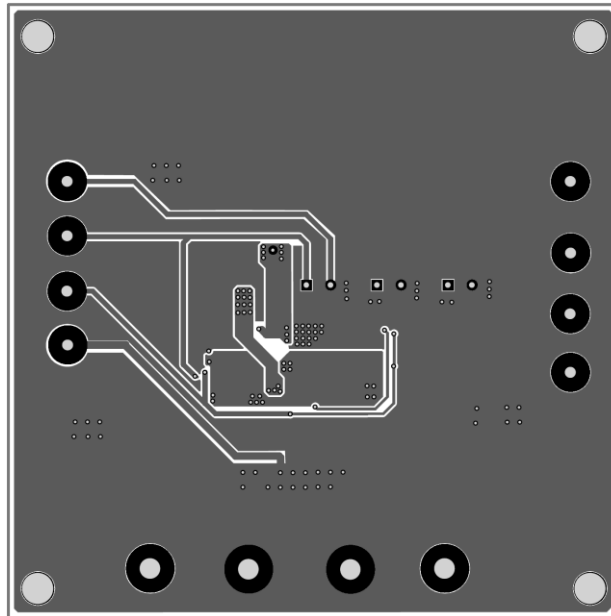

Figure 3—Bottom Layer

QUICK START GUIDE

The board layout accommodates most commonly used components.

1. Connect the positive and negative terminals of the load to VB and GND pins, respectively.
2. Preset Power Supply to 5V. Turn off Power Supply.
3. Connect Power Supply terminals to:
Positive (+): VIN
Negative (-): GND
4. Turn on Power Supply after making connections, MP5505A will charge the storage capacitor to 12V after DCDC converter completes start-up.
5. In order to observe the power release performance, following two methods can be applied:
Turn off the power supply.
Short VIN to GND directly. Note: make sure bench power supply have output current limiting when doing this test.
6. Use R1 and R2 to set release voltage:

$$V_{\text{RELEASE}} = 0.79V \times \frac{R1 + R2}{R2}$$

Similarly, R11 and R12 can be chosen for storage voltage setting:

$$V_{\text{CHARGE}} = 0.79V \times \frac{R11 + R12}{R12}$$

NOTICE: The information in this document is subject to change without notice. Please contact MPS for current specifications. Users should warrant and guarantee that third party Intellectual Property rights are not infringed upon when integrating MPS products into any application. MPS will not assume any legal responsibility for any said applications.