



EV5496-R-00A

5V Power Management IC Evaluation Board

DESCRIPTION

The EV5496-R-00A is an evaluation board for MP5496, a complete power management solution that integrates four high-efficiency, step-down, DC/DC converters, five low-dropout regulators, and a flexible logic interface.

A constant-on-time (COT) control DC/DC converter provides fast transient response. The 1.5MHz default fixed switching frequency during continuous conduction mode (CCM) reduces the external inductor and capacitor values greatly. Full protection features include under-voltage lockout (UVLO), over-current protection (OCP), and thermal shutdown.

The output voltage is adjustable through the I²C bus or pre-set by the one-time programmable (OTP) function. The power on/off sequence is also programmable by the OTP or can be controlled through the I²C bus online.

The MP5496 requires a minimal number of external components and is available in a space-saving, 28-pin QFN (4mmx4mm) package.

FEATURES

- Four High-Efficiency Step-Down Converters
 - Buck1: 4.5ADC/DC Converter
 - Buck2: 2.5A DC/DC Converter
 - Buck3: 4A DC/DC Converter
 - Buck4: 2A DC/DC Converter
 - 0.6V-2.1875V/ 12.5mV step Vout range
 - 2.8V to 5.5V Operating Input Range
 - Adjustable Switching Frequency
 - Programmable Forced PWM, Auto PFM/PWM Mode
 - Hiccup Over-Current Protection (OCP)
- Five Low-Dropout Regulators
 - One RTC Dedicate LDO
 - Four Low Noise LDOs
 - Two Separate Input Power Supplies
 - 100mV Dropout at 300mA Load
- System
 - I²C Bus and OTP
 - Power-On/-Off Button
 - Power-On Reset Output
 - Flexible Power-On/-Off Sequence via OTP
 - Flexible DC/DC, LDO On/Off via OTP
 - ±4kVHBM and ±2kV CDM ESD Rating for All Pins

APPLICATIONS

- Cable Modems, Set-Top Boxes
- Televisions
- MID, Tablets
- POS Machines
- SSD
- IP Cameras

All MPS parts are lead-free, halogen-free, and adhere to the RoHS directive. For MPS green status, please visit the MPS website under Quality Assurance. "MPS" and "The Future of Analog IC Technology" are registered trademarks of Monolithic Power Systems, Inc.

EV5496-R-00A EVALUATION BOARD



(L X W) 9.4CM X 8.6CM

Board Number	MPS IC Number
EV5496-R-00A	MP5496GR-0001

Efficiency vs. Load current

V_{IN}=3.3V, F_{sw}=1.5MHZ, PWM MODE

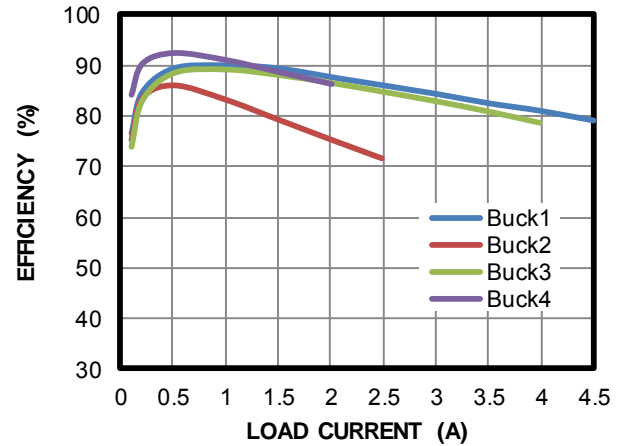

OTP-EFUSE SELECTED TABLE BY DEFAULT

OTP Items	Buck1	Buck2	Buck3	Buck4	LDORTC	LDO2	LDO3	LDO4	LDO5
Output Voltage	1.0V	0.9V	0.9V	1.8V	1.2V	3V	1.8V	1.2V	0.9V
Initial On/Off	On	On	On	On	On	On	Off	On	On
Mode	FPWM	FPWM	FPWM	FPWM	N/A				
Power-On Delay/Time Slot #	0ms/0	4ms/2	2ms/1	6ms/3	Always on	12ms/6	N/A	8ms/4	10ms/5
Automatic Turn-On	Yes								
Switching Frequency	1.5MHz								
Push-Button Timer	2 seconds								
RSTO Delay	100ms								
Buck 1 Peak Current Limit	6.8A								
Buck 3 Peak Current Limit	5.6A								
I ² C Slave Address	0x69								
OTP Version	0004								

Other Parameters Information									
	Buck1	Buck2	Buck3	Buck4	LDORTC	LDO2	LDO3	LDO4	LDO5
I _{out max}	3.6A	1.5A	3.6A	0.3A	0.001A	0.025A	0.015A	0.15A	0.1A
Input voltage_Min.	3V								
Input voltage_Typ.	3.3V								
Input voltage_Max.	3.6V								

EVALUATION BOARD SCHEMATIC

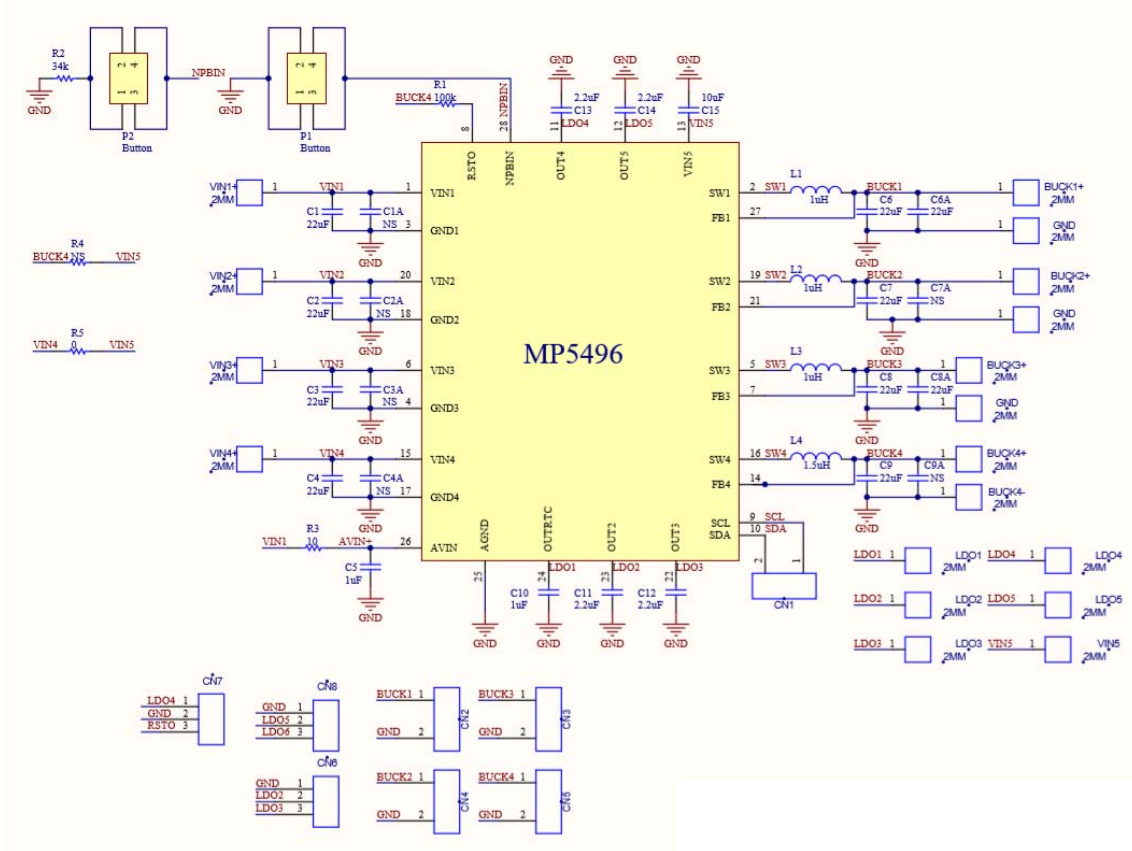

EV5496-R-00A BILL OF MATERIALS

Qty	RefDes	Value	Description	Package	Manufacturer	Manufacturer P/N
6	C6, C6A, C7, C8, C8A, C9	22 μ F	Ceramic Cap,6.3V,X5R	0805	Murata	GRM21BR60J226ME39L
4	C1, C2, C3, C4	22 μ F	Ceramic Cap,10V,X5R	0805	Murata	GRM21BR61A106KE19L
2	C5, C10	1 μ F	Ceramic Cap,10V,X5R	0603	Murata	GRM188R61A105KA61D
5	C11, C12, C13, C14	2.2 μ F	Ceramic Cap,10V,X5R	0603	Murata	GRM188R61A225KE34
1	C15	2.2 μ F	Ceramic Cap,10V,X7R	0805	Murata	GRM21BR71A225KA01L
1	R1	100k	Film Res,1%	0603	ROYAL	RL0603FR-07100KL
1	R2	34k	Film Res,1%	0603	ROYAL	RL0603FR-0734KL
1	R3	10 Ω	Film Res,1%	0603	ROYAL	RL0603FR-0710RL
1	R4	NS				
1	R5	0 Ω	Film Res,1%	1206	Yageo	RL1206FR-070RL
3	L1, L2, L3	1 μ H	Inductor, DCR=4.6m Ω , Is=19A	SMD	Würth	744311100
1	L4	1.5 μ H	Inductor, DCR=6.6m Ω , Is=14A	SMD	Würth	744311150
2	P1, P2		Tact Switch	SMD	Würth	430181038816
1	U1	MP5496	5V Power Management IC	QFN28 (4*4)	MPS	MP5496GR-0000

EVB TEST RESULTS

Performance waveforms are tested on the evaluation board.

V_{IN} = 3.3V, T_A = 25°C, test using MP5496-0001 spec parts, unless otherwise noted.

Efficiency vs. Load current

V_{IN}=3.3V, F_{sw}=1.5MHZ, PWM MODE

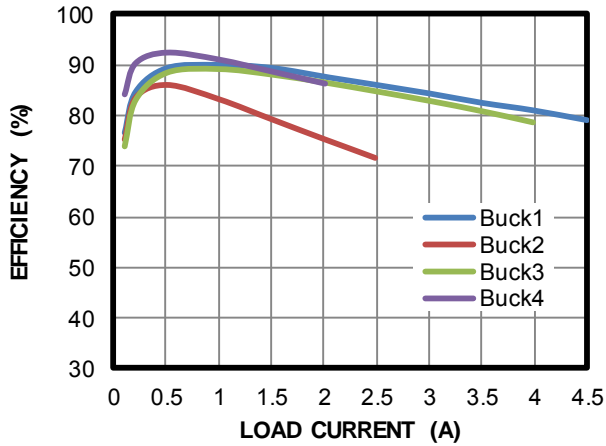

Load regulation vs. Load current

V_{IN}=3.3V, F_{sw}=1.5MHZ, PWM MODE

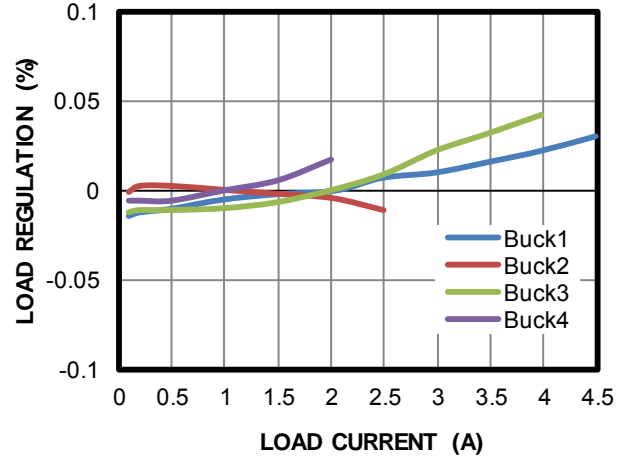

EVB TEST RESULTS *(continued)*

Performance waveforms are tested on the evaluation board.

V_{IN} = 3.3V, T_A = 25°C, test using MP5496-0001 spec parts, unless otherwise noted.

Steady State

V_{IN}=3.3V. Each channel Buck with no load

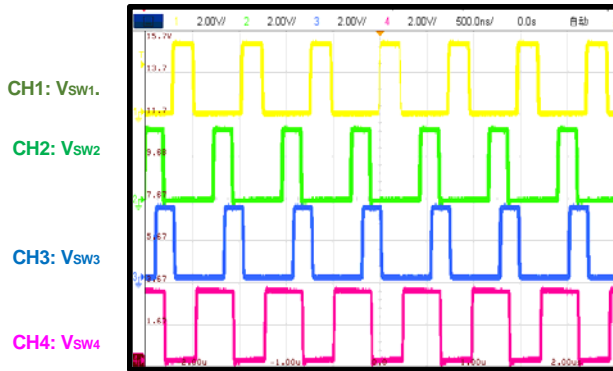

Steady State

V_{IN}=3.3V. Each channel Buck with full load

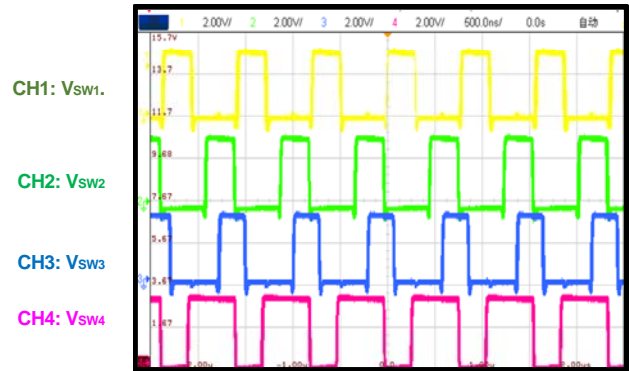

Power On

V_{IN}=3.3V, I_{Buck1}=0A

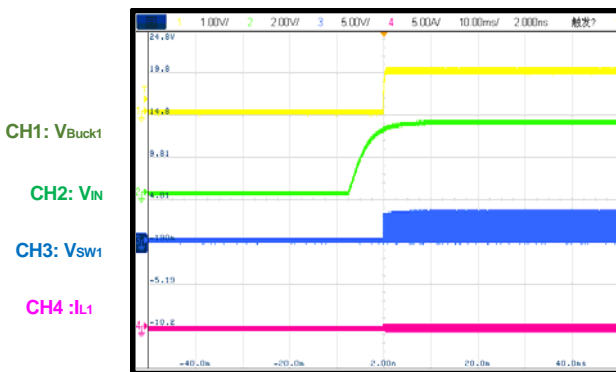

Power On

V_{IN}=3.3V, I_{Buck1}=4.5A

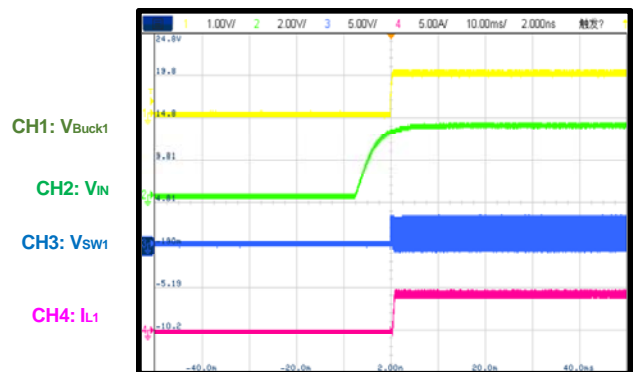

Power Off

V_{IN}=3.3V, I_{Buck1}=0A

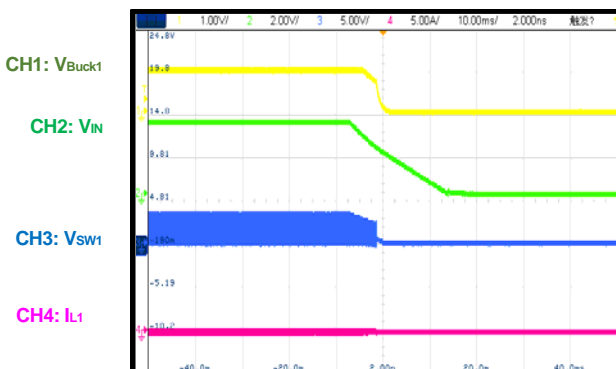

Power Off

V_{IN}=3.3V, I_{Buck1}=4.5A

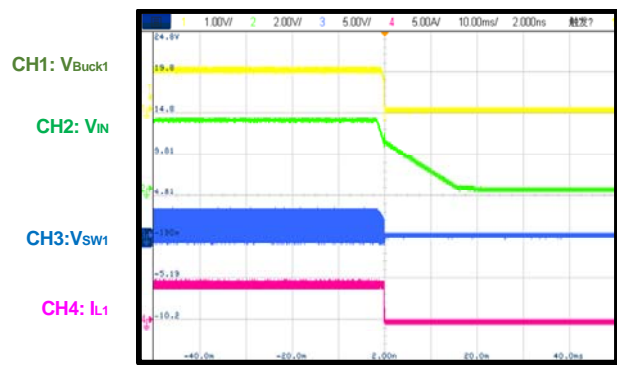

EVB TEST RESULTS (continued)

Performance waveforms are tested on the evaluation board.

VIN = 3.3V, TA = 25°C, test using MP5496-0001 spec parts, unless otherwise noted.

Load transient

IOUT=0-4.5A, 2.5A/μs

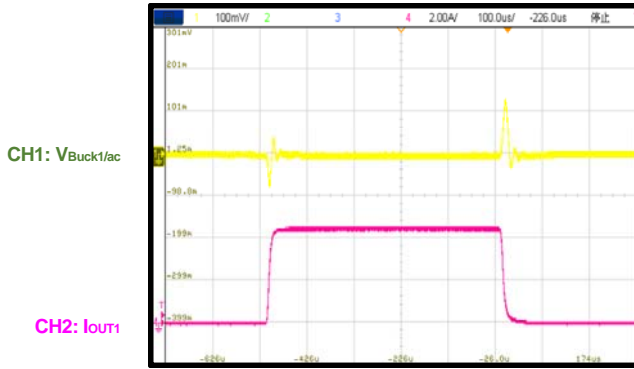

Load transient

IOUT=0-2A, 2.5A/μs

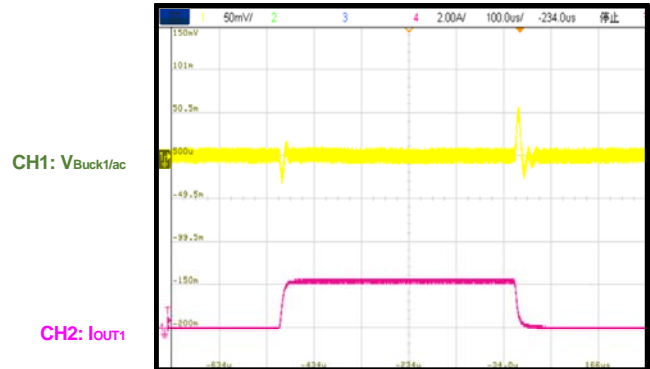

Load transient

IOUT=2A-4.5A, 2.5A/μs

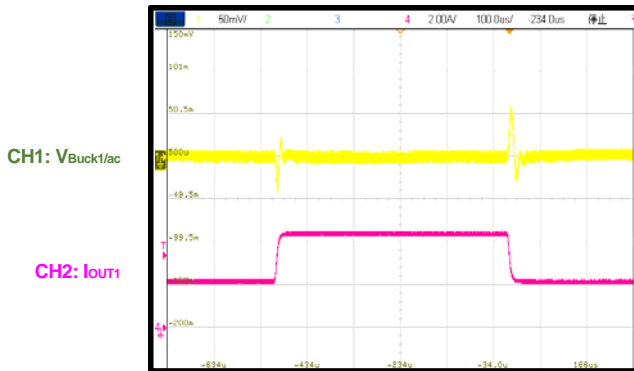

nPBIN Power on

Each channel with no load

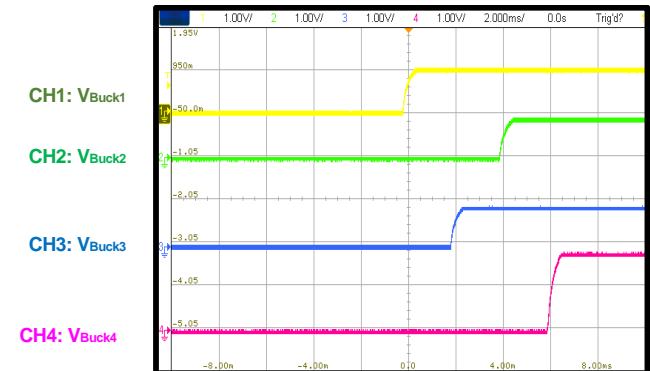

nPBIN Power on

Each channel with no load

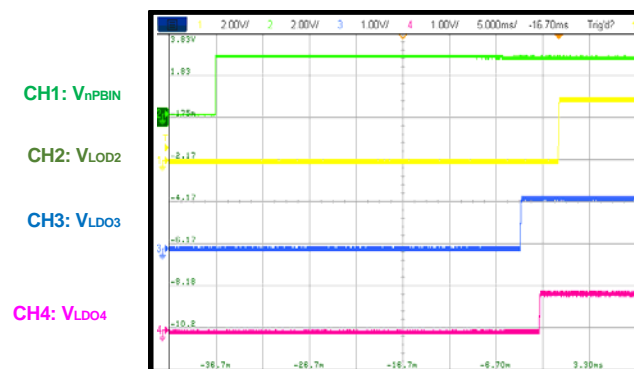

nPBIN Power off

Each channel with no load

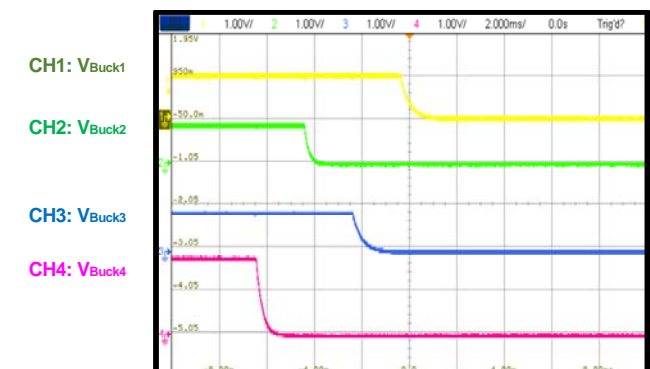

EVB TEST RESULTS *(continued)*

Performance waveforms are tested on the evaluation board.

VIN = 3.3V, TA = 25°C, test using MP5496-0001 spec parts, unless otherwise noted.

nPBIN Power off
Each channel with no load

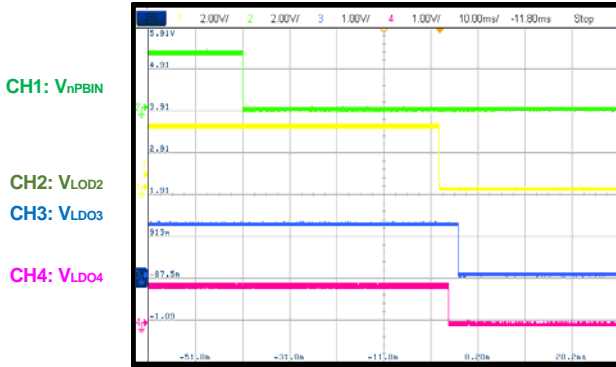

SCP Entry and Recovery
SCP Entry, no load.

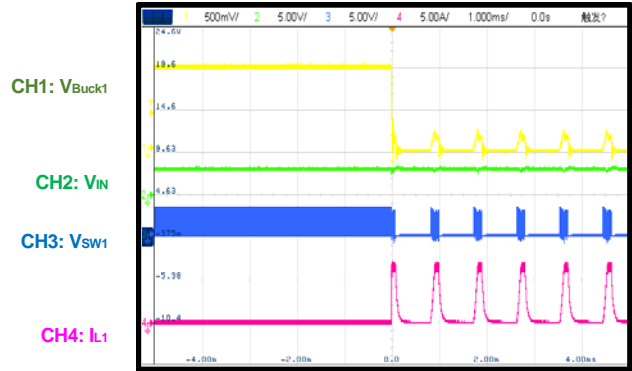

SCP Entry and Recovery
SCP Steady State, no load.

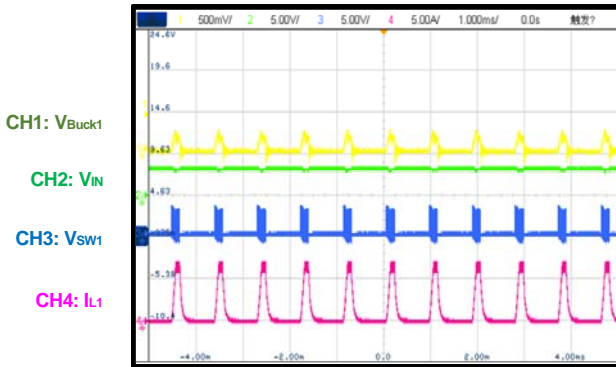

SCP Entry and Recovery
SCP Recovery, no load.

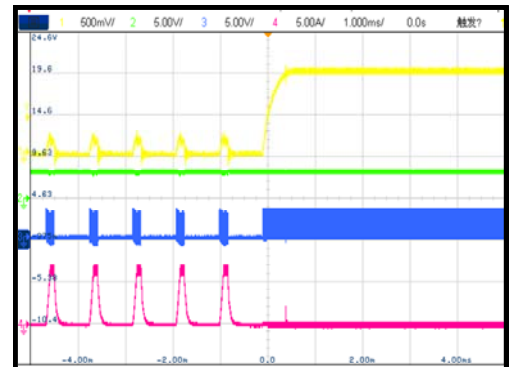

SCP Entry, full load.
SCP Entry, full load.

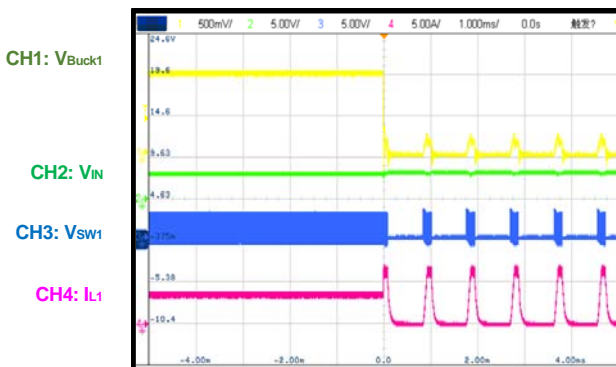

SCP Entry, full load.
SCP Steady State, full load.

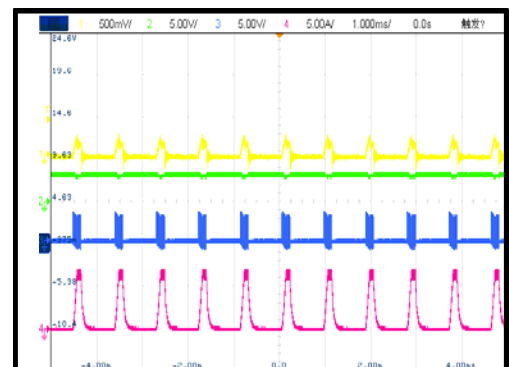

EVB TEST RESULTS *(continued)*

Performance waveforms are tested on the evaluation board.

VIN = 3.3V, TA = 25°C, test using MP5496-0001 spec parts, unless otherwise noted.

SCP Entry, full load.

SCP Recovery, full load.

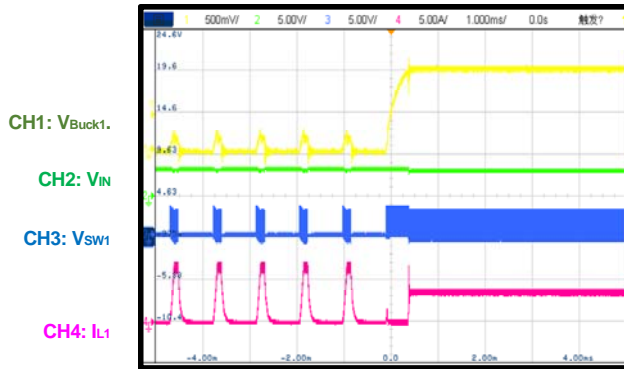

PRINTED CIRCUIT BOARD LAYOUT

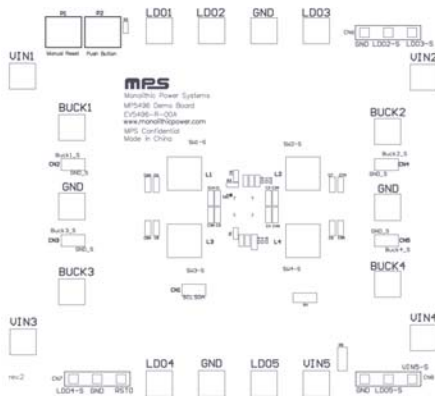

Figure 1: Top Silk Layer

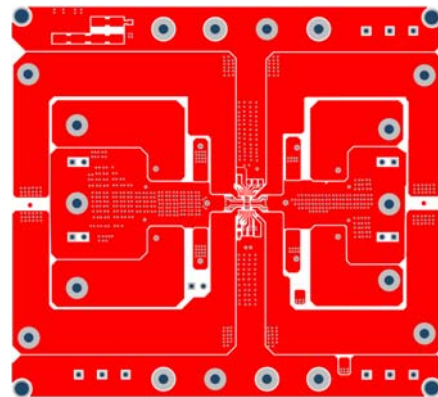

Figure 2: Top Layer

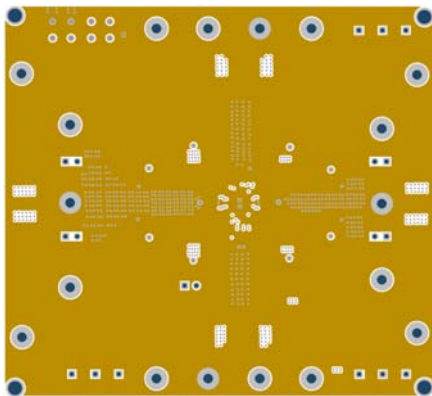

Figure 3: Middle Layer 1

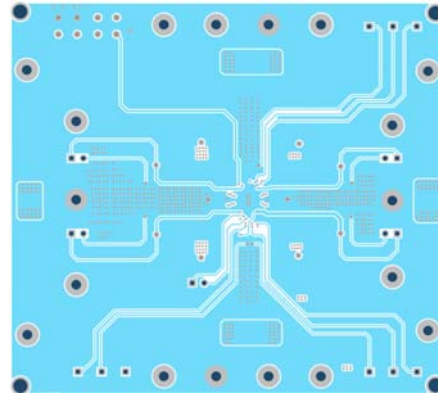

Figure 4: Middle Layer 2

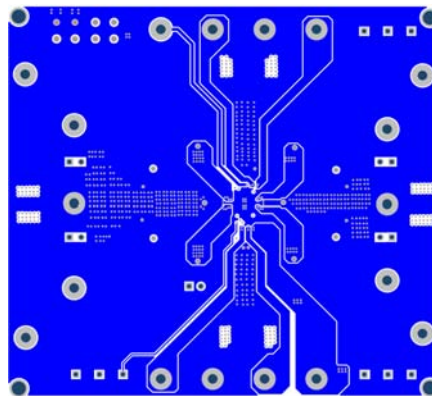

Figure 5: Bottom Layer

QUICK START GUIDE

1. Connect the positive and negative terminals of the load to the VOUT and GND pins, respectively.
2. Preset the power supply output between 3.0V and 3.6V, and then turn off the power supply.
3. Connect the positive and negative terminals of the power supply output to the VIN and GND pins, respectively.
4. Turn the power supply on. The PMIC will automatically entry power on sequence.

Notes:

- 1) VOUT power terminals on EVB are including buck1-4; LDO1 to LDO5.
- 2) VIN1-4 terminals are shorten-circuit internally. Connect input DC voltage source to either of them is ok.

NOTICE: The information in this document is subject to change without notice. Please contact MPS for current specifications. Users should warrant and guarantee that third party Intellectual Property rights are not infringed upon when integrating MPS products into any application. MPS will not assume any legal responsibility for any said applications.