

DESCRIPTION

The EV5470-L-00A is an evaluation board for MP5470, a complete power management solution which integrates four high efficiency step-down DC/DC converters and flexible logic interface.

COT control DC/DC converter provides fast transient response. Up to 1.6MHz programmable switching frequency greatly reduces external inductor and capacitor size.

Full protection features include UVLO, OCP and thermal shut down.

Output voltage is adjustable through I2C bus or preset by 3 times programmable MTP (Multi Time Programmable) eFuse. The power on/off sequence is also programmable by MTP.

The MP5470 requires a minimal number external components, and is available in space saving 22-pin QFN (3x4mm) package.

FEATURES

- **High Efficiency Step-Down Converters**
 - Quad 2A Buck Converters
 - 3A/3A/1A/1A or 3A/2A/2A/1A from Channel1-Channel4*
 - Out of Phase Synchronization
 - Support I²C Voltage Scaling
 - 6.5V to 16V Operating Input Range
 - Low Rds(on) and High Efficiency
 - Integrated Bootstrap Capacitor
 - 500kHz to 1.6MHz Switching Frequency
 - 500kHz to 1.6MHz Frequency SYNC Input on EN pin
 - I2C Slave Address Programmable
 - 1 GPIO pin which can be configured as "ADD", "PG", "Output Port" or "SYNCO".
 - Power Save Mode or Forced CCM Mode
 - CH1&CH2 can Program to Parallel Mode by MTP
 - CH3&CH4 can Program to Parallel Mode by MTP
 - MTP Programmable Soft-start and Delay
 - MTP Selectable Shutdown Delay
 - MTP&I2C Programmable Current Limit
 - Hiccup Over Current Protection
- **System**
 - I2C Slave and 3 times Programmable MTP
 - Flexible Power On/off Sequence via MTP
 - EN pin

*The maximum current is 3A/3A/2A/2A for Buck1-Buck4. But it's also limited by the maximum junction temperature (<125degC).

APPLICATIONS

- SSD
- Cable Modem
- xDSL
- Set-Top-Box

All MPS parts are lead-free and adhere to the RoHS directive. For MPS green status, please visit MPS website under Products, Quality Assurance page.

"MPS" and "The Future of Analog IC Technology" are registered trademarks of Monolithic Power Systems, Inc.

EV5470-L-00A EVALUATION BOARD

(L X W) 6.35CM X 6.35CM

Board Number	MPS IC Number
EV5470-L-00A	MP5470GL-0000

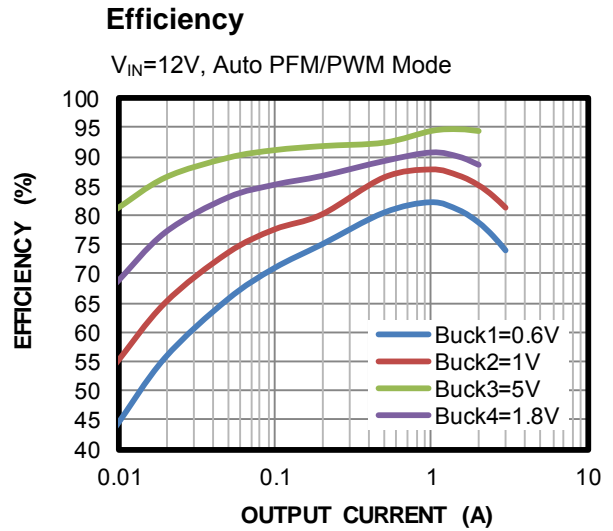
MTP-EFUSE SELECTED TABLE BY DEFAULT*

MTP Items	Buck1	Buck2	Buck3	Buck4
Output Voltage	0.78V	0.78V	1.8V	3.3V
Initial On/off	ON	ON	ON	ON
MODE	PFM	PFM	PFM	PFM
Soft Start Delay/Time Slot #	2ms/2	2ms/2	2ms/2	2ms/2
Soft Start Slew rate	0.25mV/ μ s	0.167mV/ μ s	0.4mV/ μ s	0.501mV/ μ s
Valley Current Limit	4.2A	4.2A	3A	3A
Initial Phase Delay	0°	90°	180°	270°
Additional Phase Delay	0ns	0ns	0ns	0ns
Buck Output Discharge EN	Enabled	Enabled	Enabled	Enabled
Buck Output Limit EN	Enabled	Enabled	Enabled	Disabled
Buck Parallel Mode Operation	Unparalleled		Unparalleled	
Switching Frequency	800kHz			
PG Delay Time	0.2ms			
Software initially I2C Slave Address	0x68			
MTP Configure Code	0x00			
MTP Revision Number	0x00			

*For more detail MTP specification, refer to MP5470 datasheet.

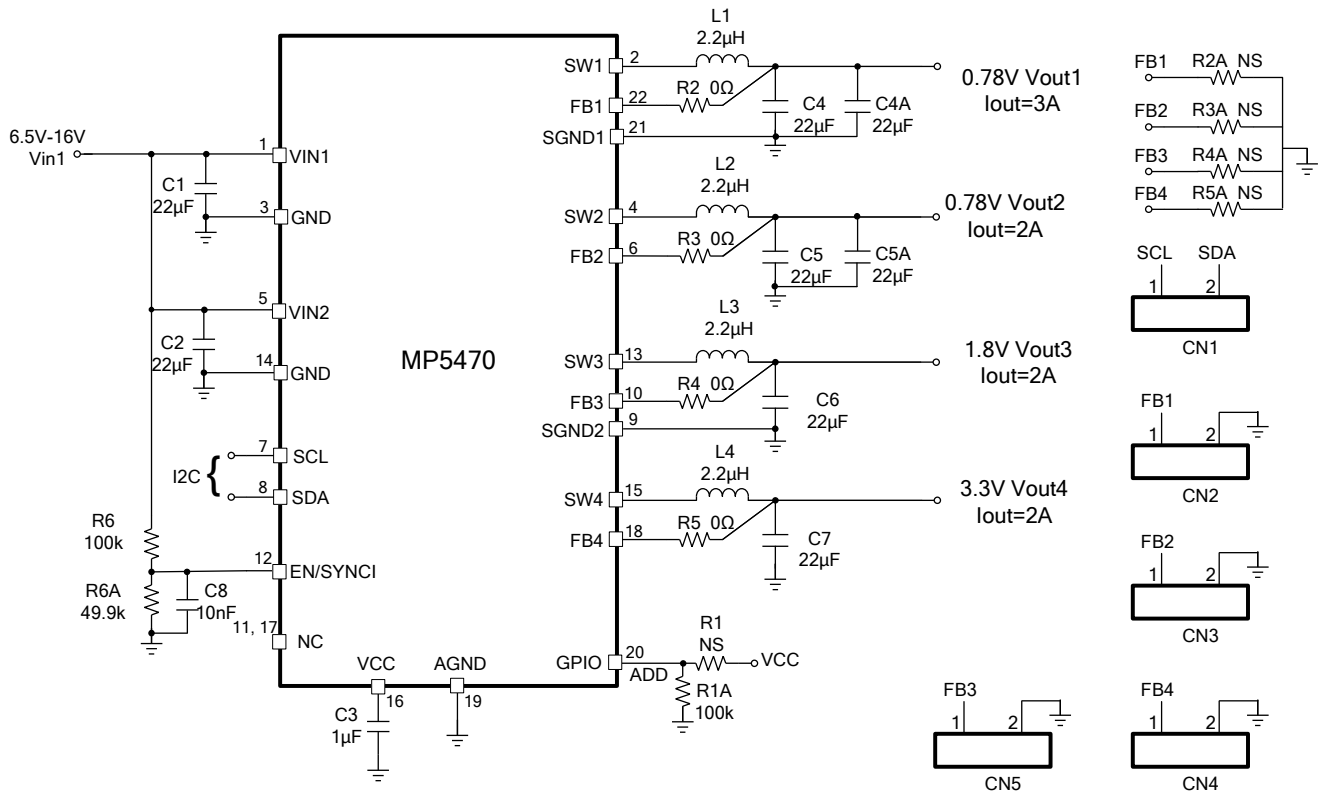
EVALUATION BOARD SCHEMATIC

EV5470-L-00A BILL OF MATERIALS

Qty	RefDes	Value	Description	Package	Manufacturer	Manufacturer P/N
2	C1,C2	22µF	Ceramic Cap,25V,X5R	0805	muRata	GRM21BR61E226ME44L
1	C3	1µF	Ceramic Cap,10V,X5R	0603	muRata	GRM188R61A105KA61D
6	C4, C4A, C5, C5A, C6, C7	22µF	Ceramic Cap,10V,X5R	0805	muRata	GRM21BR61A106KE19L
1	C8	10nF	Ceramic Cap,16V,X7R	0603	muRata	GRM188R71C103KA01D
1	R1A	100k	Film Res. 1%	0603	ROYAL	RL0603FR-07100KL
4	R2, R3, R4,R5,	0Ω	Film Res,1%	0603	ROYAL	RL0603FR-070RL
1	R6	150k	Film Res. 1%	0603	ROYAL	RL0603FR-07150KL
1	R6A	49.9k	Film Res. 1%	0603	ROYAL	RL0603FR-0749K9L
4	L1, L2, L3, L4	2.2µH	Inductor	SMD	Würth	744311220
1	U1		12V Power Management IC	QFN22 (3*4)	MPS	MP5470GL-0000

EVB TEST RESULTS

Performance waveforms are tested on the evaluation board.

VIN1=VIN2=12V, T_A=25°C, Buck1 to Buck4 output 0.78V/0.78V/1.8V/3.3V.

Steady state
Each Channel Buck with Half Load

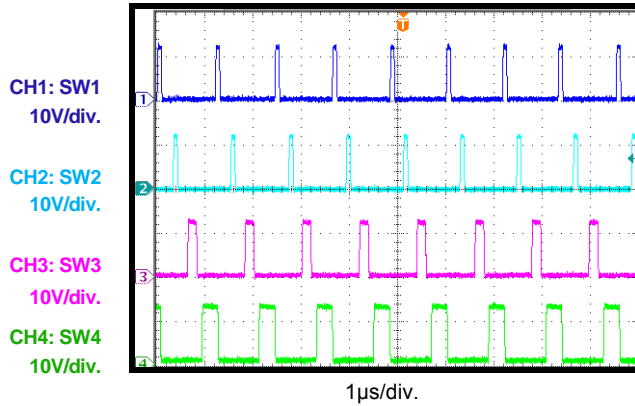

Steady state
Each Channel Buck with Full Load

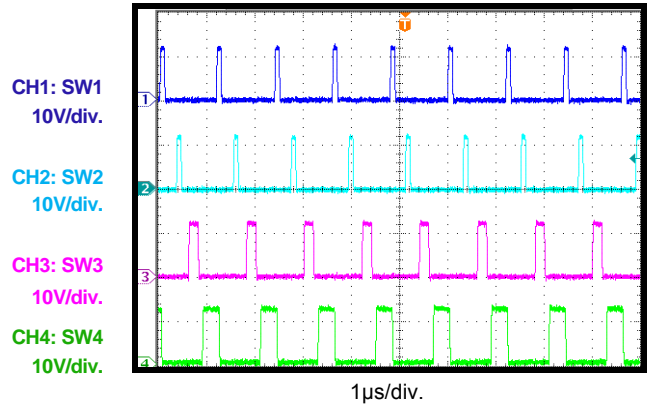

EN Power On
Each Channel Buck without Load

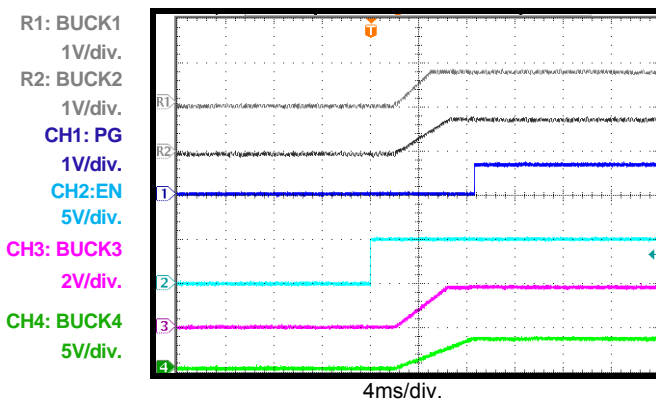

EN Power Off
Each Channel Buck without Load

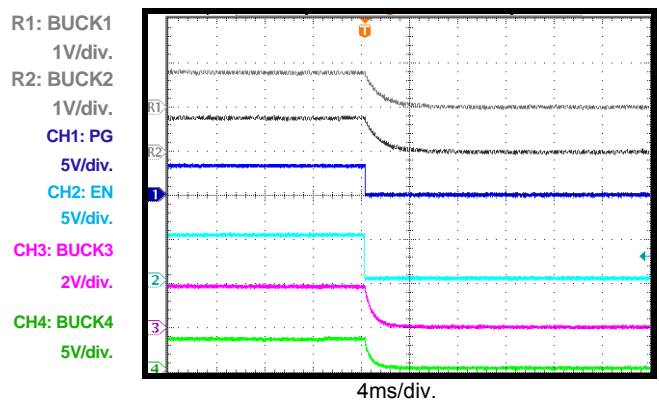

Load Transient Response
Buck1, I_{out} transient from 1.5A to 3A, Slew rate=0.8A/µs

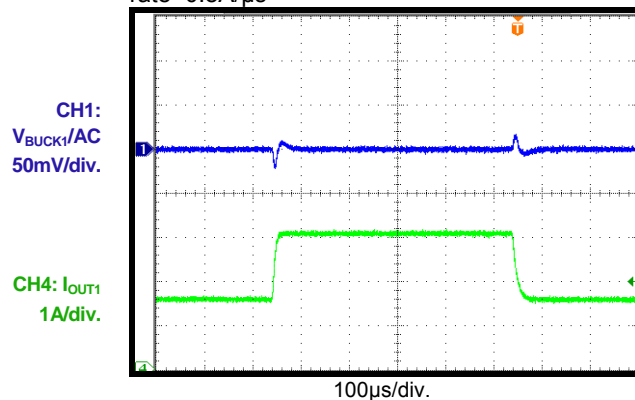

Load Transient Response
Buck2, I_{out} transient from 1.5A to 3A, Slew rate=0.8A/µs

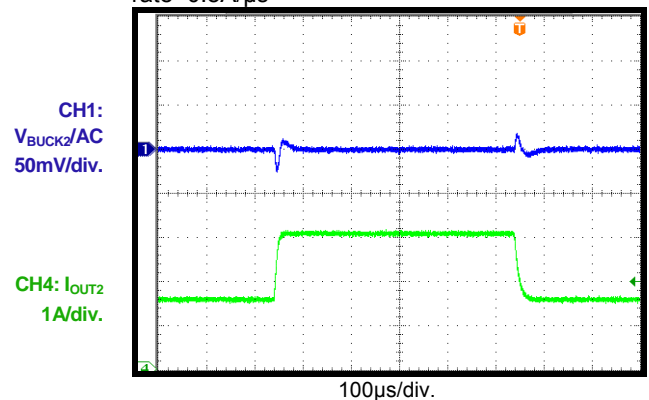

EVB TEST RESULTS *(continued)*

Performance waveforms are tested on the evaluation board.

VIN1=VIN2=12V, T_A = 25°C, Buck1 to Buck4 output 0.78V/0.78V/1.8V/3.3V.

Load Transient Response

Buck3, I_{OUT3} transient from 1A to 2A, Slew rate=0.8A/μs

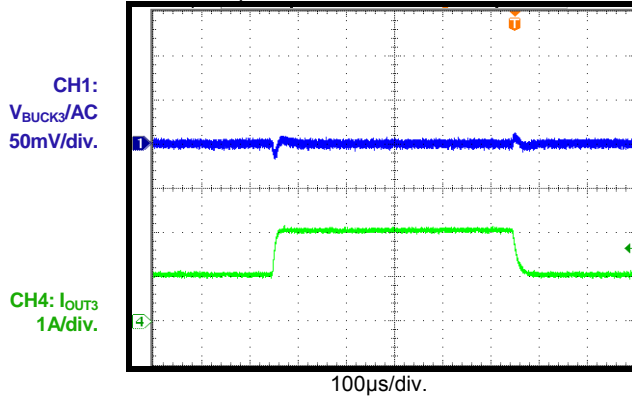

Load Transient Response

Buck4, I_{OUT4} transient from 1A to 2A, Slew rate=0.8A/μs

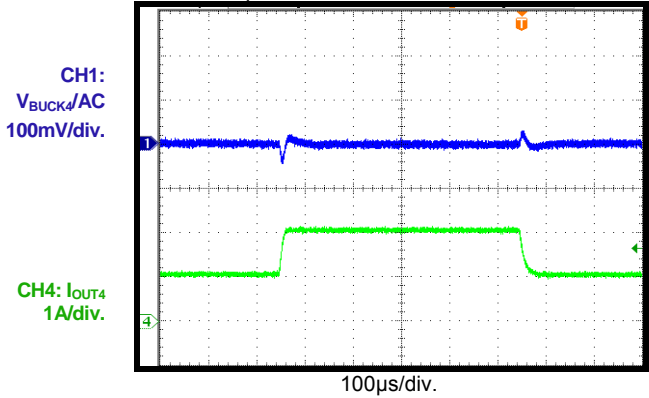

SCP Entry

Buck4 output 3.3V, I_O=0A

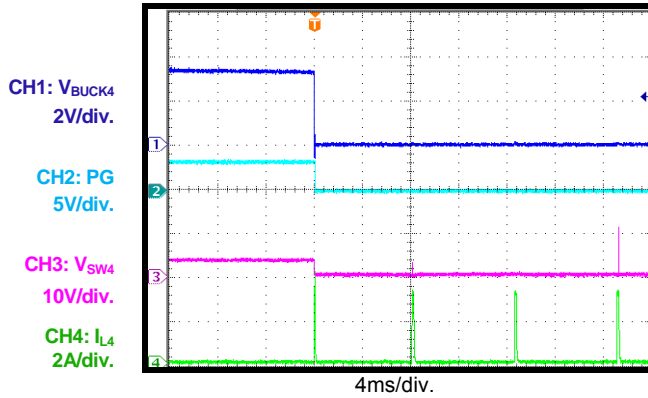

SCP Steady State

Buck4 output 3.3V, I_O=0A

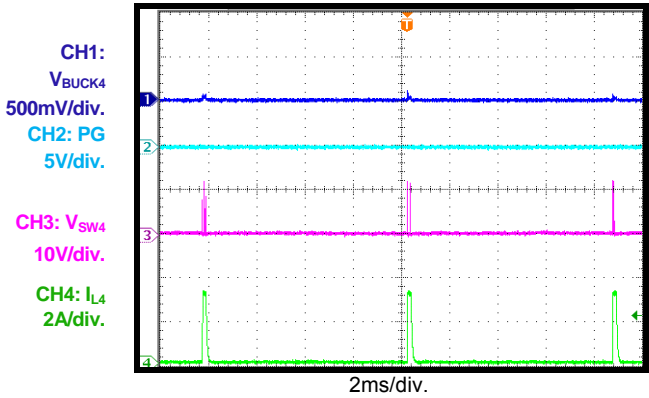

SCP Recovery

Buck4 output 3.3V, I_O=0A

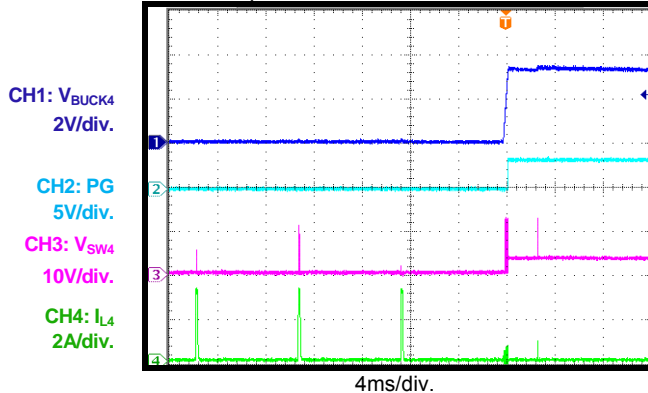

PRINTED CIRCUIT BOARD LAYOUT

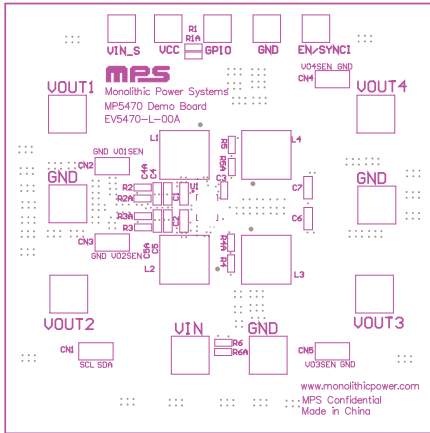

Figure 1—Top Silk Layer

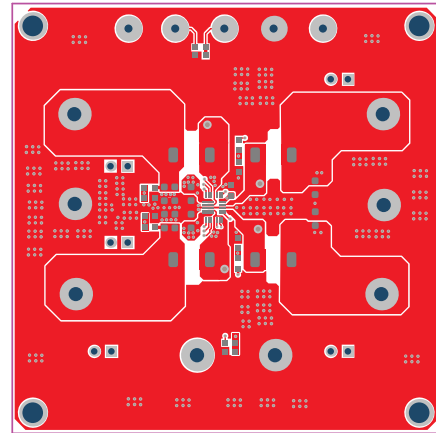

Figure 2—Top Layer

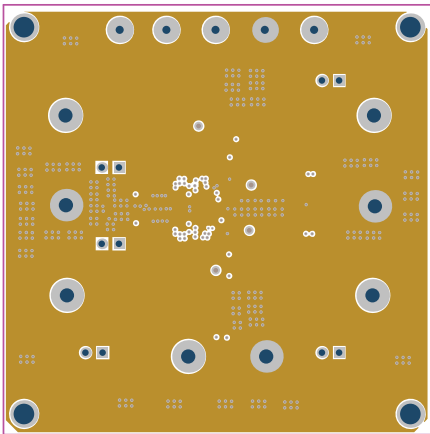

Figure 3—Inner1 Layer

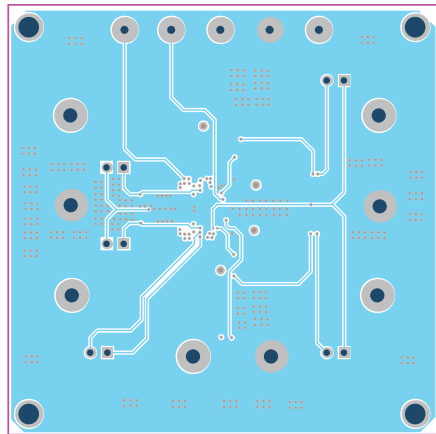

Figure 4—inner2 Layer

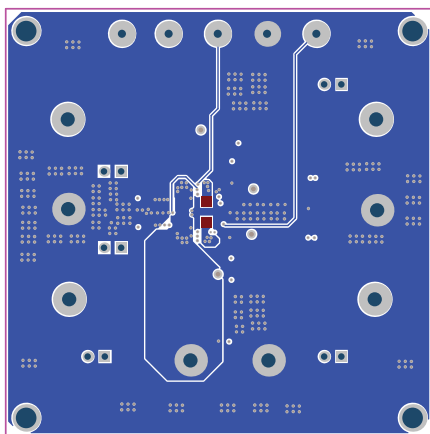

Figure 5—Bottom Layer

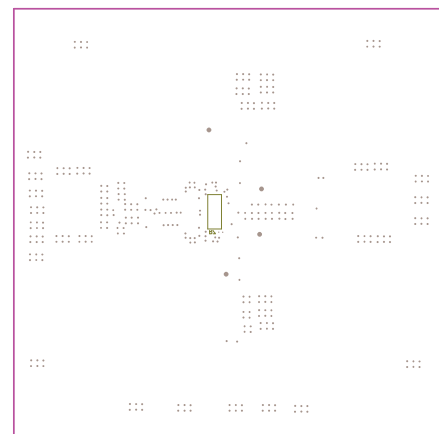

Figure 6—Bottom Silk Layer

QUICK START GUIDE

1. Preset Power Supply between 6.5V and 12V.
2. Turn Power Supply off.
3. Connect Power Supply terminals to:
 - a. Positive (+): VIN
 - b. Negative (-): GND
4. Connect Load to:
 - Load1:
 - a. Positive (+): Vout1
 - b. Negative (-): GND
 - Load2:
 - a. Positive (+): Vout2
 - b. Negative (-): GND
 - Load3:
 - a. Positive (+): Vout3
 - b. Negative (-): GND
 - Load4:
 - a. Positive (+): Vout4
 - b. Negative (-): GND
5. Turn Power Supply on after making connections. The board will automatically start up.
6. To use the Enable function, apply a digital input to the EN/SYNC pin. Drive EN higher than 1.25V to turn on the regulator, or less than 1.02V to turn it off.
7. To use the external synchronous function to adjust the switching frequency, apply an external clock signal to EN/SYNC pin. The MP5470 default switching frequency should be set close to the SYNC input's frequency. For example, when external SYNCI clock is 500kHz, then internal switching frequency should be set as 533kHz via I2C or MTP.

NOTICE: The information in this document is subject to change without notice. Please contact MPS for current specifications. Users should warrant and guarantee that third party Intellectual Property rights are not infringed upon when integrating MPS products into any application. MPS will not assume any legal responsibility for any said applications.