

DESCRIPTION

The MP5092 integrated dual load switches to provide load protection covering 0.5V to 5.5V voltage range. Any one channel can work alone. Each channel can provide 7.5A load capability. With the small R_{DS(on)} in tiny package, MP5092 provides very high efficient and space saving solution in notebook and tablet or other portable devices applications.

With the soft start function, the MP5092 can avoid inrush current during circuit start up. MP5092 also provides different functions, like programmable soft start time, output discharge function, OCP and thermal shutdown features.

The maximum load at the output (source) is current limited. This is accomplished by utilizing a sense FET topology. The magnitude of the current limit is controlled by an external resistor from ILIM pin to ground.

Tiny 18 pins QFN 2mmx3mm of MP5092 is available in space saving package.

ELECTRICAL SPECIFICATION

Parameter	Symbol	Value	Units
Input Voltage	V _{IN1/2}	0.5–5.5	V
Input VCC Voltage	V _{CC1/2}	3–5.5	V
Output Voltage	V _{OUT1/2}	0.5–5.5	V
Output Current	I _{OUT1/2}	7.5	A

FEATURES

- Integrated 10mΩ Low RDSON FETs
- Adjustable Start Up Slew Rate
- Wide VIN Range from 0.5V to 5.5V
- <1μA Shutdown Current
- Programmable 7.5A Current Limit Range
- Output Discharge Function
- Enable Pin
- <200ns Short-Circuit Response Protection
- Thermal Protection
- Small QFN18 2mmx3mm Package for Space Saving

APPLICATIONS

- Notebook and Tablet Computers
- Portable Devices
- Solid State Drivers
- Handheld Devices

All MPS parts are lead-free and adhere to the RoHS directive. For MPS green status, please visit MPS website under Products, Quality Assurance page. "MPS" and "The Future of Analog IC Technology" are registered trademarks of Monolithic Power Systems, Inc.

EV5092-D-00A EVALUATION BOARD



Board Number	MPS IC Number
EV5092-D-00A	MP5092GD

EVALUATION BOARD SCHEMATIC

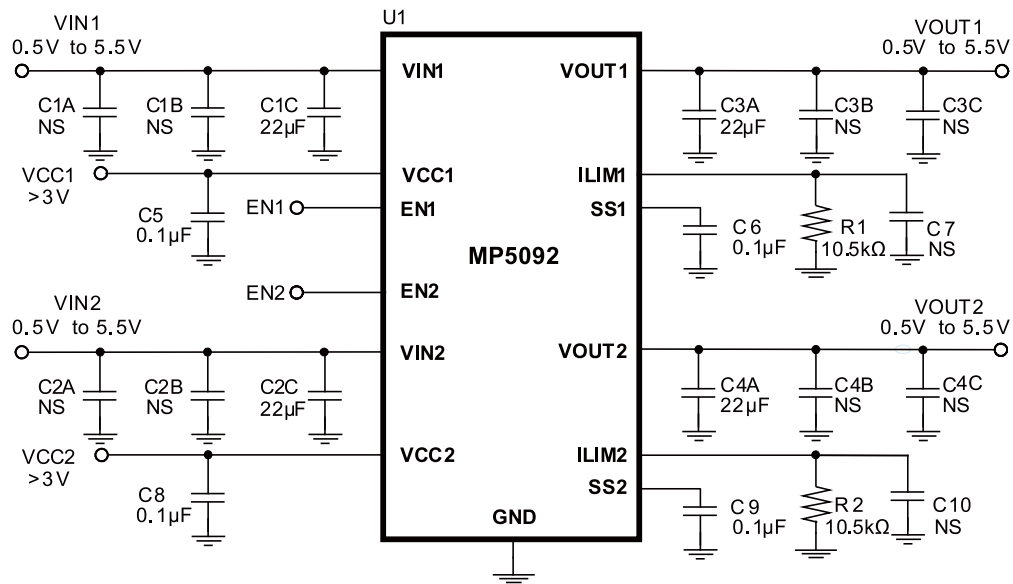

EV5092-D-00A BILL OF MATERIALS

Qty	RefDes	Value	Description	Package	Manufacturer	Manufacturer P/N
0	C1A, C1B C2A, C2B C3B, C3C C4B, C4C	NS		1206		
4	C1C, C3A C2C, C4A	22 μ F	Ceramic Cap, 10V, X5R	1206	muRata	GRM31CR61A226ME19L
0	C7, C10	NS		0603		
4	C5, C6 C8, C9	0.1 μ F	Ceramic Cap, 16V, X7R	0603	muRata	GRM188R71C104KA01D
2	R1, R2	10.5k Ω	Film Res, 1%	0603	ROYAL	RL0603FR-0710K5L
1	U1		7.5A Load Switch	QFN18 2mmx3mm	MPS	MP5092GD

EVB TEST RESULTS

Performance waveforms are tested on the evaluation board.

$V_{IN} = 3.6V$, $V_{CC} = 3.6V$, $R_{LIM} = 10.5k\Omega$, $T_A = 25^\circ C$, unless otherwise noted.

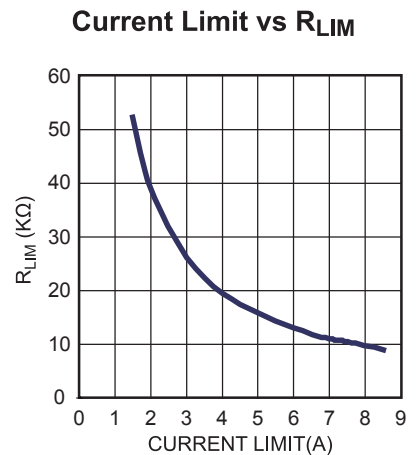
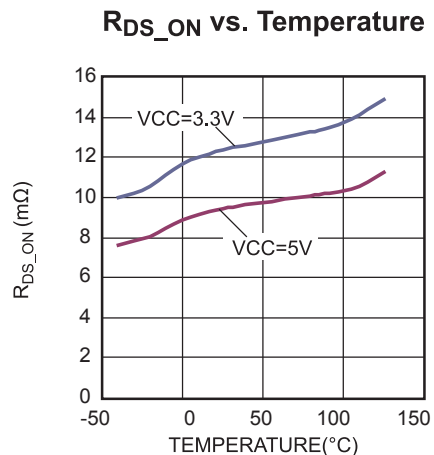
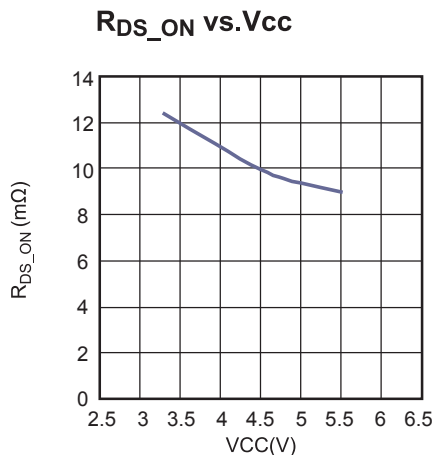
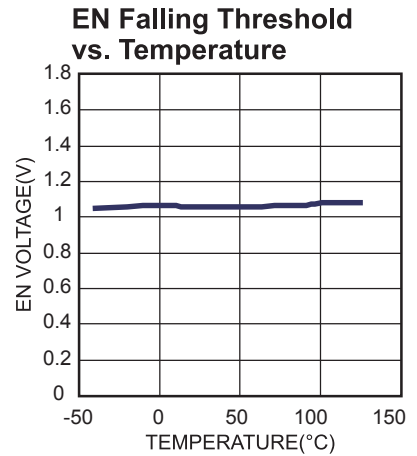
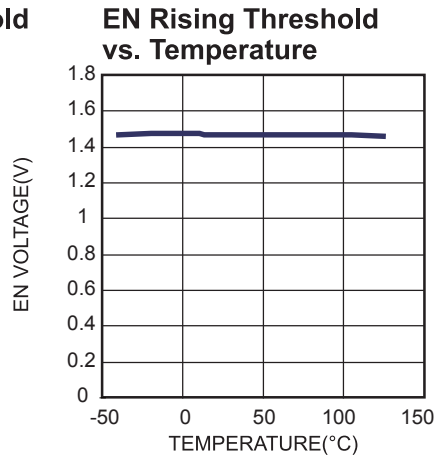
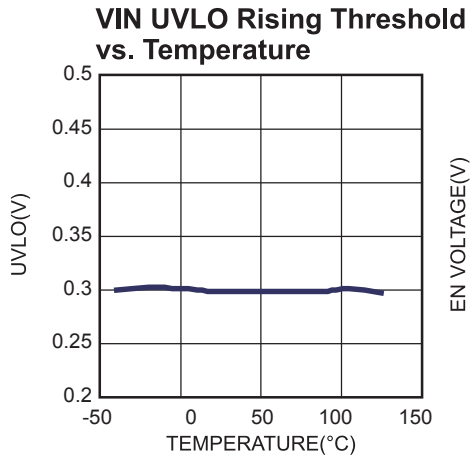
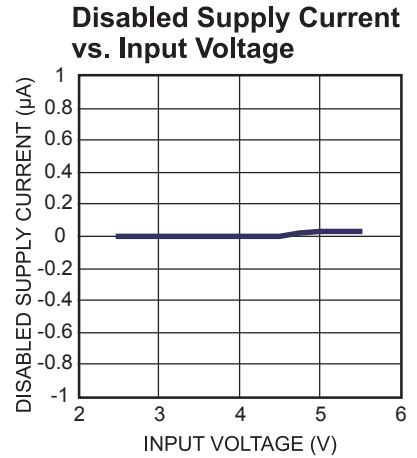
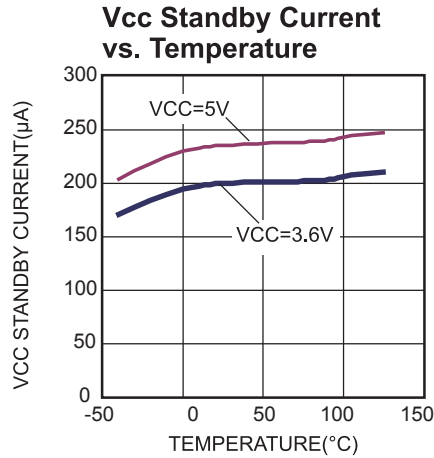
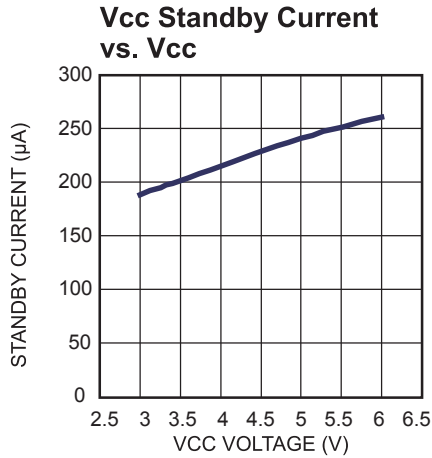

EVB TEST RESULTS *(continued)*

Performance waveforms are tested on the evaluation board.

$V_{IN} = 3.6V$, $V_{CC} = 3.6V$, $R_{LIM} = 10.5k\Omega$, $T_A = 25^\circ C$, unless otherwise noted.

I_{LIM} vs. Temperature

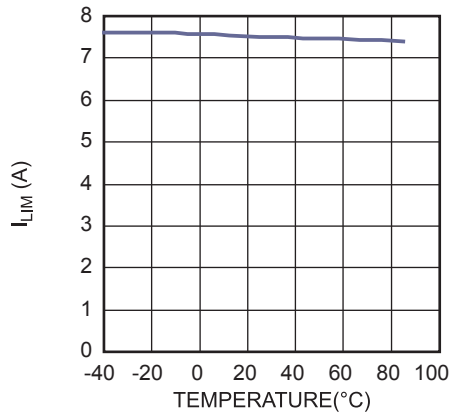

Soft-Start vs. Cap

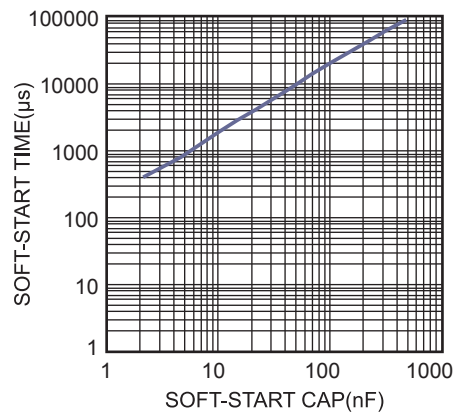

Case Temperature Rise vs. Output Current

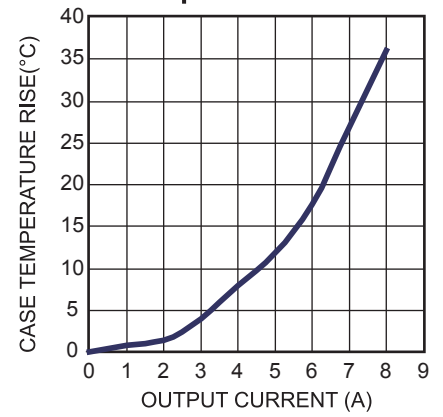

EVB TEST RESULTS (continued)

Performance waveforms are tested on the evaluation board.

V_{IN} = 3.6V, V_{CC} = 3.6V, R_{LIM} = 10.5kΩ, T_A = 25°C, unless otherwise noted.

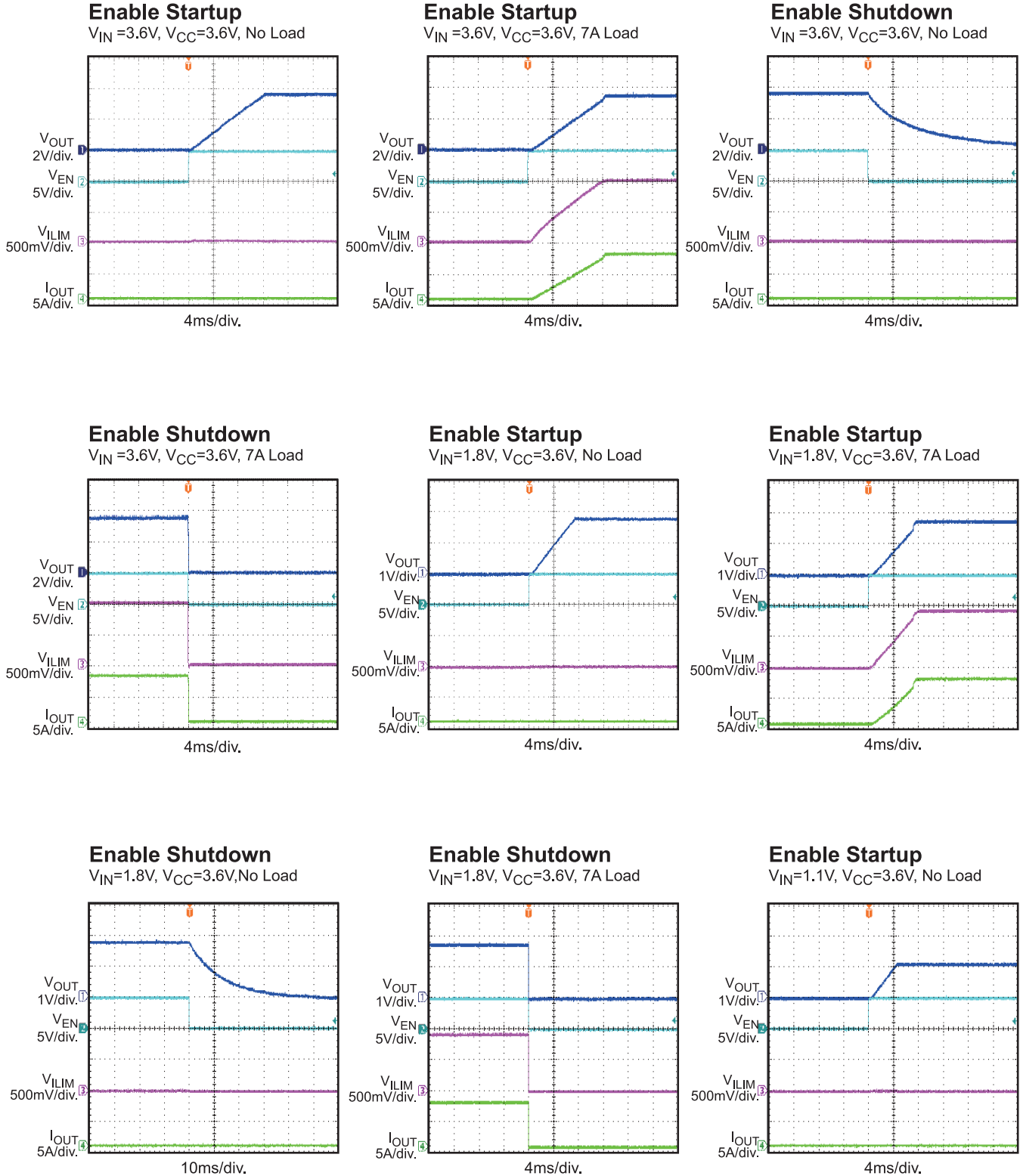

EVB TEST RESULTS (continued)

Performance waveforms are tested on the evaluation board.

V_{IN} = 3.6V, V_{CC} = 3.6V, R_{LIM} = 10.5kΩ, T_A = 25°C, unless otherwise noted.

Enable Startup

V_{IN} = 1.1V, V_{CC} = 3.6V, 7A Load

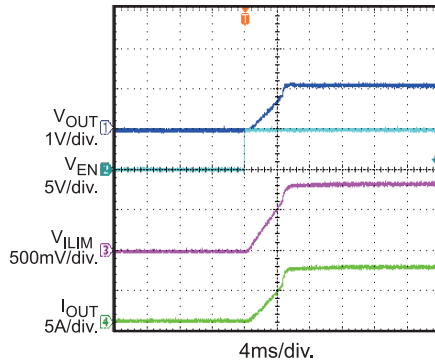

Enable Shutdown

V_{IN} = 1.1V, V_{CC} = 3.6V, No Load

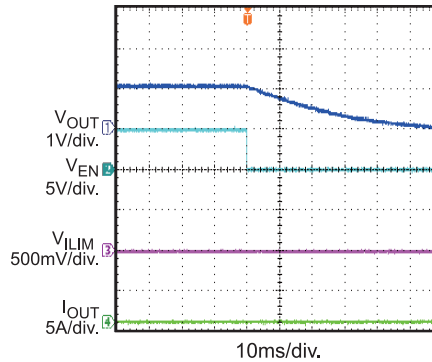

Enable Shutdown

V_{IN} = 1.1V, V_{CC} = 3.6V, 7A Load

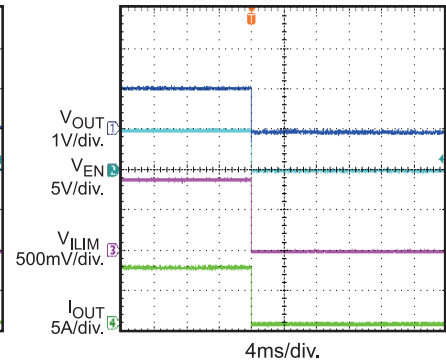

Power Up

V_{IN} = 3.6V, V_{CC} = 3.6V, No Load

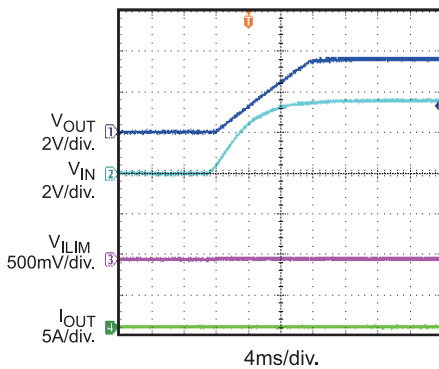

Power Up

V_{IN} = 3.6V, V_{CC} = 3.6V, 7A Load

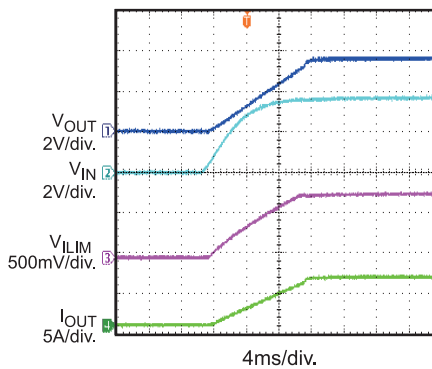

Power Down

V_{IN} = 3.6V, V_{CC} = 3.6V, No Load

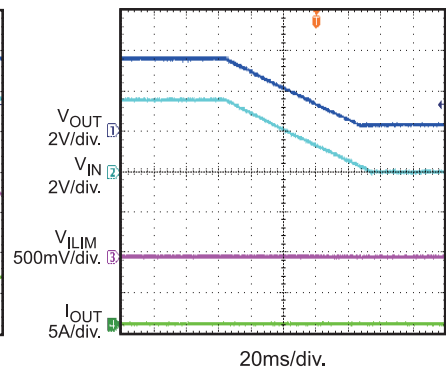

Power Down

V_{IN} = 3.6V, V_{CC} = 3.6V, 7A Load

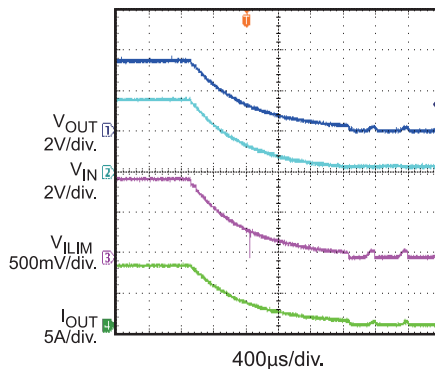

Steady State

V_{IN} = 3.6V, V_{CC} = 3.6V, 7A Load

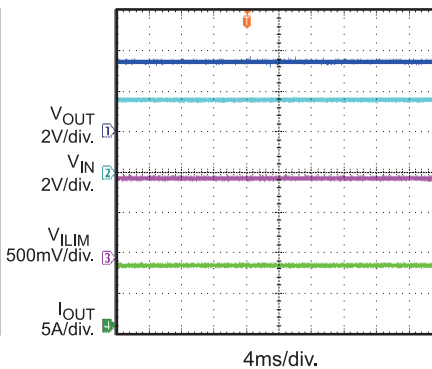

Load Transient Response

V_{IN} = 5V, V_{CC} = 3.3V, I_{OUT} = 0A to 7A

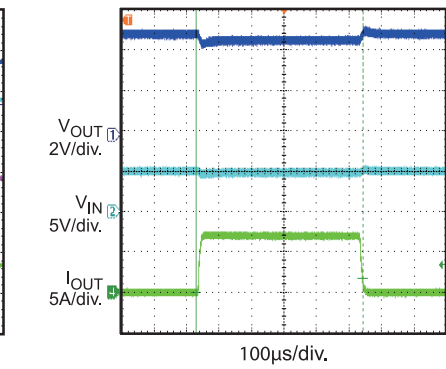

EVB TEST RESULTS *(continued)*

Performance waveforms are tested on the evaluation board.

$V_{IN} = 3.6V$, $V_{CC} = 3.6V$, $R_{LIM} = 10.5k\Omega$, $T_A = 25^\circ C$, unless otherwise noted.

SCP Entry

$V_{IN} = 5V$, $V_{CC} = 3.3V$, $R_{LIM} = 10.5k$

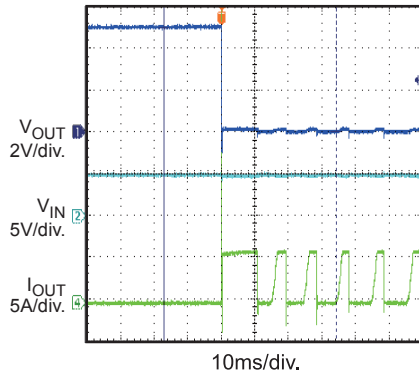

SCP Steady State

$V_{IN} = 5V$, $V_{CC} = 3.3V$, $R_{LIM} = 10.5k$

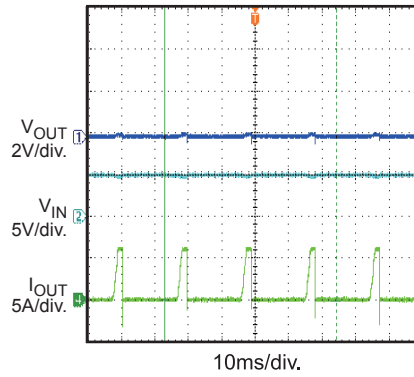

SCP Recovery

$V_{IN} = 5V$, $V_{CC} = 3.3V$, $R_{LIM} = 10.5k$

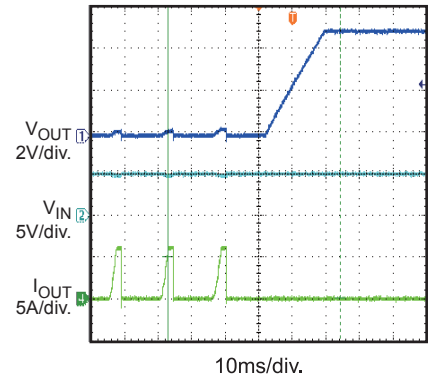

PRINTED CIRCUIT BOARD LAYOUT

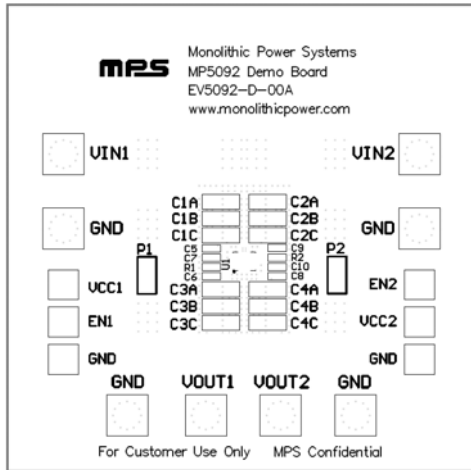

Figure 1—Top Silk Layer

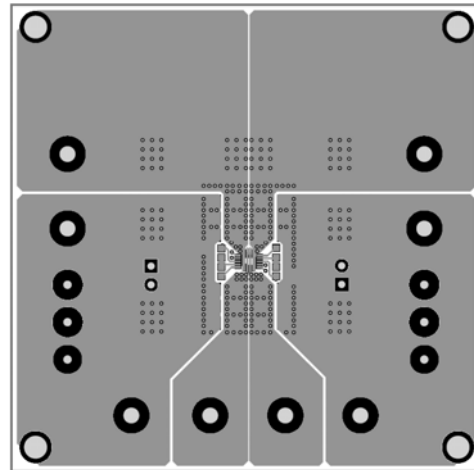

Figure 2—Top Layer

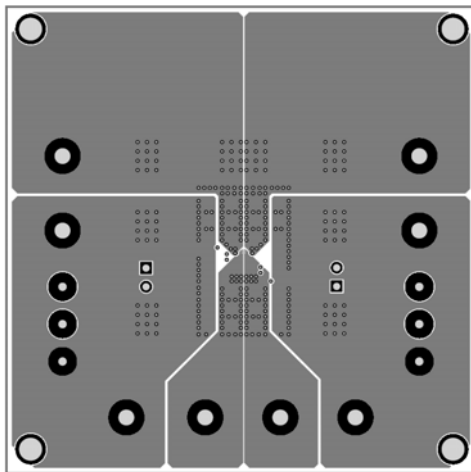

Figure 3—Inner Layer 1

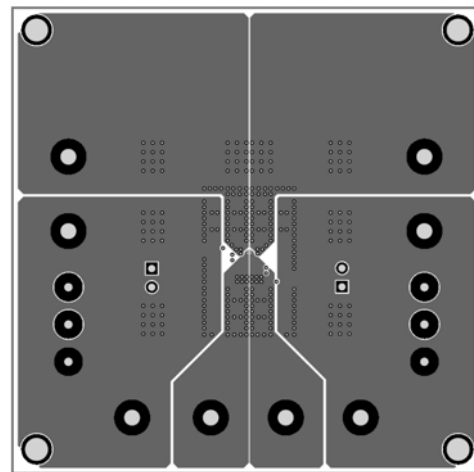

Figure 4—Inner Layer 2

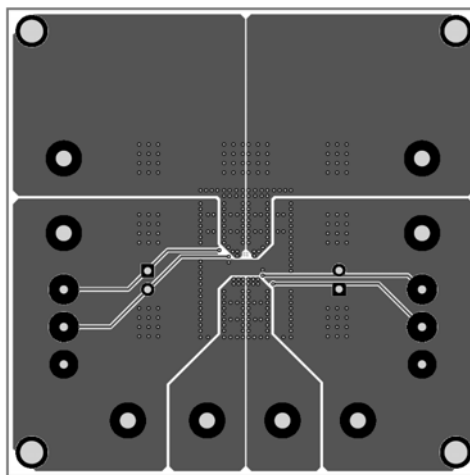

Figure 5—Bottom Layer

QUICK START GUIDE

1. Connect the positive and negative terminals of the load to the VOUT1/2 and GND pins respectively.
2. Preset the power supply output between 0.5V and 5.5V, and then turn off the power supply.
3. Connect the positive and negative terminals of the power supply output to the VIN1/2 and GND pins respectively.
4. Follow the step 1-3 to set the VCC1/2 voltage between 3V and 5.5V.
5. Turn the power supply on.
6. To use the Enable function, apply a digital input to the EN1/2 pin. Drive EN1/2 higher than 1.5V to turn on the switch or less than 1.1V to turn it off.
7. Use R1/R2 to set the output current limit and C6/C9 to set the SS time. Follow the Application Information section in the device datasheet to select appropriate R1/R2, C6/C9.

NOTICE: The information in this document is subject to change without notice. Please contact MPS for current specifications. Users should warrant and guarantee that third party Intellectual Property rights are not infringed upon when integrating MPS products into any application. MPS will not assume any legal responsibility for any said applications.