

DESCRIPTION

The EV5090-C-00A is an evaluation board for the MP5090, a low IQ dual channel load switch.

The MP5090 integrated a dual load switches to provide load protection covering 0.5V to 5.5V voltage range. Each channel provides up to 3A/2A load protection covering 0.5V to 5.5V voltage range with 1.85V V_{CC} power supply. With the small $R_{DS(on)}$ in tiny package, MP5090 provide very high efficient and space saving solution in notebook and tablet or other portable devices application.

With the internal soft start function, the MP5090 can avoid inrush current during circuit start up. MP5090 also provides internal current limit, hiccup protection and thermal shutdown features. MP5090 also easily parallel both channels to double current capability.

The EV board can deliver a continuous 3A load current in each channel and over 0.5V to 5.5V operating input range.

ELECTRICAL SPECIFICATION

Parameter	Symbol	Value	Units
Input Voltage ⁽¹⁾	V_{IN}	0.5-5.5	V
Vcc Voltage	V_{CC}	1.85-5.5	V
Output Current	I_{OUT}	2/2	A

Note:

1) For specifications of lower voltage, please contact factory.

FEATURES

- Low Quiescent Current: 40 μ A
- Wide V_{IN} Range from 0.5V to 5.5V
- <1 μ A Shutdown Current
- Output Discharge Function
- Continuous Current Capability
MP5090GQHT: 3A
MP5090GC: 2A
- Integrated Low $R_{DS(on)}$ FETs
MP5090GQHT: 20m Ω
MP5090GC: 30m Ω
- Enable Pin
- Short-Circuitry Response Protection
- Easily Parallel Connect Dual Channel
- Support Reverse Block Connection
- Thermal Protection
- Small thin TQFN 1.5mmx2.0mm and 8-ball CSP 1.05mmx1.60mm Package for Space Saving

APPLICATIONS

- Notebook and Tablet Computers
- Portable Devices
- Solid State Drives
- Handheld Devices

All MPS parts are lead-free, halogen free, and adhere to the RoHS directive. For MPS green status, please visit MPS website under Quality Assurance. "MPS" and "The Future of Analog IC Technology" are Registered Trademarks of Monolithic Power Systems, Inc.

EV5090-C-00A EVALUATION BOARD

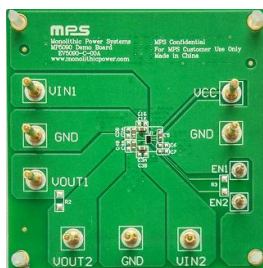

(L x W x H) 6.4cm x 6.4cm x 1.3cm

Board Number	MPS IC Number
EV5090-C-00A	MP5090GC

$R_{DS(on)}$ vs. V_{CC} (CSP)

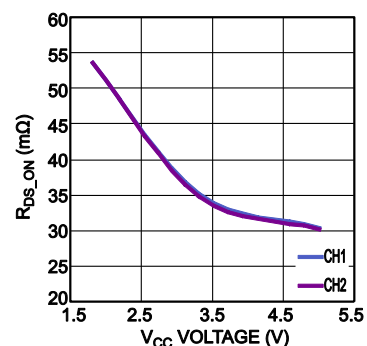

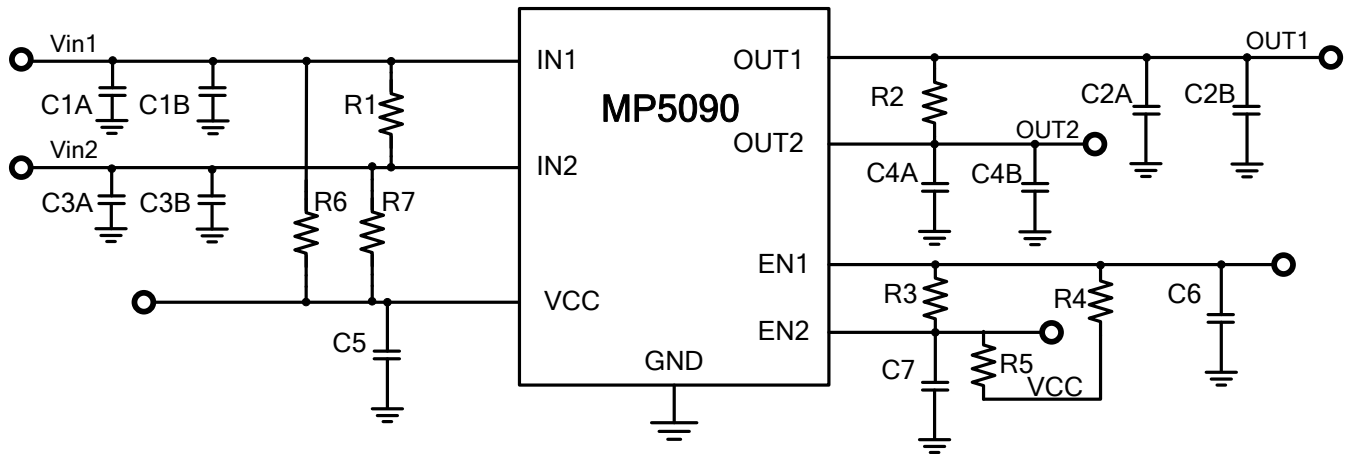
EVALUATION BOARD SCHEMATIC

EV5090-C-00A BILL OF MATERIALS

Qty	Ref	Value	Description	Package	Manufacturer	Manufacturer P/N
4	C1A, C2A, C3A, C4A	10 μ F	Ceramic Cap, 6.3V,X5R	0603	muRata	GRM188R60J106ME47D
1	C5	1 μ F	Ceramic Cap, 6.3V,X5R	0603	muRata	GRM188R60J105KA01D
1	U1	MP5090	Dual Channel Switch	1.6mmx1.05mm	MPS	MP5090GC
0	C1B,C2B, C3B,C4B	NC				
0	C6,C7	NC				
2	R1, R3	0R	Film Res,5%, 1206,0R	1206	YAGEO	RC1206JR-070RL
0	R2	NC				
4	C1A C3A, C2A, C4A	10 μ F	Ceramic Cap., 6.3V,X5R	0603	WE	885012106006
0	C1B C3B,	NC				
0	C2B,C4B	NC				
1	C5	1 μ F	Ceramic Cap., 6.3V,X5R	0603	WE	885012106003
0	C6, C7	NC				
0	R3	NC				
0	R1, R2	NC				
2	R4, R5	10k	Film Res,1%, 1206,10k	1206	YAGEO	RC1206FR-0710KL
1	R6	0	Film Res,1%,1206,0.01R	1206	YAGEO	RC1206FR-0710L
1	U1	MP5090		2mmx2mm	MPS	MP5090GC
0	R7	NC				

EVB TEST RESULTS

Performance waveforms are tested on the evaluation board.

$V_{IN} = 3.6V$, $V_{CC} = 3.6V$, $T_A = 25^\circ C$, unless otherwise noted.

R_{DS_ON} vs. V_{CC} (CSP)

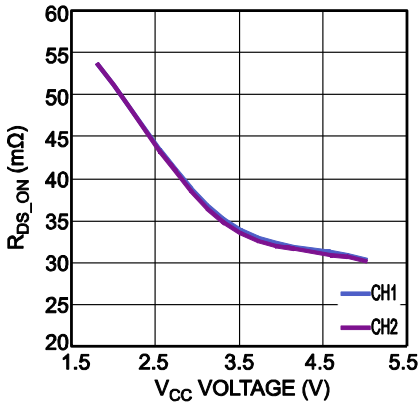

EN Rising Threshold

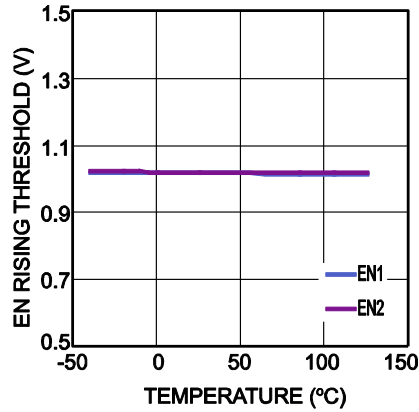

EN Falling Threshold

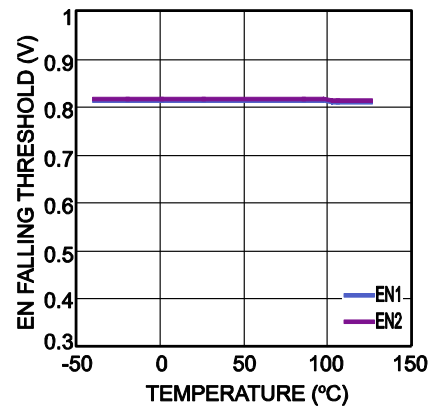

V_{CC} Rising Threshold

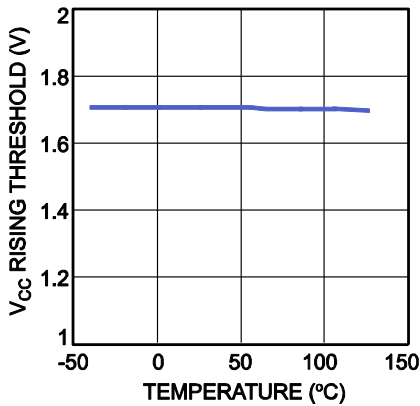

V_{CC} Falling Threshold

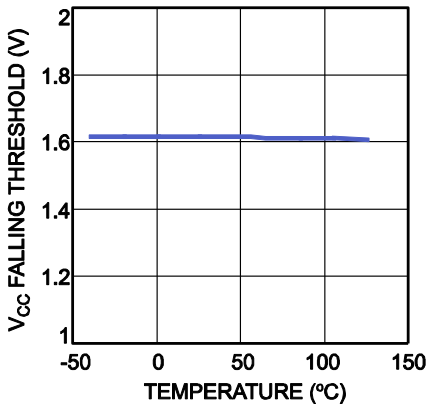

EVB Test Results (continued)

Performance waveforms are tested on the evaluation board.

 $V_{IN} = 3.6V$, $V_{CC} = 3.6V$, $T_A = 25^\circ C$, unless otherwise noted.

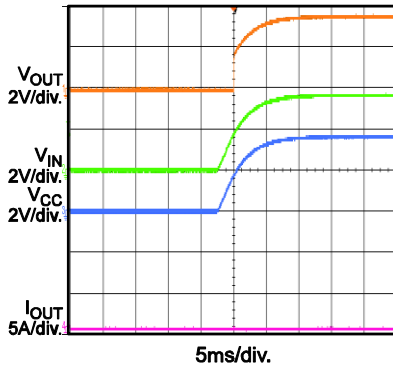
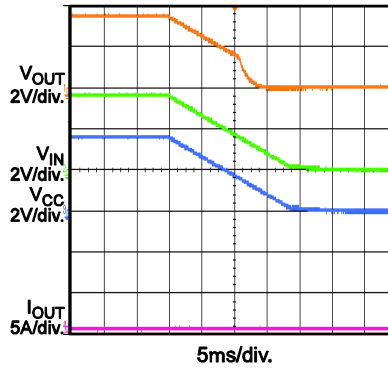
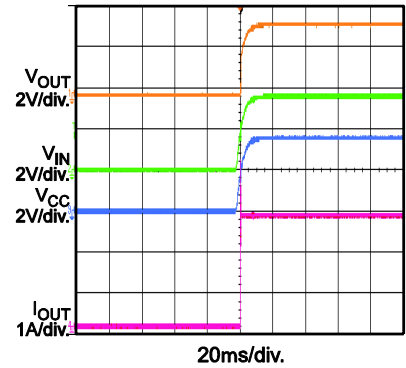
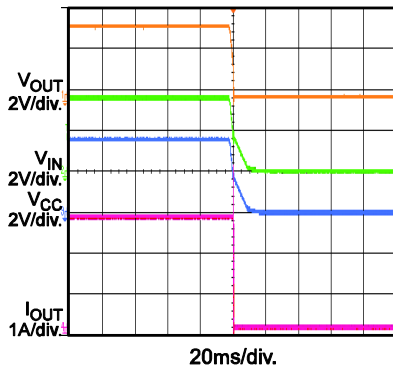
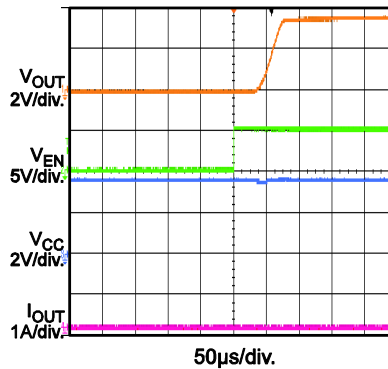
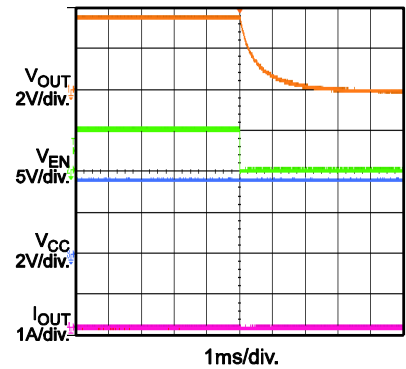
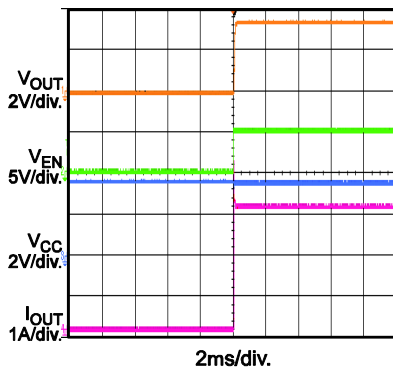
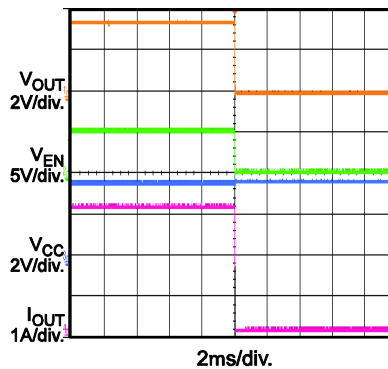
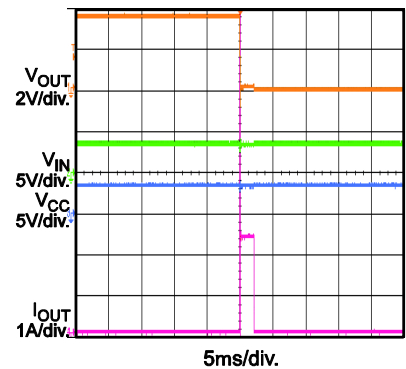
 V_{IN} Start-Up
with No Load

 V_{IN} Shutdown
with No Load

 V_{IN} Start-Up
with 3A Load

 V_{IN} Shutdown
with 3A Load

EN Start-Up
with No Load

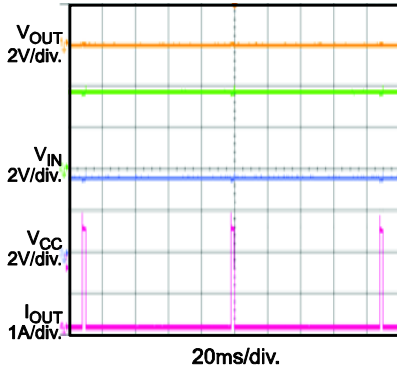
EN Shutdown
with No Load

EN Start-Up
with 3A Load

EN Shutdown
with 3A Load

Short Enter

EVB TEST RESULTS *(continued)*

Performance waveforms are tested on the evaluation board.

$V_{IN} = 3.6V$, $V_{CC} = 3.6V$, $T_A = 25^\circ C$, unless otherwise noted.

Short Steady State



Short Recovery

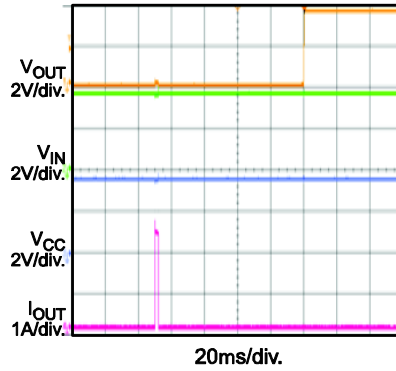

V_{IN} Start-Up with Short

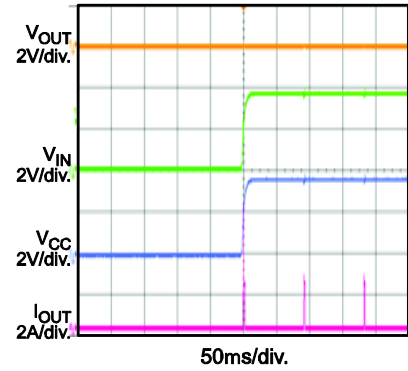

V_{IN} Shutdown with Short

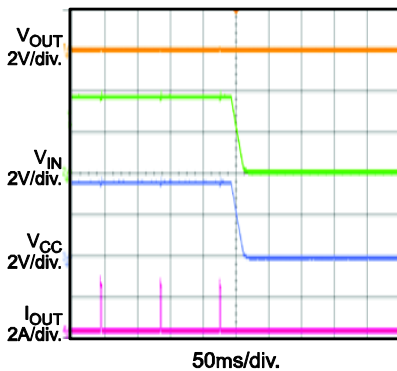

EN Start-Up with Short

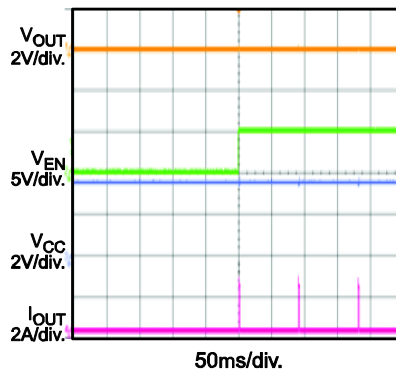

EN Shutdown with Short

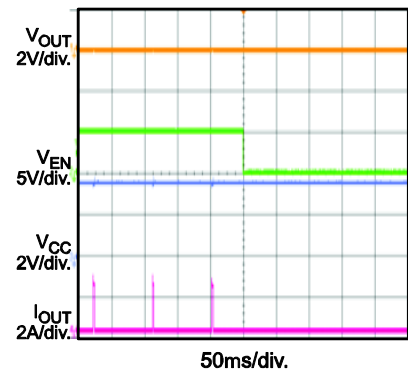

Short Enter (Parallel)

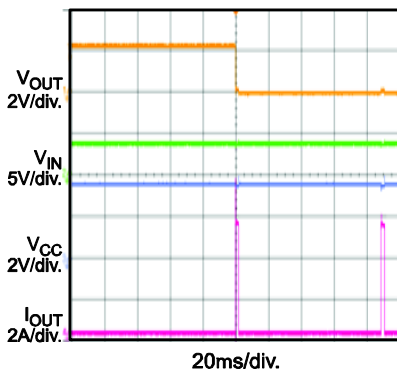

Short Steady (Parallel)

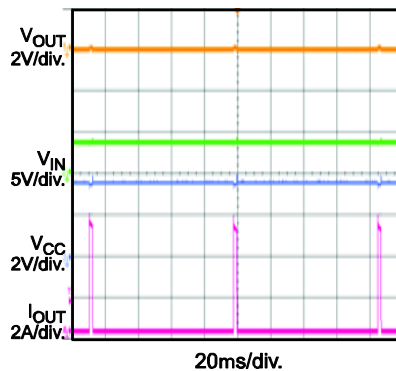

Short Recovery (Parallel)

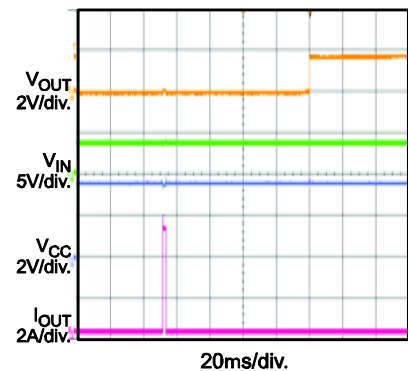

PRINTED CIRCUIT BOARD LAYOUT

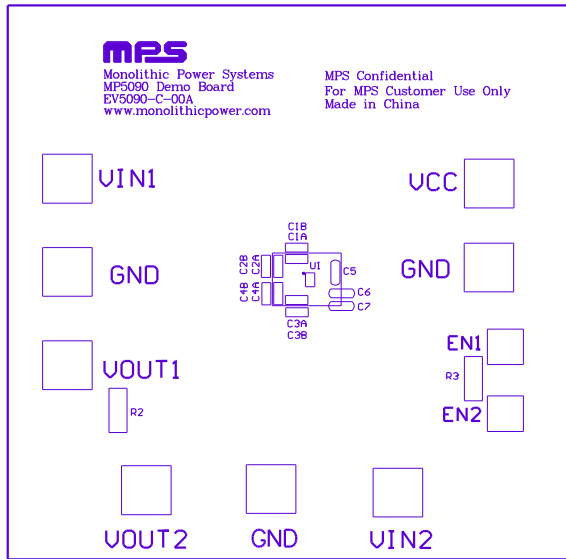

Figure 1—Top Silk Layer

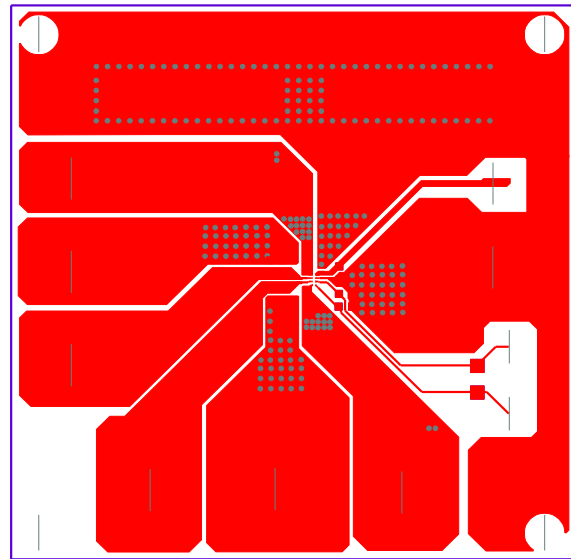

Figure 4—Top Layer

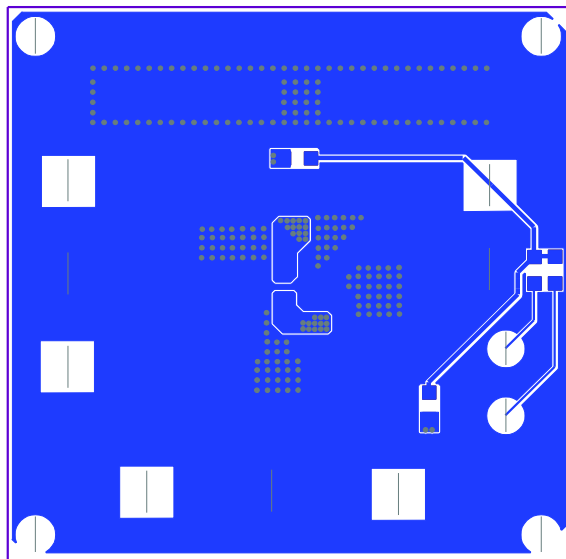

Figure 3—Bottom Layer

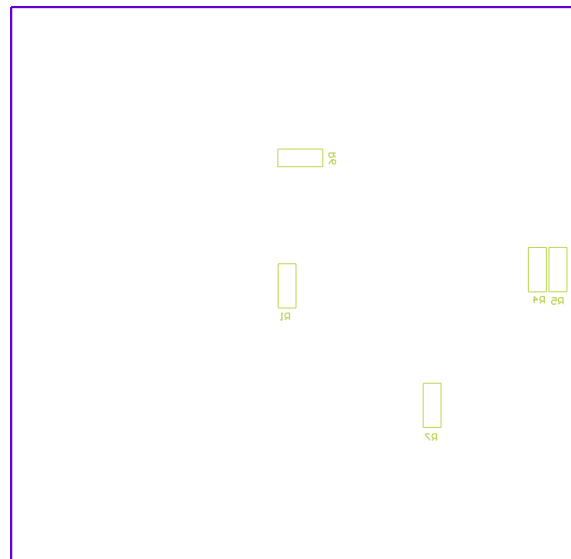

Figure 4—Bottom Silk Layer

QUICK START GUIDE

1. Connect the positive and negative terminals of the load to the V_{OUT1} , V_{OUT2} and GND pins, respectively.
2. Preset the power supply output between 0.5V and 5.5V, and then turn off the power supply.
3. Connect the positive and negative terminals of the power supply output to the V_{IN1} , V_{IN2} , and GND pins, respectively.
4. Turn the power supplies on and MP5090 will start up automatically.
5. Drive $EN_{1/2}$ voltage less than 0.8V to turn it off.
6. Remove R6 and set R7 to 0Ω when use V_{in2} as the power supply of V_{cc} .

NOTICE: The information in this document is subject to change without notice. Please contact MPS for current specifications. Users should warrant and guarantee that third party Intellectual Property rights are not infringed upon when integrating MPS products into any application. MPS will not assume any legal responsibility for any said applications.