



The Future of Analog IC Technology®

# EV5010A-Q-00A

## Programmable Current 5V/1A-5A Electronic Fuse Evaluation Board

### DESCRIPTION

The EV5010A-Q-00A is the evaluation board for the MP5010ADQ, a protection device designed to protect circuitry on the output (source) from transients on input (VCC). It also protects VCC from undesired shorts and transients coming from the source.

Besides the input capacitor and output capacitor, EV5010A-Q-00A contains a low power resistor to set the current limit ( $I_{LIMIT}$ ) as well as a capacitor for dV/dt functions, and the capacitor is optional. The current limit is set to the “trip current ( $I_{TRIP}$ )” level when the output(source voltage) is near Vcc. As the output decreasing, the current limit is decreased to the “hold current ( $I_{HOLD}$ )” level.

The demo board defaults are for a 3V turn on point and a 5.7V over voltage clamp. The trip current is set at 3A, and the hold current is set at 2.1A (22Ω).

### ELECTRICAL SPECIFICATIONS

Parameter	Symbol	Value	Units
Input Voltage	$V_{IN}$	3-18	V
Output Voltage Clamp	$V_{OUT}$	5.7	V
Trip Current	$I_{TRIP}$	3	A
Hold Current	$I_{HOLD}$	2.1	A

### FEATURES

- Adjustable Slew Rate for Output Voltage
- 3A Trip Current and 2.1A Hold Current
- Integrated Power FET Thermal Protection
- Over Voltage Limit

### APPLICATIONS

- Hot Swap
- PC Cards
- Cell Phones
- Laptops

All MPS parts are lead-free and adhere to the RoHS directive. For MPS green status, please visit MPS website under Products, Quality Assurance page. “MPS” and “The Future of Analog IC Technology” are registered trademarks of Monolithic Power Systems, Inc.

## EV5010A-Q-00A EVALUATION BOARD

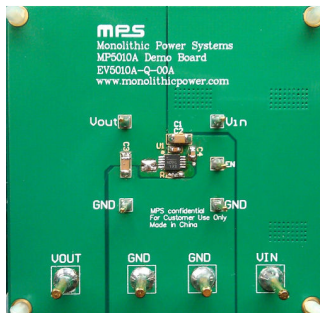

(6.35cm x 6.35cm x 0.3cm)

Board Number	MPS IC Number
EV5010A-Q-00A	MP5010ADQ

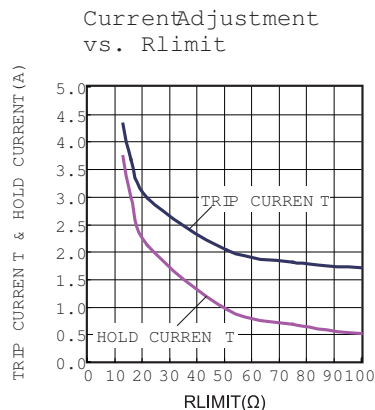

## EVALUATION BOARD SCHEMATIC

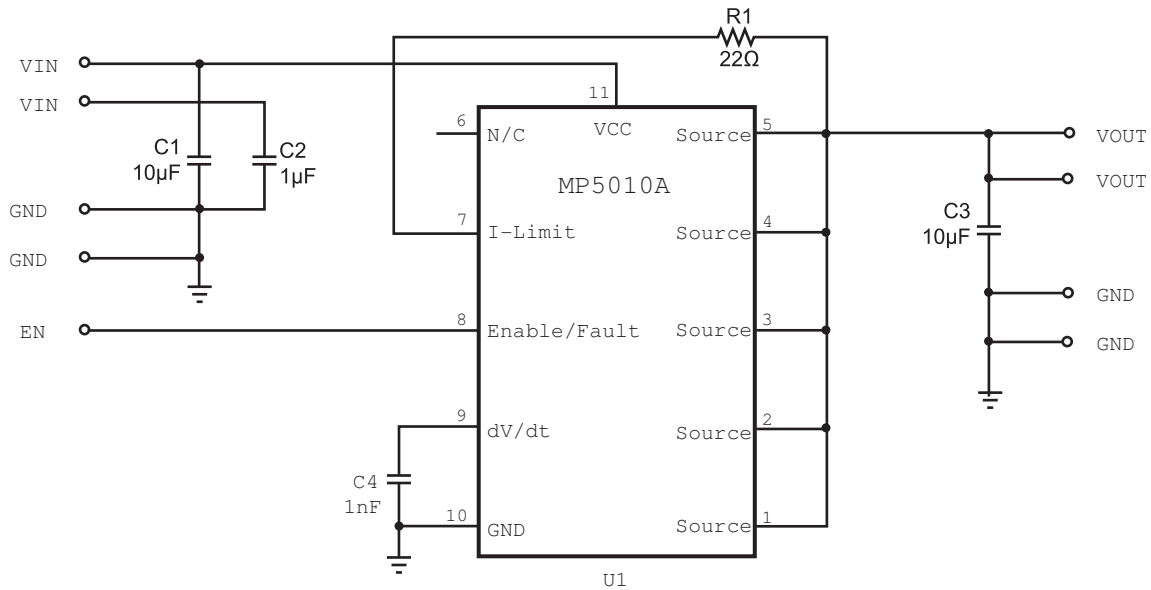

## EV5001DQ-00A BILL OF MATERIALS

Qty	Ref	Value	Description	Package	Manufacturer	Manufacturer P/N
1	C4	1nF	Ceramic Cap., X7R, 50V	0603	Murata	GRM188R71H102KA01D
2	C1,C3	10μF/25V	Ceramic Cap., X5R, 25V	1206	Murata	GRM32DR71E106KA12
					TDK	C3216X5R1E106K
1	C2	1μF	Ceramic Cap., X7R, 16V	0603	Murata	GRM188R71C105KA12D
1	R1	22Ω	Film Res., 1%	0603	Yageo	RC0603FR-0722RL
1	U1		Electronic Fuse	QFN-10	MPS	MP5010ADQ

## EVB TEST RESULTS

Performance waveforms are tested on the evaluation board.

$V_{IN} = 5V$ ,  $V_{EN}=5V$ ,  $R_{LIMIT}=22\Omega$ ,  $C_{OUT}=10\mu F$ ,  $C_{dv/dt} = 1nF$ ,  $T_A=25^\circ C$ , unless otherwise noted.

Startup through  
InputVoltage  
En Float, No Load

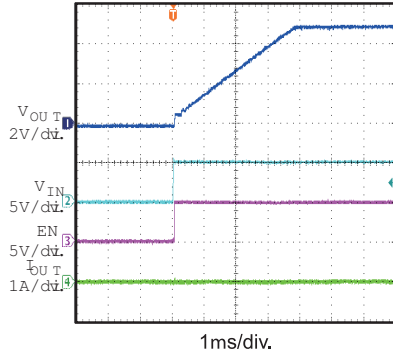

Startup through  
Input Voltage  
En Float,  $R_{LOAD} = 3.3\Omega$

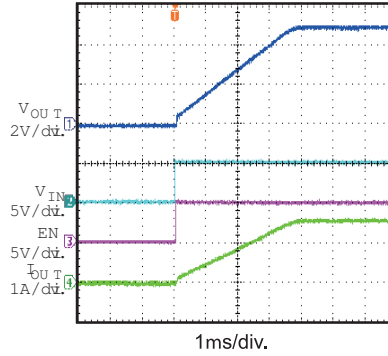

Startup through Enable  
No Load

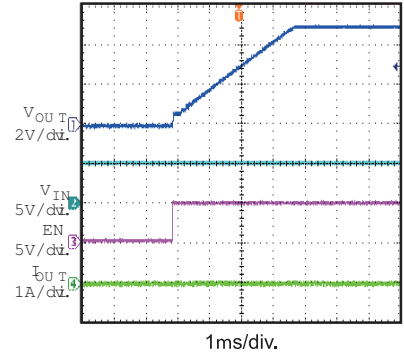

Startup through Enable  
 $R_{LOAD} = 3.3\Omega$

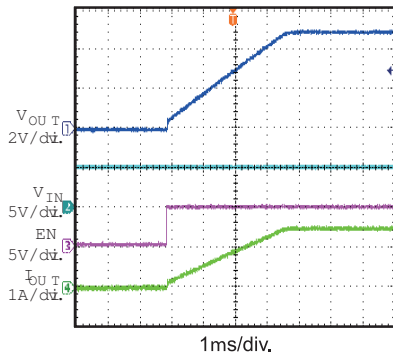

Shutdown through  
InputVoltage  
No Load

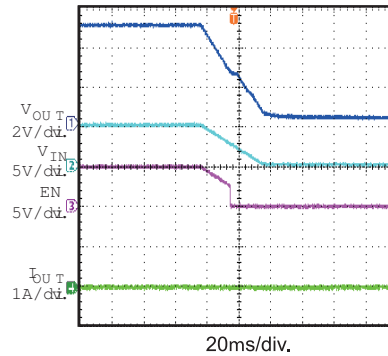

Shutdown through  
Input Voltage  
 $R_{LOAD} = 3.3\Omega$

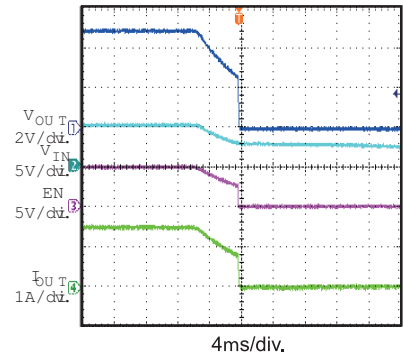

Shutdown through Enable  
No Load

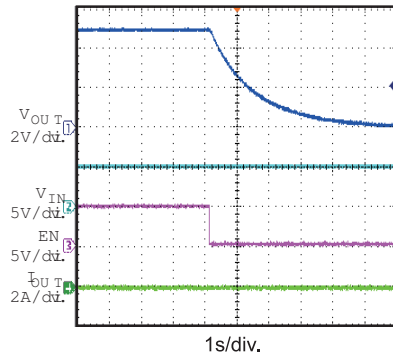

Shutdown Through Enable  
 $R_{LOAD} = 3.3\Omega$

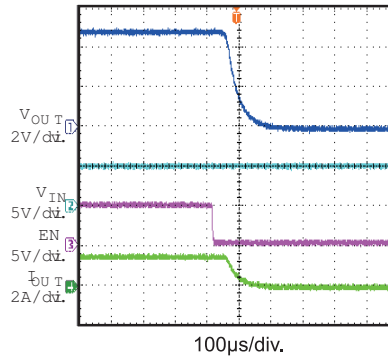

Short Circuit before  
InputVoltage Startup  
and Thermal Shutdown

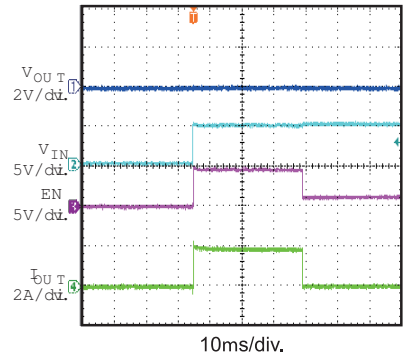

**EVB TEST RESULTS (continued)**

Performance waveforms are tested on the evaluation board.

$V_{IN} = 5V$ ,  $V_{EN}=5V$ ,  $R_{LIMIT}=22\Omega$ ,  $C_{OUT}=10\mu F$ ,  $C_{dv}/dt = 1nF$ ,  $T_A=25^\circ C$ , unless otherwise noted.

Short Circuit during Normal Operation, and Thermal Shutdown

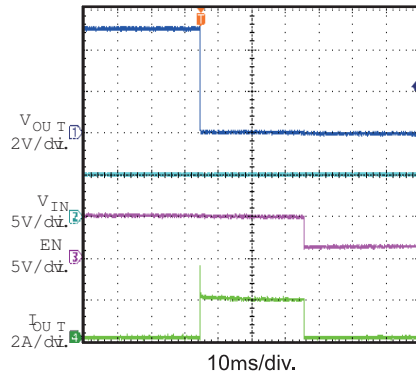

Current Limit

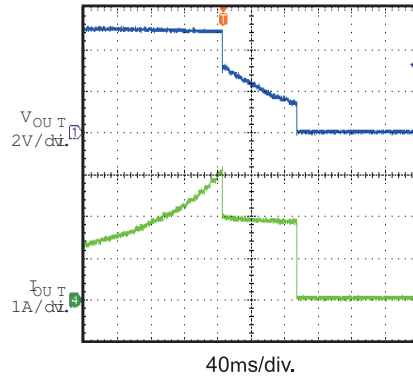

**PRINTED CIRCUIT BOARD LAYOUT**

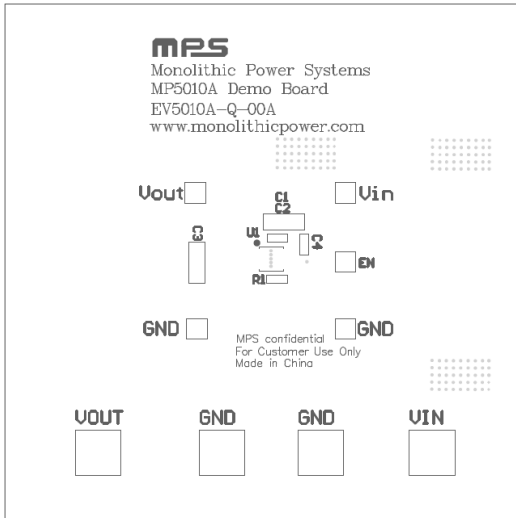

**Figure 1—Top Silk Layer**

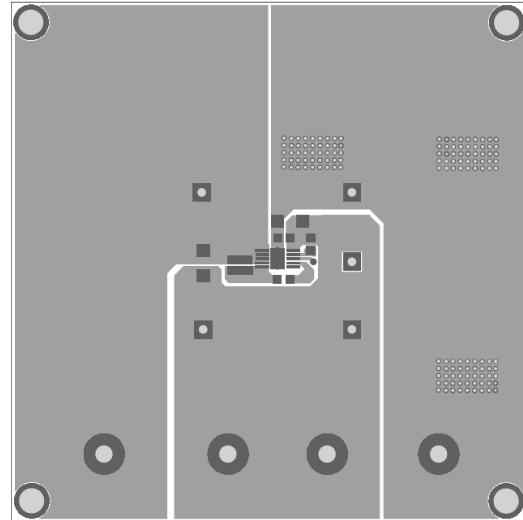

**Figure 2—Top Layer**

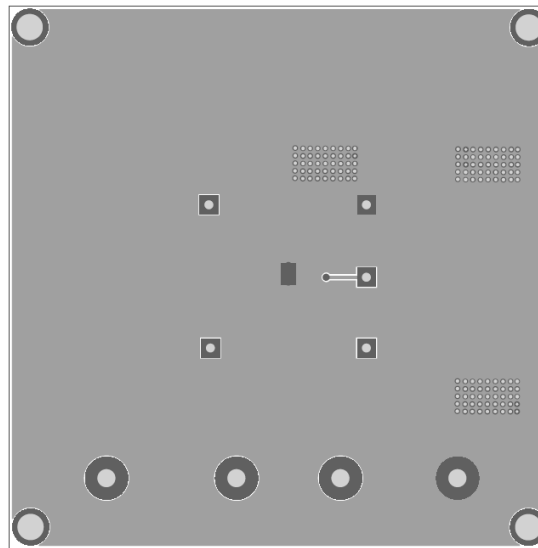

**Figure 3—Bottom Layer**

## QUICK START GUIDE

1. Connect the positive terminal of the load to VOUT pins, and the negative terminal of the load to GND pins.
2. Preset the power supply output to 3V-18V and turn off the power supply.
3. Connect the positive terminal of the power supply output to the VIN pin and the negative terminal of the power supply output to the GND pin.
4. Turn the power supply on. The MP5010ADQ will automatically startup.
5. To use the Enable function, apply a digital input to EN pin. Drive EN higher than 2.5V to turn on the regulator, drive EN less than 0.5V to turn it off.
6. A thermal fault will cause a mid level on the enable pin, and will set the fault flag. Vin restart or a low voltage on EN/FAULT pin can clear fault flag.
7. The trip current value of this board is set to 3A, the hold current value is set to 2.1A. And the output voltage rising time is set to 3ms. Both of the two parameters can be programmed. For detailed application, please refer to the MP5010ADQ datasheet.

**NOTICE:** The information in this document is subject to change without notice. Users should warrant and guarantee that third party Intellectual Property rights are not infringed upon when integrating MPS products into any application. MPS will not assume any legal responsibility for any said applications.