

## DESCRIPTION

The EV4570-F-01A is an evaluation board for the MP4570/MPQ4570, a frequency programmable step-down switching converter with integrated internal high-side and low side power MOSFETs. It can provide 3A continuous output current with peak current control for excellent transient response and efficiency performance.

The wide 4.5V to 55V input voltage range accommodates a variety of step down applications, including those applications in industrial, PoE, automotive and printer with DC high voltage bus.

The valley current detection is used to avoid current running way at over current protection. Also it has accurate and reliable over voltage protection, and auto recovery thermal protection. In addition, the optional external soft start is available. Enable and power good indication function can be used to power track easily. In order to increase the efficiency, MP4570/MPQ4570 will automatically scaling down the switching frequency when load is light. Meanwhile, the low side MOSFET will be turned off to reduce driver loss when zero inductor current is detected. Synchronous operation mode with integrated low side MOSFET is much helpful to reduce the conduction loss and also beneficial to reduce external components space and save the cost.

The MP4570/MPQ4570 is available in a TSSOP-20 EP with exposed pad package.

## ELECTRICAL SPECIFICATIONS

Parameter	Symbol	Value	Units
Input Voltage	$V_{IN}$	4.5-55	V
Output Voltage	$V_{OUT}$	3.3	V
Output Current	$I_{OUT}$	3	A

## FEATURES

- Wide Input Voltage Range: 4.5V to 55V
- Programmable Switching Frequency
- Stable Independent on Output Capacitors
- Optional External Soft Start
- Peak Current Mode Control
- OCP Protection with Valley Current Detection
- Support External SYNC Clock
- OVP Protection
- Current Limit Decreasing during Output Short for Better Thermal Performance
- Power Good Indication
- Thermal Shutdown Protection
- Fully Assembled and Tested

## APPLICATIONS

- PoE Input Non-isolated Buck
- Industrial Power Systems
- Printers and Scanners
- Automotive Power Systems
- Distributed Power Systems

All MPS parts are lead-free, halogen free, and adhere to the RoHS directive. For MPS green status, please visit MPS website under Quality Assurance. "MPS" and "The Future of Analog IC Technology" are Registered Trademarks of Monolithic Power Systems, Inc.

### EV4570-F-01A EVALUATION BOARD



(L x W x H) 2.5" x 2.5" x 0.2"  
(6.4cm x 6.4cm x 0.5cm)

Board Number	MPS IC Number
EV4570-F-01A	MPQ4570GF

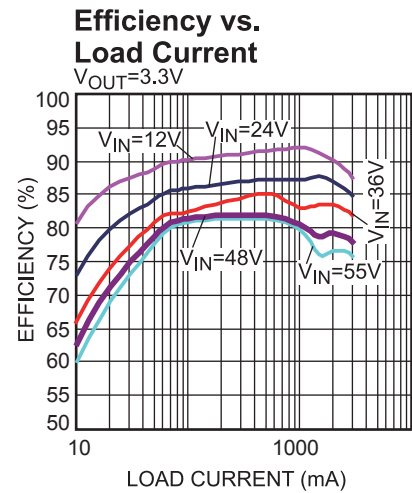

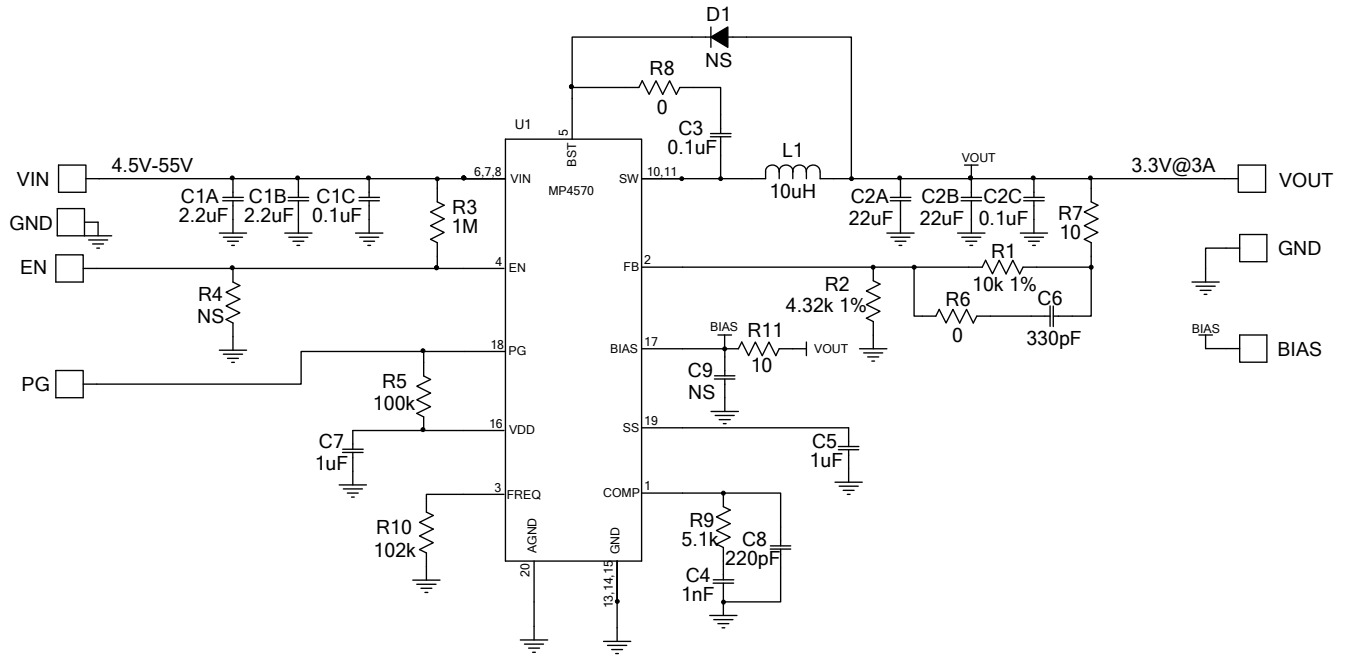
**EVALUATION BOARD SCHEMATIC**

**EV4570-F-01A BILL OF MATERIALS**

Qty	Ref	Value	Description	Package	Manufacturer	Part Number
2	C1A, C1B	2.2 $\mu$ F	Ceramic Capacitor;100V;X7R	1210	muRata	GRM32ER72A225KA35L
1	C1C	0.1 $\mu$ F	Ceramic Capacitor;100V;X7R	0603	muRata	GRM188R72A104KA35D
2	C2A,C2B	22 $\mu$ F	Ceramic Capacitor;16V;X7R	1210	muRata	GRM32ER71C226KE18L
2	C2C,C3	0.1 $\mu$ F	Ceramic Capacitor;16V;X7R	0603	muRata	GRM188R71C104KA01D
1	C4	1nF	Ceramic Capacitor;50V;X7R	0603	muRata	GRM188R71H102KA01D
2	C5,C7	1 $\mu$ F	Ceramic Capacitor;16V;X7R	0603	muRata	GRM188R71C105KA12D
1	C6	330pF	Ceramic Capacitor;50V;C0G	0603	muRata	GRM1885C1H331JA01D
1	C8	220pF	Ceramic Capacitor;50V;C0G	0603	muRata	GRM1885C1H221JA01D
1	C9	NS				
1	R1	10k	Film Resistor;1%;	0603	Yageo	RC0603FR-0710KL
1	R2	4.32k	Film Resistor;1%;	0603	Yageo	RC0603FR-074K32L
1	R3	1M	Film Resistor;5%;	0603	Yageo	RC0603JR-071ML
1	R4	NS				
1	R5	100k	Film Resistor;1%;	0603	Yageo	RC0603FR-07100KL
2	R6,R8	0	Film Resistor;5%;	0603	Yageo	RC0603JR-070RL

**EV4570-F-00A BILL OF MATERIALS (continued)**

Qty	Ref	Value	Description	Package	Manufacturer	Part Number
2	R7,R11	10	Film Resistor;1%;	0603	Yageo	RC0603FR-0710RL
1	R9	5.1k	Film Resistor;1%;	0603	Yageo	RC0603FR-075K1L
1	R10	102k	Film Resistor;1%;	0603	Yageo	RC0603FR-07102KL
1	D1	NS				
1	L1	10 $\mu$ H	Inductor;5.8A;25.4mohm DCR	SMD	ABC	CU1048100YEB
			Inductor;5.2A;30mohm DCR	SMD	Wurth	74437368100
1	U1		Synchronous Step-Down Converter	TSSOP20	MPS	MPQ4570GF
4	VIN, GND, GND, VOUT		2.0 Golden Pin		HZ	
11	PG,GND, EN,GND, BIAS		2.54mm Test Pin		Any	

## EVB TEST RESULTS

$V_{IN} = 48V$ ,  $V_{OUT} = 3.3V$ ,  $C_{OUT} = 2 \times 22\mu F$ ,  $L = 10\mu H$ ,  $f_{SW} = 500kHz$ ,  $T_A = +25^\circ C$ , unless otherwise noted.

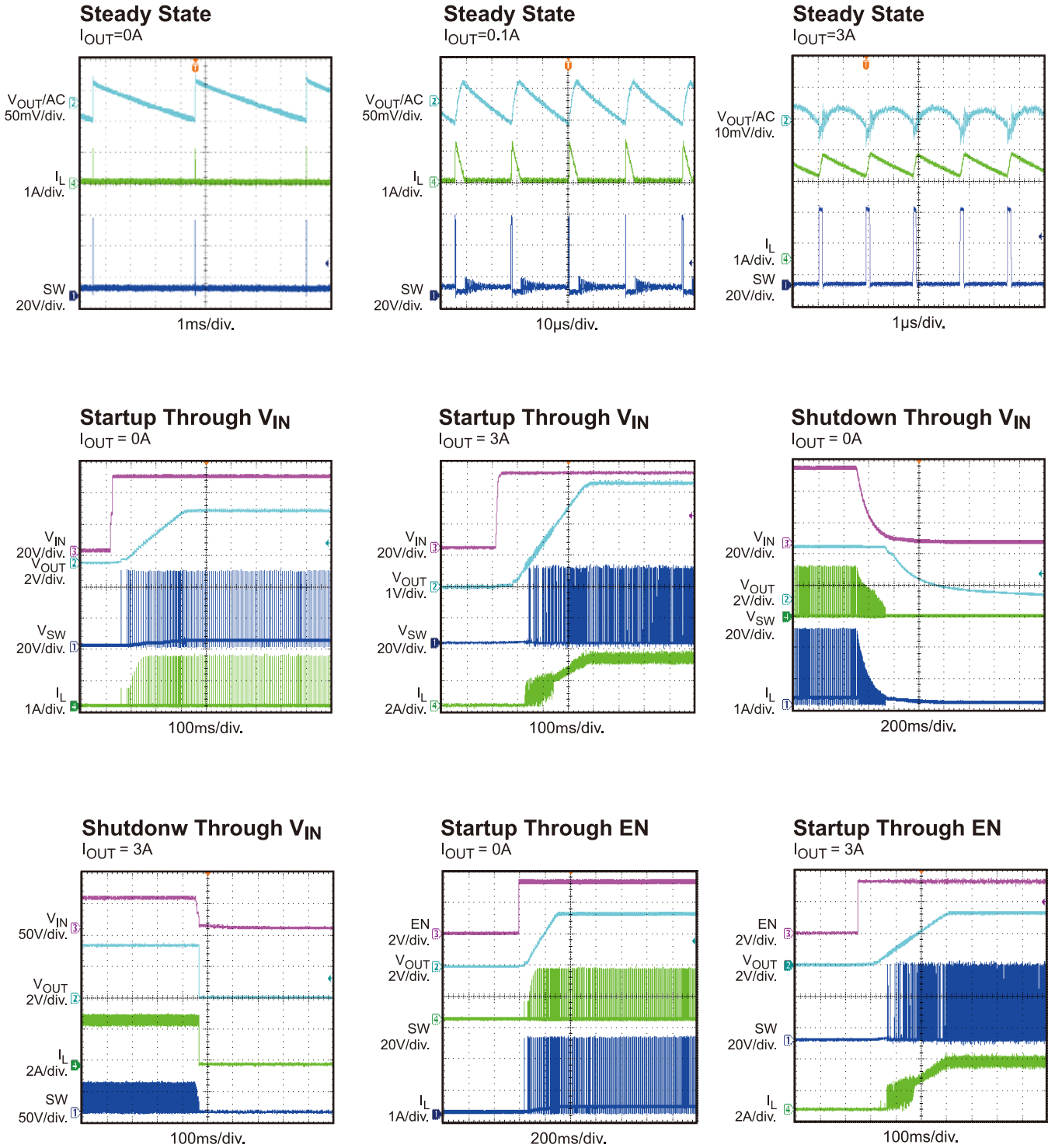

## EVB TEST RESULTS

$V_{IN} = 48V$ ,  $V_{OUT} = 3.3V$ ,  $C_{OUT} = 2x22\mu F$ ,  $L = 10\mu H$ ,  $f_{SW} = 500kHz$ ,  $T_A = +25^\circ C$ , unless otherwise noted.

### Shutdown Through EN

$I_{OUT} = 0A$

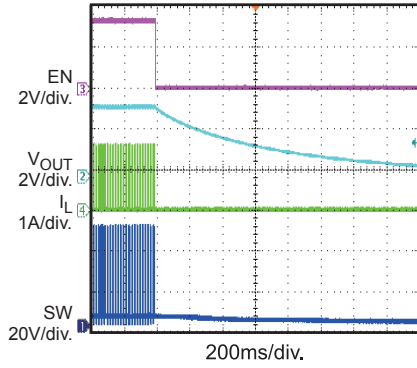

### Shutdown Through EN

$I_{OUT} = 3A$

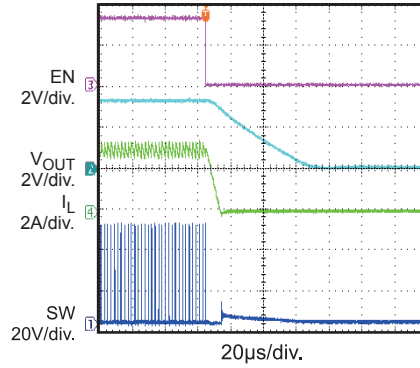

### SCP Entry

$I_{OUT} = 0A$  to Short Circuit

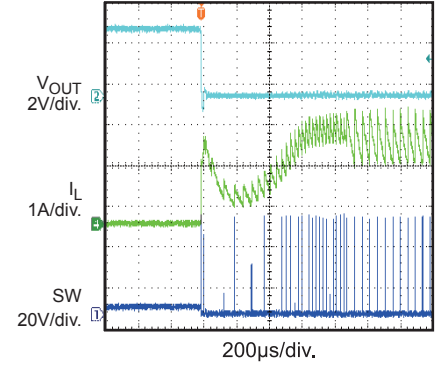

### SCP Entry

$I_{OUT} = 3A$  to Short Circuit

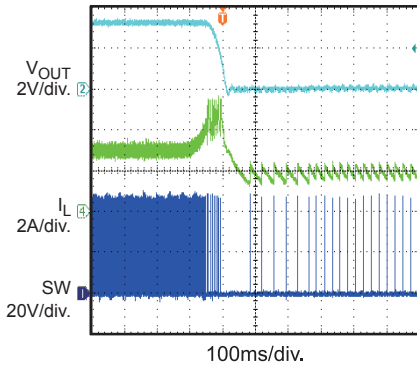

### SCP Steady State

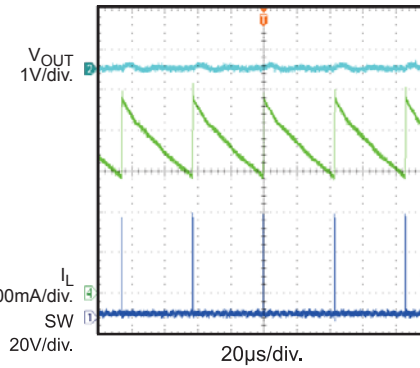

### SCP Recovery

Short Circuit to  $I_{OUT} = 0A$

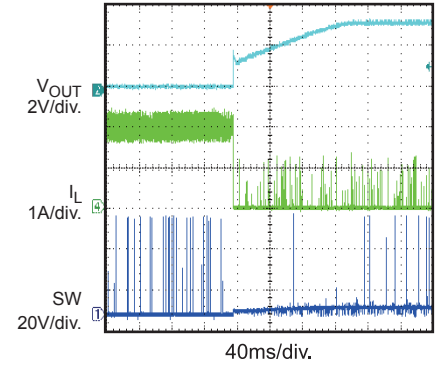

### SCP Recovery

Short Circuit to  $I_{OUT} = 3A$

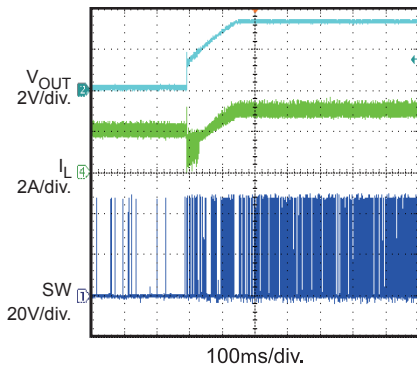

### Load Transient

$I_{OUT} = 1.5A \leftrightarrow 3A$ ,  $1.6A/\mu s$

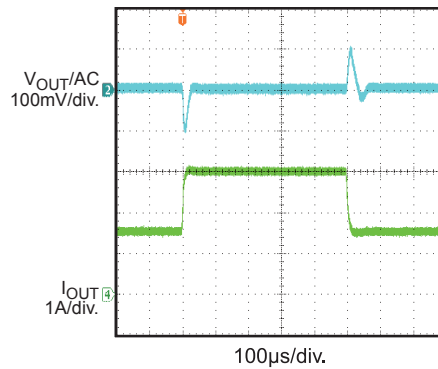

### EVB TEST RESULTS *(continued)*

$V_{IN} = 48V$ ,  $V_{OUT} = 3.3V$ ,  $C_{OUT} = 2 \times 22\mu F$ ,  $L = 10\mu H$ ,  $f_{SW} = 500kHz$ ,  $T_A = +25^\circ C$ , unless otherwise noted.

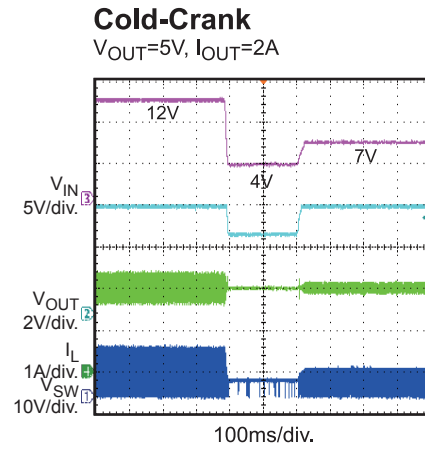
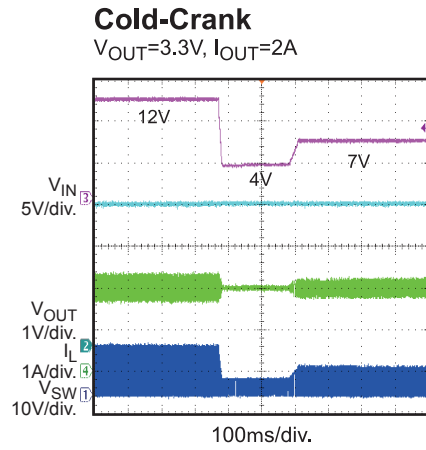

PRINTED CIRCUIT LAYOUT

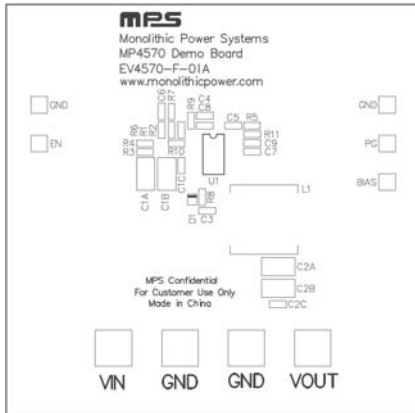

Figure1 – Top Silk Layer

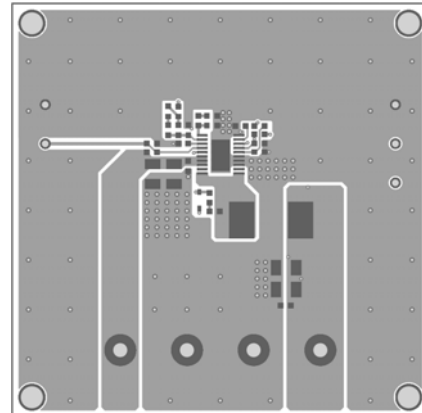

Figure 2 – Top Layer

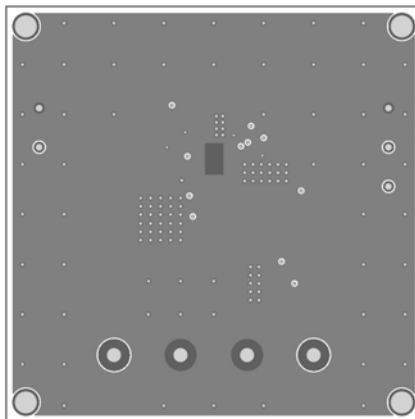

Figure3 – Inner Layer 1

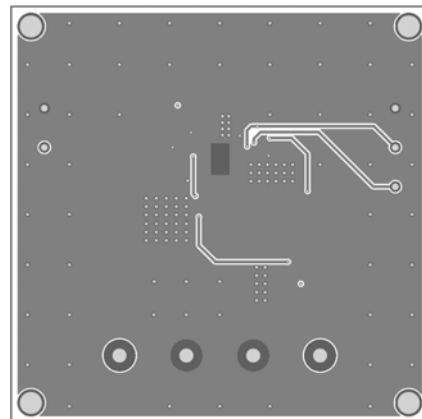

Figure 4 – Inner Layer 2

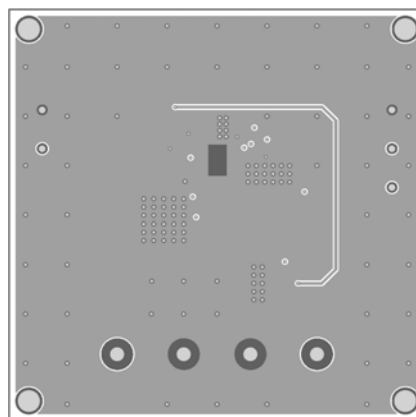

Figure5 – Bottom Layer



## QUICK START GUIDE

1. Connect the positive and negative terminals of the load to the VOUT and GND pins respectively.
2. Preset the power supply output to between 4.5V to 55V, and then turn it off.
3. Connect the positive and negative terminals of the power supply output to the VIN and GND pins respectively.
4. Turn the power supply on. The MP4570/MPQ4570GF will automatically startup.
5. To use the Enable function, apply a digital input to the EN pin. Drive EN higher than 1.6V to turn on the regulator, drive EN less than 1.3V to turn it off. There is no internal pull-up or pull-down circuit, so do not float this pin.
6. Connection the EN pin directly to a voltage source without any pull-up resistors requires limiting voltage amplitude to  $\leq 6V$  to prevent damage to the internal zener diode between EN and GND; EN pin can also be connected to higher voltage (e.g. VIN) through pull-up resistor, but need to make sure the pull-up resistor is high enough to make sure the sink current into EN pin less than  $150\mu A$  to avoid damaging the zener diode. For example, when connecting EN to  $V_{IN}=12V$ ,  $R_{pull-up} \geq (12V - 6.5V) \div 150\mu A = 37k\Omega$ .
7. Use R10 to re-program switching frequency if needed. The recommended  $R_{FREQ}$  values for various  $f_{sw}$  please see Table 1.

**Table 1 —  $f_{sw}$  vs.  $R_{FREQ}$**

$f_{sw}$ (kHz)	$R_{FREQ}$ (k $\Omega$ )
1000	47.5
900	56
800	63.4
700	73.2
600	84.5
500	102
400	133
300	178
200	261
100	523

8. Use R1 and R2 to set the output voltage with  $V_{FB}=1V$ . For  $R1=10k\Omega$ , R2 can be determined by:

$$R2 = \frac{10}{V_{OUT} - 1} k\Omega$$

Follow the Application Information section in the device datasheet to recalculate the compensation, inductor and output capacitor values when output voltage is changed.

**NOTICE:** The information in this document is subject to change without notice. Users should warrant and guarantee that third party Intellectual Property rights are not infringed upon when integrating MPS products into any application. MPS will not assume any legal responsibility for any said applications.