

### DESCRIPTION

The EV4470-L-01A is an evaluation board for the MP/MPQ4470, while EV4470A-L-01A is an evaluation board for the MP/MPQ4470A.

MP/MPQ4470 and MP/MPQ4470A are high-efficiency step-down regulator with integrated power MOSFETs. They offer a very compact solution to achieve a 5A, continuous-output current over a wide input-supply range with excellent load and line regulation. They also provide fast transient response and good stability for wide input-supply and load range. MP/MPQ4470 have OVP latch while MP/MPQ4470A have no this function.

The EV4470-L-01A and EV4470A-L-01A are fully assembled and tested evaluation boards. They generate +3.3V output voltage at load current up to 5A from a 4.5V to 36V input range. Switching frequency of both boards are set at 500kHz.

### ELECTRICAL SPECIFICATIONS

Parameter	Symbol	Value	Units
Input Voltage	V <sub>IN</sub>	4.5 – 36	V
Output Voltage	V <sub>OUT</sub>	3.3	V
Output Current	I <sub>OUT</sub>	5	A

### FEATURES

- Wide 4.5V-to-36V Operating Input Range
- Guaranteed 5A, Continuous Output Current
- Internal 40mΩ High-Side, 20mΩ Low-Side Power MOSFETs
- Proprietary Switching-Loss-Reduction Technology
- 1% Reference Voltage
- Programmable Soft-Start Time
- Low Drop-out Mode
- SCP, OCP, OVP latch (EV4470 only), UVP and Thermal Shutdown

### APPLICATIONS

- Notebook Systems and I/O Power
- Automotive Systems
- Networking Systems
- Industrial Supplies
- Optical Communications Systems
- Distributed Power and POL Systems

All MPS parts are lead-free and adhere to the RoHS directive. For MPS green status, please visit MPS website under Quality Assurance. "MPS" and "The Future of Analog IC Technology" are Registered Trademarks of Monolithic Power Systems, Inc.

### EVALUATION BOARD



(L x W x H) 2.5" x 2.5" x 0.4"  
(6.4cm x 6.4cm x 1.0cm)

Board Number	MPS IC Number
EV4470-L-01A	MPQ4470GL



(L x W x H) 2.5" x 2.5" x 0.4"  
(6.4cm x 6.4cm x 1.0cm)

Board Number	MPS IC Number
EV4470A-L-01A	MPQ4470AGL

## EVALUATION BOARD SCHEMATIC

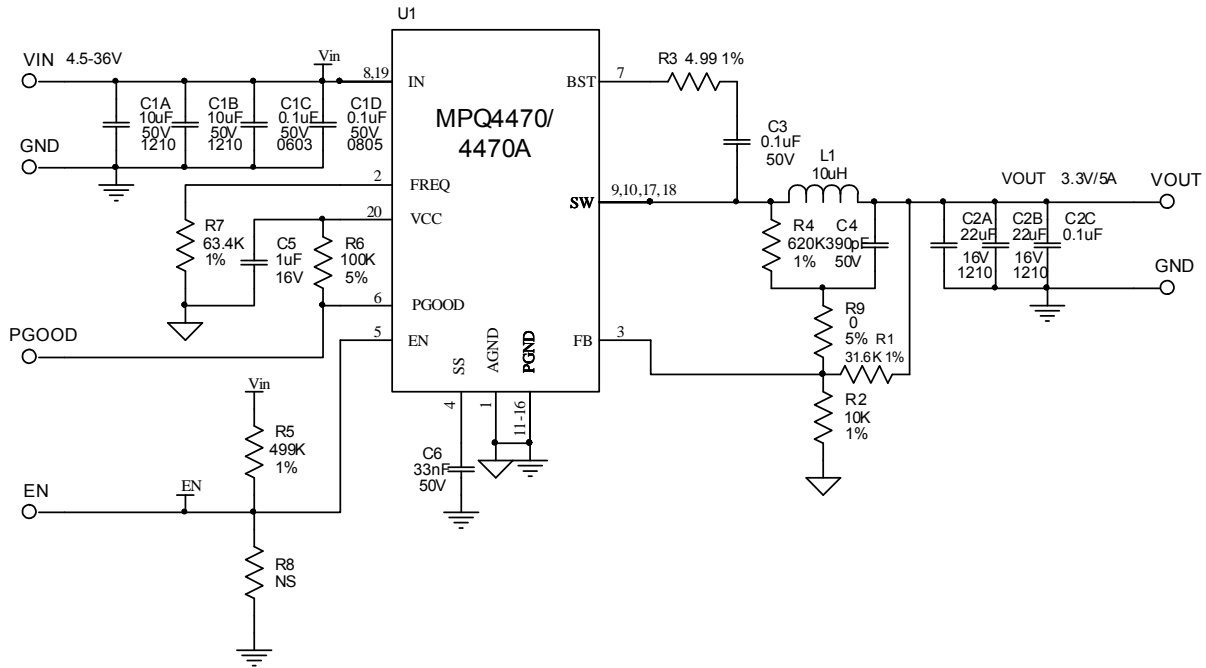

## EV4470/4470A-L-01A BILL OF MATERIALS

Qty	RefDes	Value	Description	Package	Manufacturer	Manufacturer_P/N
2	C1A,C1B	10uF	Ceramic Cap., 50V, X7R	1210	muRata	GRM32ER71H106KA12L
3	C1C,C2C, C3	0.1uF	Ceramic Cap., 50V, X7R	0603	TDK	C1608X7R1H104K
1	C1D	0.1uF	Ceramic Cap., 50V, X7R	0805	muRata	GRM21BR72A104KAC4L
2	C2A,C2B	22uF	Ceramic Cap., 16V, X7R	1210	muRata	GRM32ER71C226KE79
1	C4	390pF	Ceramic Cap., 50V, C0G	0603	muRata	GRM1885C1H391JA01D
1	C5	1uF	Ceramic Cap., 16V, X7R	0603	muRata	GRM188R71C105KA12D
1	C6	33nF	Ceramic Cap., 50V, X7R	0603	muRata	GRM188R71H333KA61D
1	L1	10uH	Inductor, 16.3mOhm, 7.2A	SMD	Wurth	7443251000
1	R1	31.6k	Film Res., 1%	0603	Yageo	RC0603FR-0731K6L
1	R2	10k	Film Res., 1%	0603	Yageo	RC0603FR-0710KL
1	R3	4.99Ω	Film Res., 1%	0603	Yageo	RC0603FR-074R99L
1	R4	620k	Film Res., 1%	0603	Yageo	RC0603FR-07620KL
1	R5	499k	Film Res., 1%	0603	Yageo	RC0603FR-07499KL
1	R6	100k	Film Res., 5%	0603	Yageo	RC0603JR-07100KL
1	R7	63.4k	Film Res., 1%	0603	Yageo	RC0603FR-0763K4L
1	R9	0Ω	Film Res., 5%	0603	Yageo	RC0603JR-070RL
1	R8	NS				
1	U1		Step-Down Regulator	QFN20- 3x4	MPS	MPQ4470GL (for EV4470) MPQ4470AGL (for EV4470A)

## EVB TEST RESULTS

Performance waveforms are tested on the evaluation board.

$V_{IN} = 24V$ ,  $V_{OUT} = 3.3V$ ,  $T_A = 25^\circ C$ , unless otherwise noted.

**Efficiency vs. Load Current**

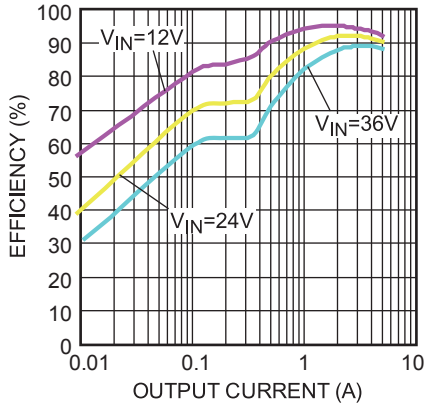

**Case Temperature Rise vs. Output Current**

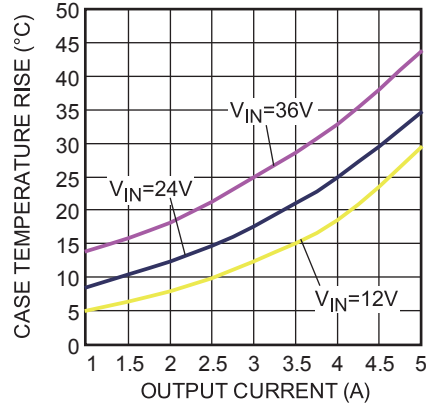

**$F_{SW}$  vs. Output Current**

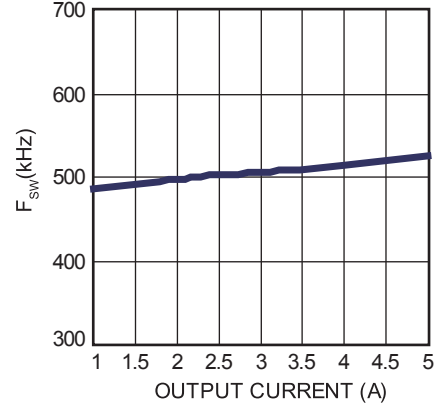

**$F_{SW}$  vs.  $V_{IN}$**

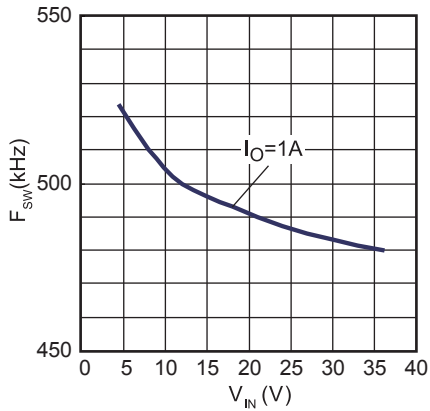

**Line Regulation**

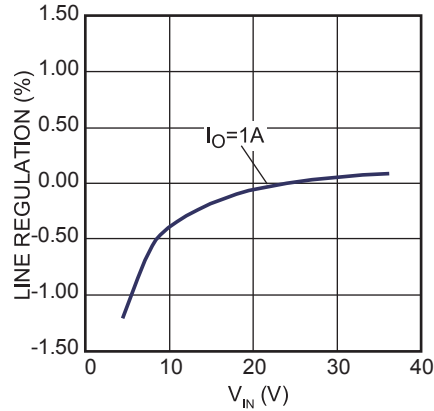

**Load Regulation**

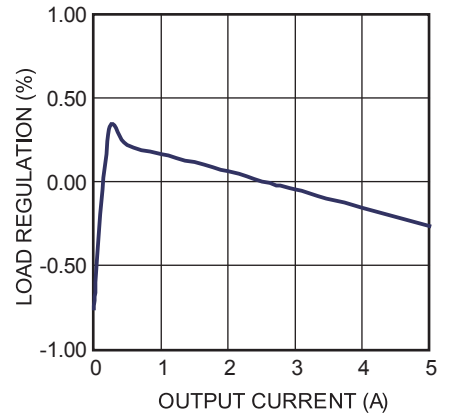

## EVB TEST RESULTS *(continued)*

Performance waveforms are tested on the evaluation board.

$V_{IN} = 24V$ ,  $V_{OUT} = 3.3V$ ,  $T_A = 25^\circ C$ , unless otherwise noted.

**Output Voltage Ripple**  
 $I_O = 0A$

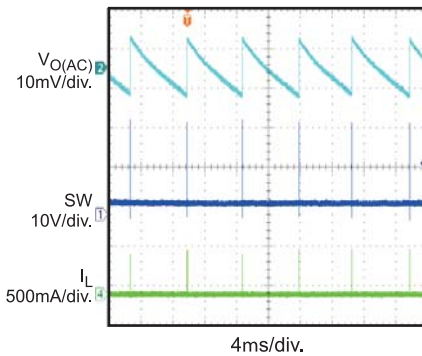

**Output Voltage Ripple**  
 $I_O = 5A$

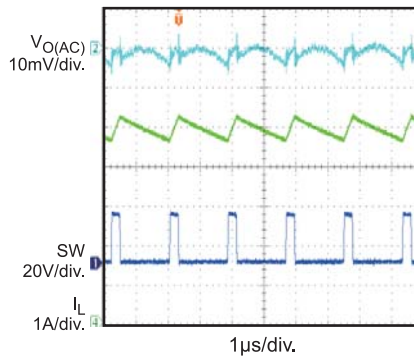

**Start-up Through  $V_{IN}$**   
 $I_O = 0A$

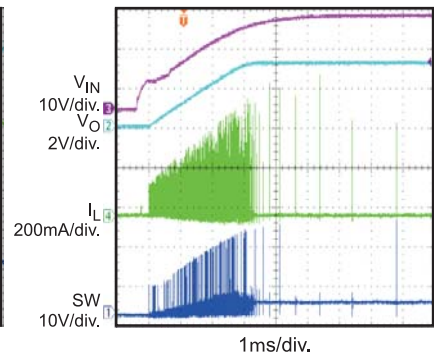

**Start-up Through  $V_{IN}$**   
 $I_O = 5A$

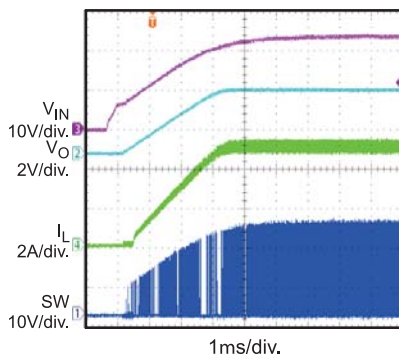

**Shutdown Through  $V_{IN}$**   
 $I_O = 0A$

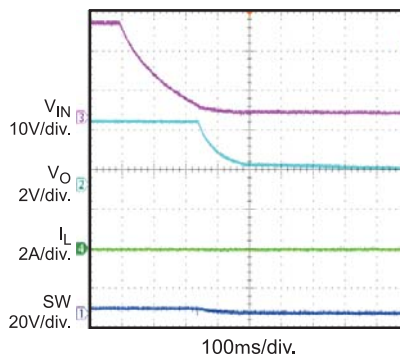

**Shutdown Through  $V_{IN}$**   
 $I_O = 5A$

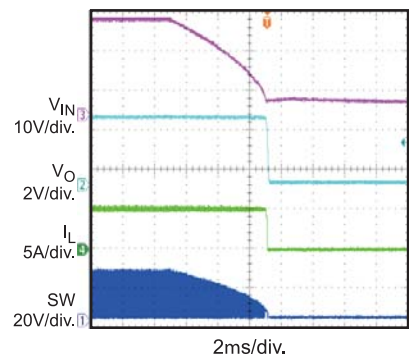

**Start-up Through EN**  
 $I_O = 0A$

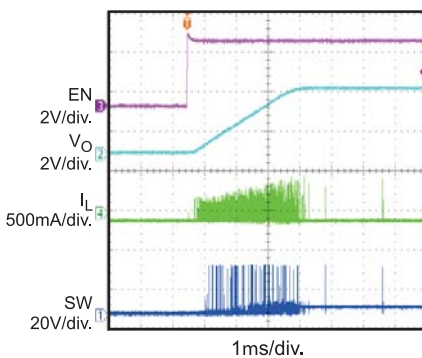

**Start-up Through EN**  
 $I_O = 5A$

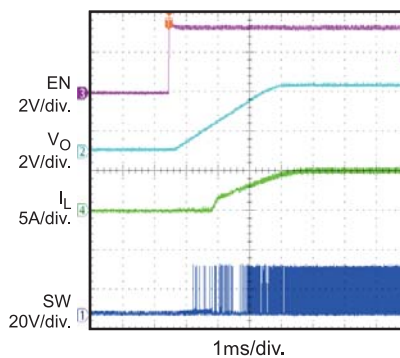

**Shutdown Through EN**  
 $I_O = 0A$

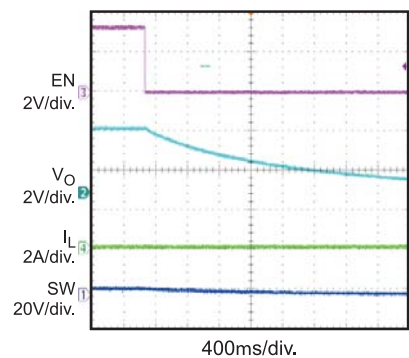

### EVB TEST RESULTS *(continued)*

Performance waveforms are tested on the evaluation board.  
 $V_{IN} = 24V$ ,  $V_{OUT} = 3.3V$ ,  $T_A = 25^{\circ}C$ , unless otherwise noted.

**Shutdown Through EN**  
 $I_O = 5A$

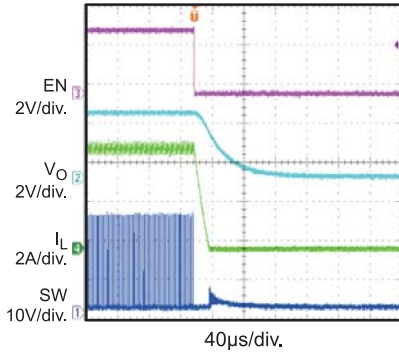

**Short Circuit Entry**  
 $I_O = 0A$

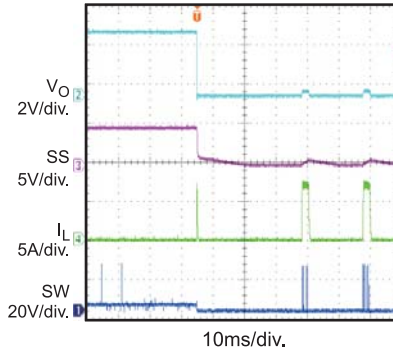

**Short Circuit Entry**  
 $I_O = 5A$

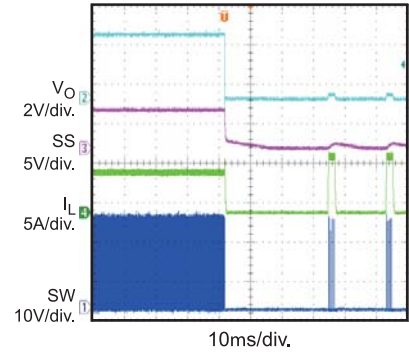

**Short Circuit Steady State**

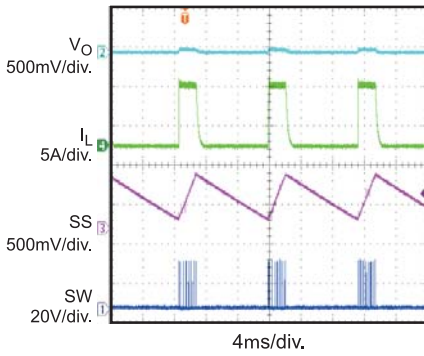

**Load Transient**  
 $I_O = 2.5A-5A@1.6A/\mu s$

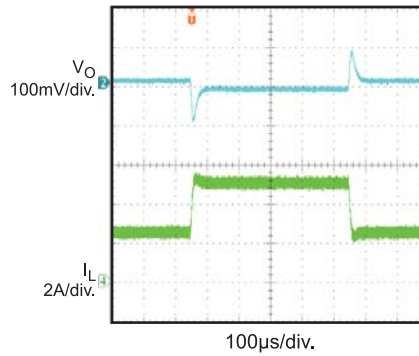

**Short Circuit Recovery**  
 $I_O = 0A$

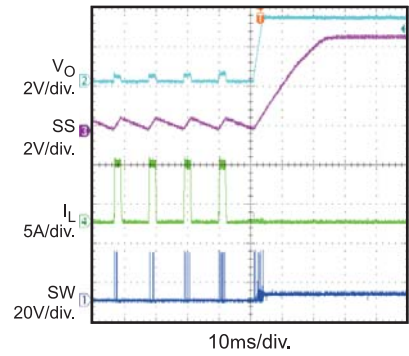

**Short Circuit Recovery**  
 $I_O = 5A$

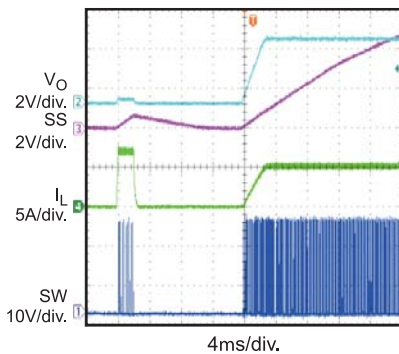

**Power Good Through EN Start-up**

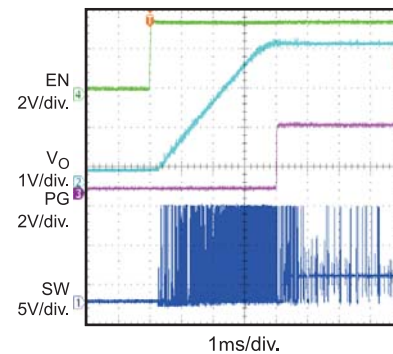

**Power Good Through EN Shutdown**

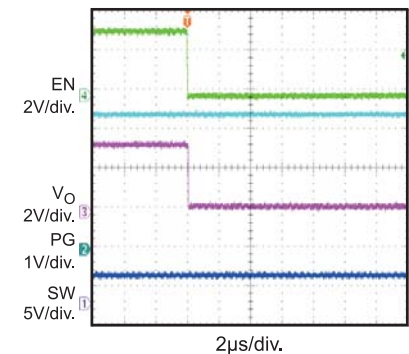

**PRINTED CIRCUIT BOARD LAYOUT**

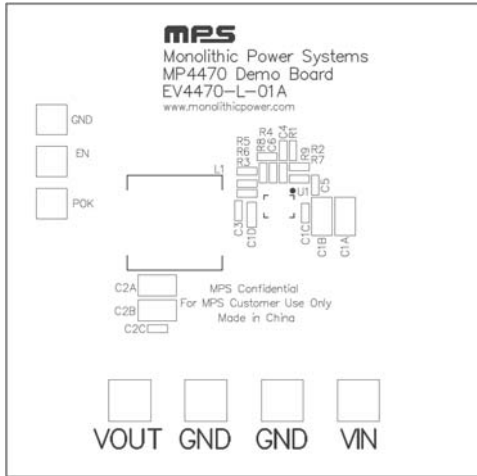

**Figure 1—Top Silk Layer**

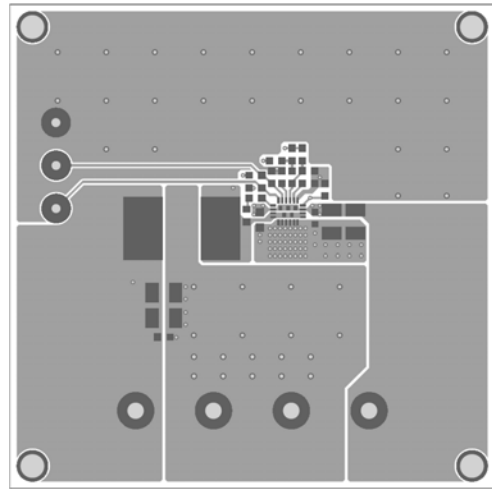

**Figure 2—Top Layer**

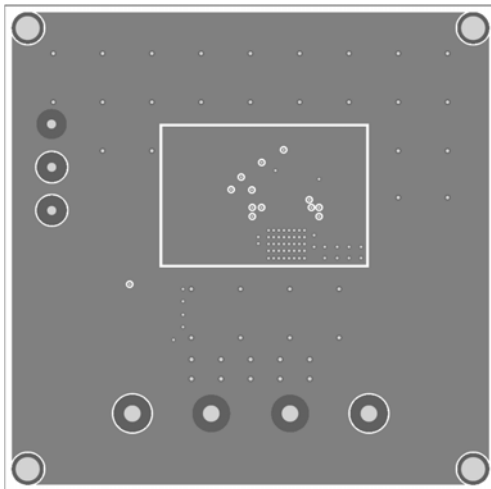

**Figure 3—Inner1 Layer**

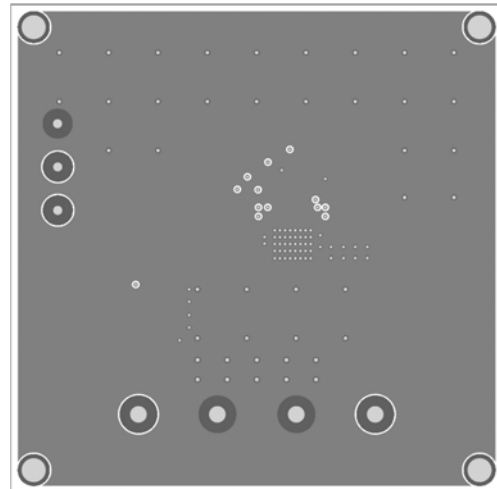

**Figure 4—Inner2 Layer**

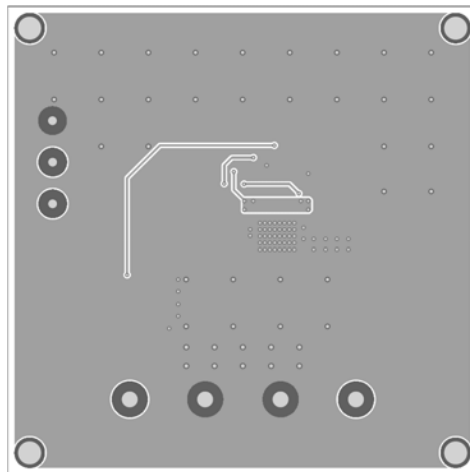

**Figure 5—Bottom Layer**

## QUICK START GUIDE

1. Connect the positive and negative terminals of the load to the VOUT and GND pins, respectively.
2. Preset the power supply output to between 4.5 and 36V, and then turn it off.
3. Connect the positive and negative terminals of the power supply output to the VIN and GND pins, respectively.
4. Turn the power supply on. The MPQ4470/4470AGL will automatically startup.
5. To use the Enable function, apply a digital input to the EN pin. Drive EN higher than 1.25V to turn on the regulator, drive EN less than 0.86V to turn it off.
6. An input under voltage lockout (UVLO) function is implemented by the addition of a resistor divider R5 and R8. The EN threshold is 0.86V (falling edge), so  $V_{IN}$  UVLO threshold is.  
$$0.86 \times \left(1 + \frac{R5}{R8}\right)$$
7. Use R1 and R2 to set the output voltage with  $V_{FB} = 0.815V$ . For  $R2 = 10k\Omega$ , R1 can be determined by:  $R1 = 12.27 \times (V_{OUT} - 0.815)$  (k $\Omega$ ). Follow the Application Information section in the device datasheet to recalculate the compensation, inductor and output capacitor values when output voltage is changed.

**NOTICE:** The information in this document is subject to change without notice. Users should warrant and guarantee that third party Intellectual Property rights are not infringed upon when integrating MPS products into any application. MPS will not assume any legal responsibility for any said applications.