

## DESCRIPTION

The EV44010-S-00B is a single stage offline evaluation board of MP44010 and MP26085 for 30W LED lighting driver.

MP44010 is a boundary conduction mode PFC controller which can provide simple and high performance active power factor correction using minimum external components.

MP26085 is a controller which can provide constant current control and over voltage protection.

The board involves LED dimming functions with two different options. One is PWM dimming and the other is 0-10V dimming.

The EV44010-S-00B can meet the Class C standard of IEC61000-3-2 and EN55015 standard.

## ELECTRICAL SPECIFICATIONS

Parameter	Symbol	Value	Units
Input AC Voltage	$V_{AC}$	85 to 265	V
Output current	$I_{OUT}$	700	mA
Output Power	$P_{OUT}$	30	W

## FEATURES

- Wide Operating Input Range(from 85V to 265V)
- Single Stage Offline LED Driver
- Meet Class C Standard of IEC61000-3-2
- Meet EN55015 Standard
- High Power Factor
- PWM Dimming and 0-10V Dimming Options
- Constant Current Control
- Over Voltage Protection

## APPLICATIONS

- Commercial LED lighting
- Automotive and Industry lighting
- Other LED lighting

For MPS green status, please visit MPS website under Quality Assurance. "MPS" and "The Future of Analog IC Technology", are Registered Trademarks of Monolithic Power Systems, Inc.



High Voltage

**Warning:** Although this board is designed to satisfy safety requirements, the engineering prototype has not been agency approved. Therefore, all testing should be performed using an isolation transformer to provide the AC input to the prototype board.

### EV44010-S-00B EVALUATION BOARD

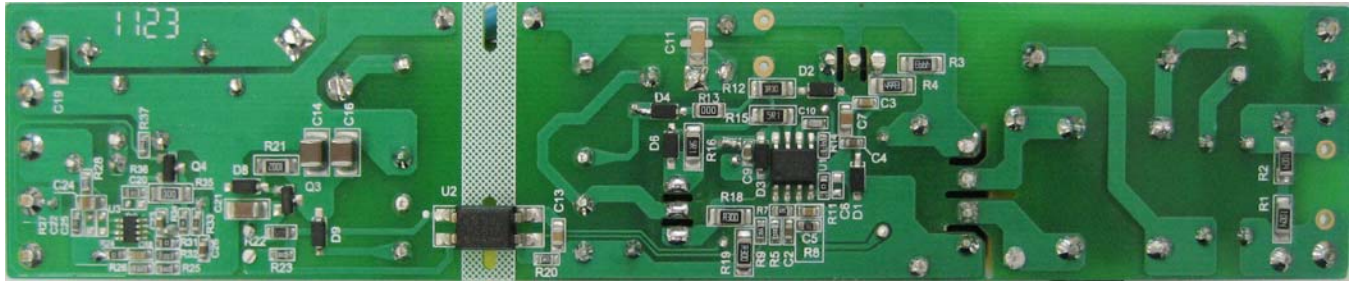

(L x W x H) (15cm x 3cm x 2.8cm)

Board Number	MPS IC Number
EV44010-S-00B	MP44010HS
	MP26085DJ

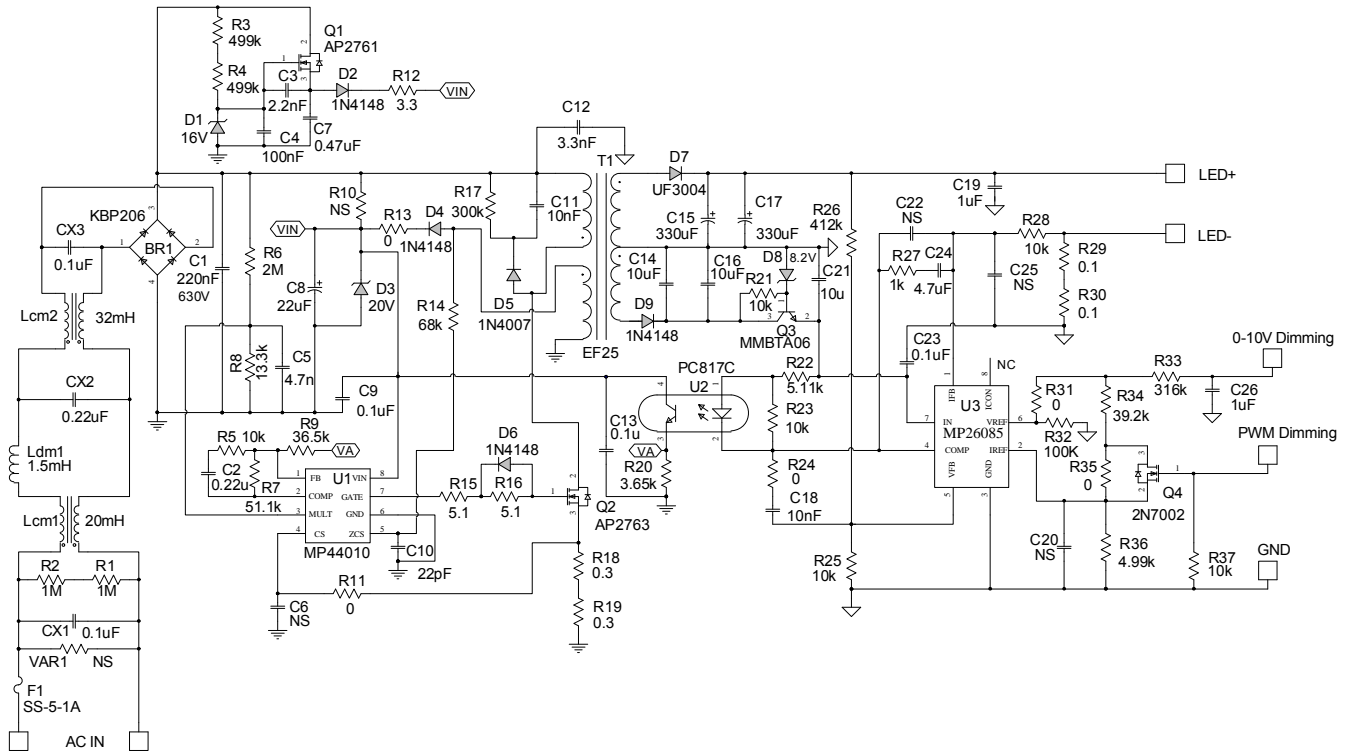
**EVALUATION BOARD SCHEMATIC**

**EV44010-S-00B BILL OF MATERIALS**

Qty	Ref	Value	Description	Package	Manufacturer	Part Number
0	VAR1	NS				
1	BR1	KBP206	600V/2A	DIP	any	KBP206
1	C1	220nF	CBB-CAP/630V	DIP	Panasonic	ECQE6224KF
1	C2	0.22µF	Ceramic Cap., 16V, X7R	603	muRata	GRM188R71C224KA01
1	C3	2.2nF	Ceramic Cap., 50V, X7R	603	muRata	GRM188R71H222KA0
3	C4,C9,C23	0.1µF	Ceramic Cap., 50V, X7R	603	muRata	GRM188R71H104KA0
1	C5	4.7nF	Ceramic Cap., 50V, X7R	603	muRata	GRM188R71H472KA0
0	C6, C20, C22, C25	NS				
1	C7	0.47µF	Ceramic Cap., 16V, X7R	805	TDK	C2012X7R1E474K
1	C8	22µF	Electrolytic Cap., 50V	DIP	Jianghai	CD281L-50V22
1	C10	22pF	Ceramic Cap., 50V, C0G	603	TDK	C1608C0G1H220J
1	C11	10nF	Ceramic Cap., 630V, X7R	1206	muRata	C3216X7R2J103K
1	C12	3.3nF	Y-Cap/4000V	DIP	HongKe	JYK10F332MY72N
1	C13	0.1µF	Ceramic Cap., 25V, X7R	805	muRata	GRM21BR71E104K
2	C14,C16	10µF	Ceramic Cap., 50V, X7R	1210	muRata	GRM32ER71H106K

**EV44010-S-00B BILL OF MATERIALS (continued)**

Qty	Ref	Value	Description	Package	Manufacturer	Part Number
2	C15,C17	330µF	Electrolytic Cap., 63V	DIP	Jianghai	CD263-63V330
1	C18	10nF	Ceramic Cap., 50V, X7R	603	muRata	GRM188R71H103KA0
1	C19	1µF	Ceramic Cap., 100V, X7R	1206	muRata	GRM31CR72A105KA
1	C21	10µF	Ceramic Cap., 16V, X7R	1206	TDK	C3216X7R1C106K
1	C24	4.7µF	Ceramic Cap., 16V, X7R	805	muRata	GRM21BR71C475K
1	C26	1µF	Ceramic Cap., 16V, X7R	603	TDK	C1608X7R1C105K
1	CX1	0.1µF	X-CAP/275V	DIP	Kaili	PX104K3ID19L270D
1	CX2	0.22µF	X-CAP/275V	DIP	Kaili	PX224K3ID49L270D
1	CX3	0.1µF	X-CAP/275V	DIP	Kaili	PX104K3ID19L270D
1	D1	BZT52C16	Diode, 16V/5mA	SOD-123	Diodes	BZT52C16
4	D2, D4, D6, D9	1N4148W	Diode, 75V/0.15A	SOD-123	Diodes	1N4148W
1	D3	BZT52C20	Diode, 20V/5mA	SOD-123	Diodes	BZT52C20
1	D5	1N4007	Diode	DIP	Diodes	1N4007
1	D7	UF3004	400V/3A	DIP	Diodes	UF3004
1	D8	BZT52C8V2	Diode, 8.2V/5mA	SOD-123	Diodes	BZT52C8V2
1	F1	Fuse	1A,250V	DIP	Cooper	SS-5-1A
1	Lcm1	20mH	Inductor	DIP	Würth	744821120
1	Lcm2	32mH	Inductor	DIP	Maotian	UT20-323LF
1	Ldm1	1.5mH	Inductor	DIP	TDK	TSL1112-152JR38
1	Q1	AP2761	650V	TO-220	APEC	AP2761
1	Q2	AP2763	750V	TO-220	APEC	AP2763
1	Q3	MMBTA06	80V	SOT-23	Diodes	MMBTA06
1	Q4	2N7002	MOSFET,60V	SOT-23	Vishay	2N7002-F
2	R1, R2	1M	Film Res., 1%	1206	Yageo	RC1206FR-071ML
2	R3,R4	499k	Film Res., 1%	1206	Panasonic	ERJ8ENF4993
4	R5, R25, R28, R37	10k	Film Res., 1%	603	Yageo	RC0603FR-0710KL
1	R6	2M	1/4 W	DIP	any	
1	R7	51.1k	Film Res., 1%	603	Yageo	RC0603FR-0751K1L
1	R8	13.3k	Film Res., 1%	603	Yageo	RC0603FR-0713K3L
1	R9	36.5k	Film Res., 1%	603	Yageo	RC0603FR-0736K5L
0	R10	NS				

**EV44010-S-00B BILL OF MATERIALS (continued)**

Qty	Ref	Value	Description	Package	Manufacturer	Part Number
3	R11, R24, R31	0	Film Res., 5%	603	Yageo	RC0603JR-070RL
1	R12	3.3	Film Res., 1%	1206	Royalohm	1206F330KT5E
2	R13, R35	0	Film Res., 5%	1206	Yageo	RC1206JR-070RL
1	R14	68k	Film Res., 1%	603	Yageo	RC0603FR-0768KL
2	R15, R16	5.1	Film Res., 5%	1206	Yageo	RC1206JR-075R1L
1	R17	300k	1W	DIP	any	
2	R18, R19	0.3	Film Res., 1%	1206	Yageo	RL1206FR-070R3L
1	R20	3.65k	Film Res., 1%	603	Yageo	RC0603FR-073K65L
1	R21	10k	Film Res., 1%	1206	Yageo	RC1206FR-0710KL
1	R22	5.11k	Film Res., 1%	805	Royalohm	0805F5111T5E
1	R23	10k	Film Res., 1%	603	Yageo	RC0603FR-0710KL
1	R26	412k	Film Res., 1%	603	Yageo	RC0603FR-07412KL
1	R27	1k	Film Res., 1%	603	Royalohm	0603F1001T5E
2	R29, R30	0.1	2W	DIP	any	
1	R32	100k	Film Res., 1%	603	Yageo	RC0603FR-07100KL
1	R33	316k	Film Res., 1%	603	Yageo	RC0603FR-07316KL
1	R34	39.2k	Film Res., 1%	603	Yageo	RC0603FR-0739K2L
1	R36	4.99k	Film Res., 1%	603	Yageo	RC0603FR-074K99L
1	T1	EE25	Transformer	DIP	Yimei	FX0210
1	U1	MP44010	PFC Controller	SO-8	MPS	MP44010
1	U2	PC817	Photocoupler	SMD	Sharp	PC817B
1	U3	MP26085	Offline charger controller	SOT23-8	MPS	MP26085

## EVB TEST RESULTS

Performance waveforms are tested on the evaluation board.

$V_{AC}=85V$  to  $265V$ , 14 LEDs in series for the load,  $I_{OUT}=700mA$ ,  $P_{OUT}=30W$ ,  $L_p=1.12mH$ .

**PF & THD vs.  $V_{AC}$**

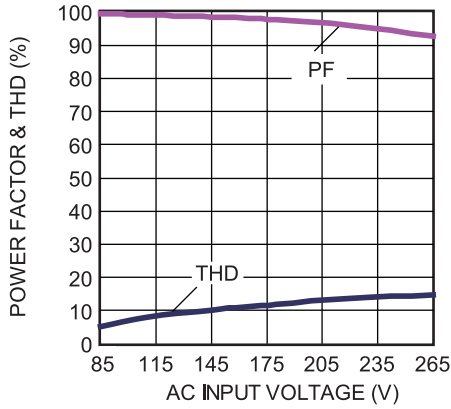

**Efficiency vs.  $V_{AC}$**

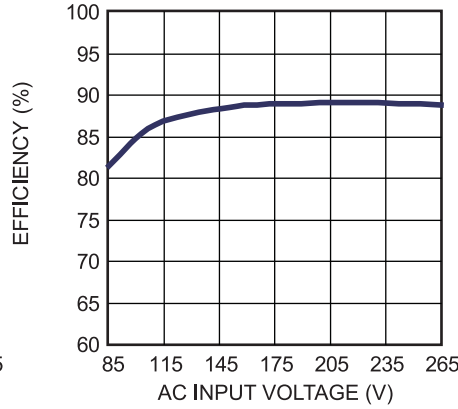

**Harmonic**

$V_{AC}=110V$ , full load

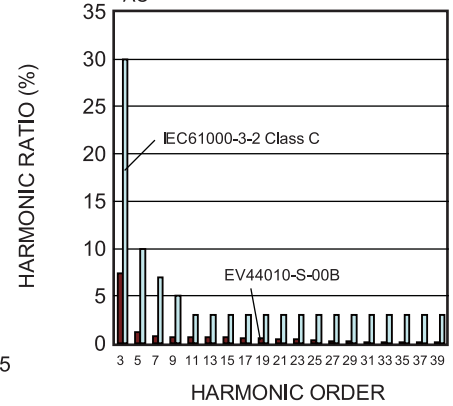

**Harmonic**

$V_{AC}=220V$ , full load

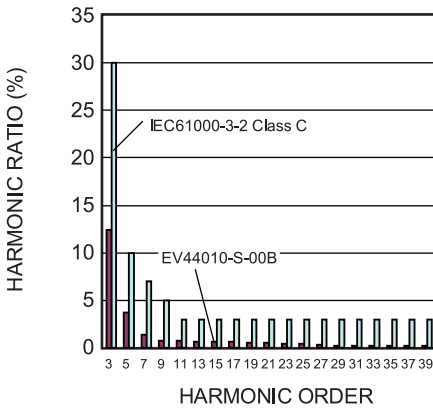

**Conducted EMI**

$V_{AC}=220V$ , full load

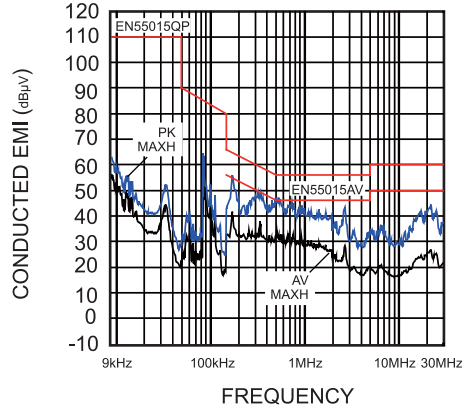

## EVB TEST RESULTS *(continued)*

Performance waveforms are tested on the evaluation board.

$V_{AC}=85V$  to  $265V$ , 14 LEDs in series for the load,  $I_{OUT}=700mA$ ,  $P_{OUT}=30W$ ,  $L_p=1.12mH$ .

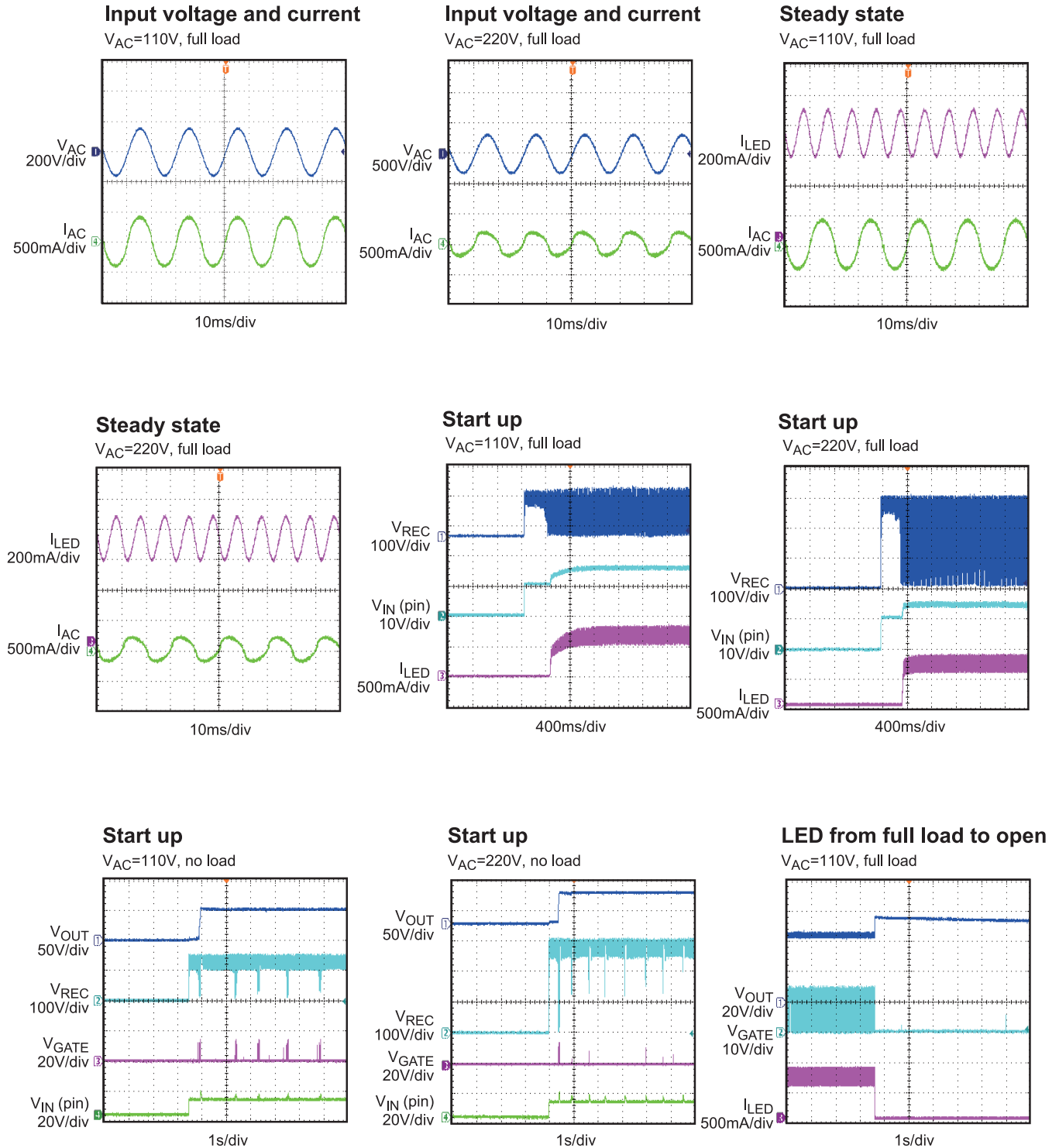

## EVB TEST RESULTS *(continued)*

Performance waveforms are tested on the evaluation board.

$V_{AC}=85V$  to  $265V$ , 14 LEDs in series for the load,  $I_{OUT}=700mA$ ,  $P_{OUT}=30W$ ,  $L_p=1.12mH$ .

**LED from full load to open**

$V_{AC}=220V$ , full load

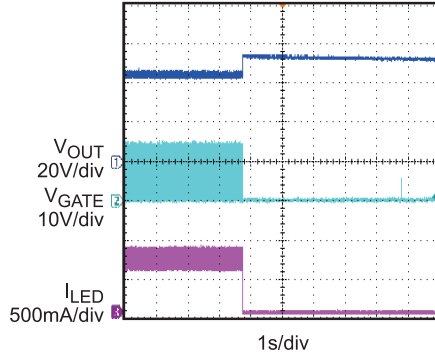

**LED from open to full load**

$V_{AC}=110V$ , full load

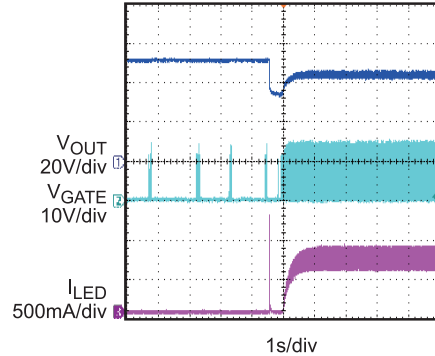

**LED from open to full load**

$V_{AC}=220V$ , full load

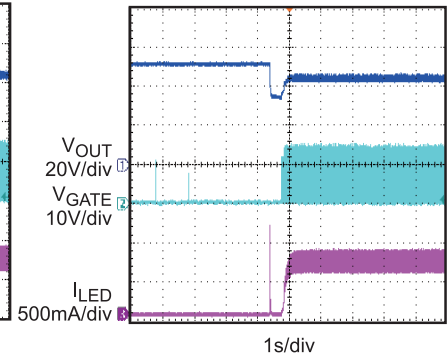

**SCP entry, LED+ short to LED-**

$V_{AC}=110V$ , full load

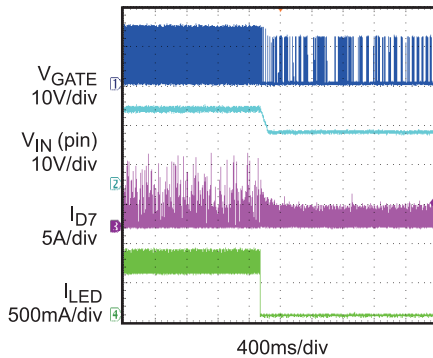

**SCP entry, LED+ short to LED-**

$V_{AC}=220V$ , full load

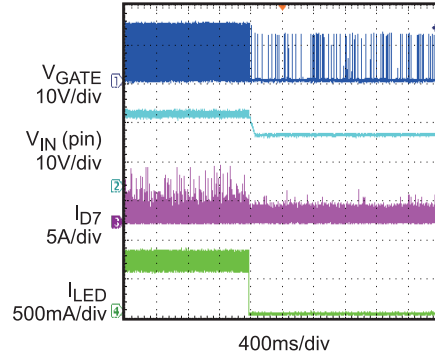

**SCP steady state, LED+ short to LED-**

$V_{AC}=110V$

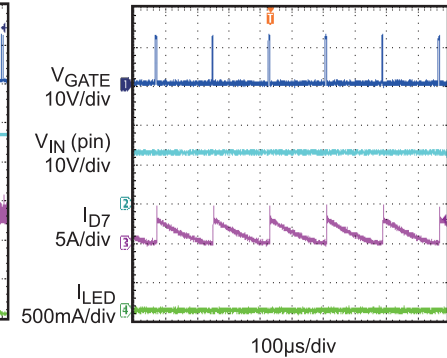

**SCP steady state, LED+ short to LED-**

$V_{AC}=220V$

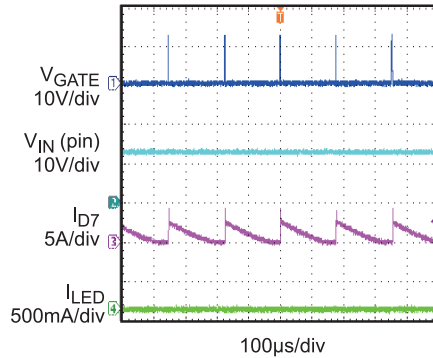

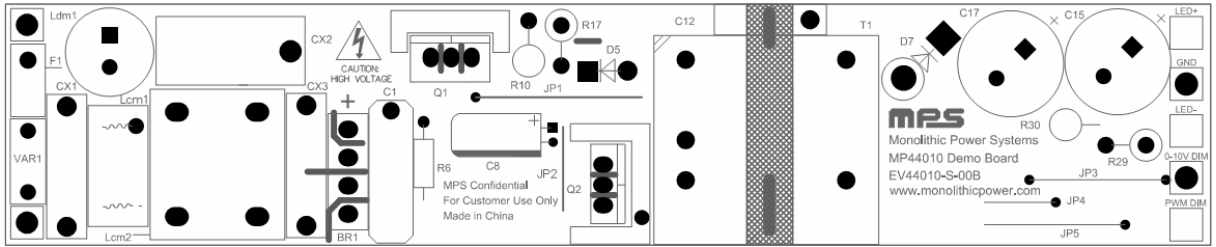
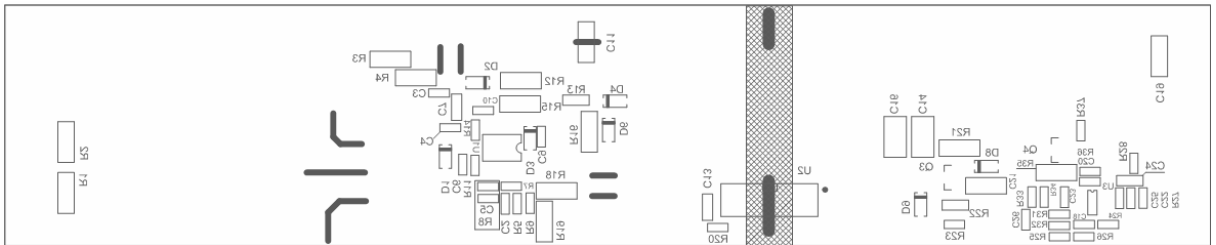
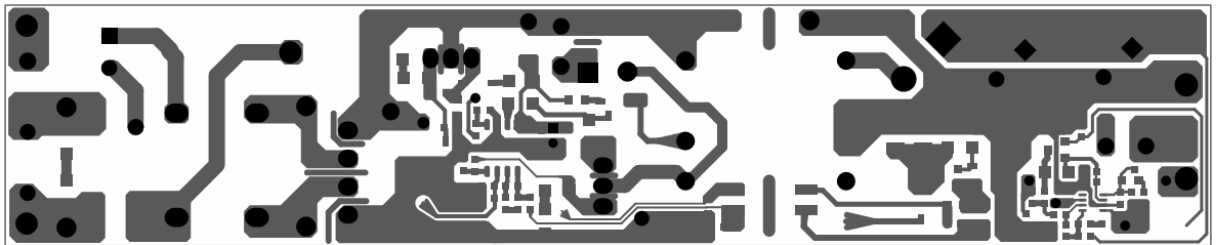

**PRINTED CIRCUIT BOARD LAYOUT**

**Figure 1—Top Silk Layer**

**Figure 2—Bottom Silk Layer**

**Figure 3—Bottom Layer**

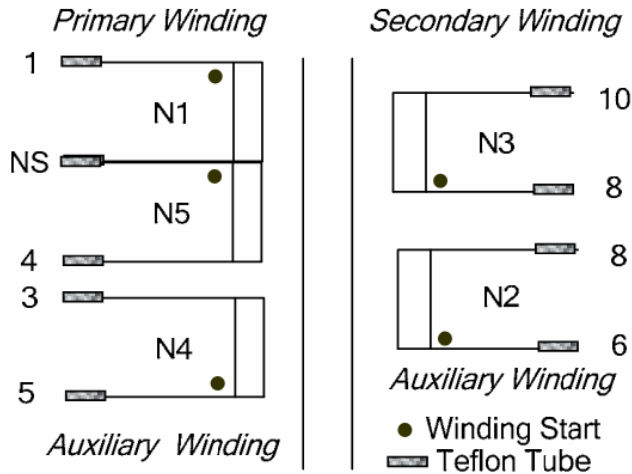
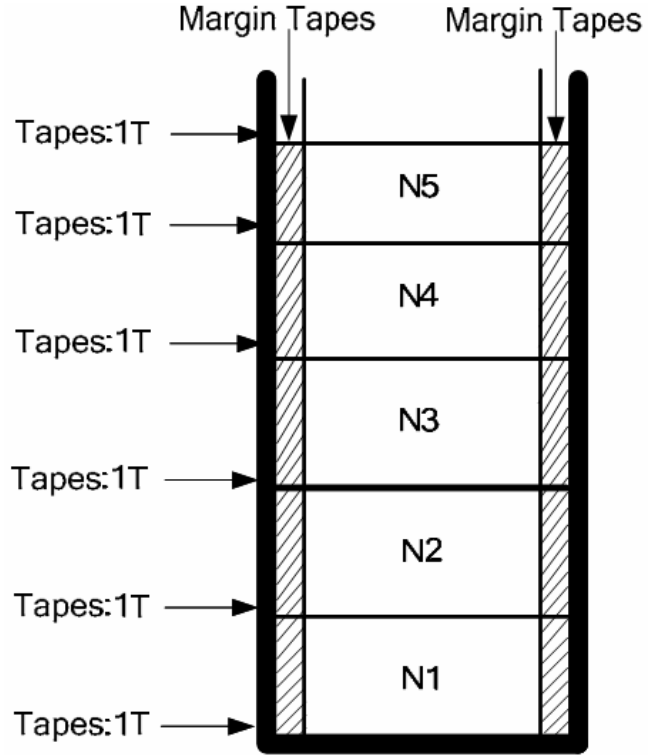
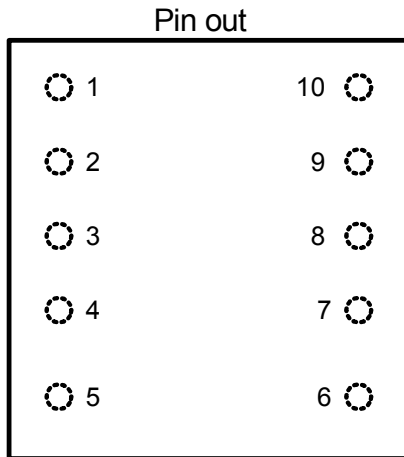
## QUICK START GUIDE

1. Preset AC input voltage between 85V and 265V. Then turn off AC power supply.
2. Connect the LED string to the LED+ and LED- pins.
3. Connect the Line and Neutral terminals of the power supply output to AC input.
4. Turn the power supply on. The board will automatically startup.
5. The LED dimming function is available with two options (PWM dimming & 0-10V dimming). For PWM option, R31=0 $\Omega$  and R35 is NS; apply a square voltage ( $V_H=5V$ ,  $V_L=0V$ , Duty=50%) to the pillars of PWM DIM and GND. For 0-10V option, R35=0 $\Omega$  and R31 is NS; apply a DC voltage (0-10V) to the pillars of 0-10V DIM and GND.

## APPENDIX: TRANSFORMER SPECIFICATION

**Electrical Diagram**

**Winding Diagram**

**Pin Definition of Bobbin**

View from the top

**Table 1—Electrical Characteristic**

Parameter	Condition	Value
Primary Inductance	Lp(4-1)	1.12mH±5%
Core		EF25
Bobbin		EF25
Core Material		DMR40 or equivalent
Turn Ratio	N1:N2:N3:N4:N5	55:10:27:9:55

**Table 2—Winding Specification**

Tape Turns	Winding No.	Margin Tapes	Start & End	Wire Diameter (mm)	Turns
1	N1	2mm	1→NS	0.33×1	55
1	N2	2mm	6→8	0.18×1	10
1	N3	2mm	8→10	0.33×2	27
1	N4	2mm	5→3	0.18×1	9
1	N5	2mm	NS→4	0.33×1	55

**NOTICE:** The information in this document is subject to change without notice. Users should warrant and guarantee that third party Intellectual Property rights are not infringed upon when integrating MPS products into any application. MPS will not assume any legal responsibility for any said applications.