



The Future of Analog IC Technology®

EV4050A-J-00A

Universal Input, 40V/115mA Off-line Non-isolated LED Driver Evaluation Board

DESCRIPTION

The MP4050A is a constant current LED driver with an integrated 500V MOSFET. It is designed specifically for energy efficient and low-cost LED bulb replacement applications.

The EV4050A-J-00A Evaluation Board is designed to demonstrate the capabilities of MP4050A as an off-line, non-isolated LED driver which can load 40V/115mA LEDs in universal input voltage (85VAC to 265VAC, 50Hz/60Hz).

The EV4050A-J-00A has an excellent efficiency and meets IEC61000-4-5 surge immunity and EN55015 conducted EMI requirements. It has various protections, like integrated thermal current foldback, VCC under-voltage lockout (UVLO), open LED protection (OLP), short-circuit protection (SCP), and over-temperature protection (OTP). All of these features make MP4050A an ideal solution for simple, off-line and non-isolated LED applications.

ELECTRICAL SPECIFICATION

| Parameter | Symbol | Value | Units |
|----------------|-----------|-----------|-------|
| Input Voltage | V_{IN} | 85 to 265 | VAC |
| Output Voltage | V_{OUT} | 40 | V |
| Output Current | I_{OUT} | 115 | mA |
| Efficiency | η | >85 | % |

FEATURES

- Constant Current LED Driver
- Integrated 500V/8Ω MOSFET
- Low VCC Operating Current
- Maximum Frequency Limit
- Audible Noise Restrain
- Internal High-Voltage Current Source
- Internal 200ns Leading Edge Blanking
- Integrated Thermal Current Foldback
- Thermal Shutdown (Auto Restart with Hysteresis)
- VCC Under Voltage Lockout with Hysteresis
- Open LED Protection
- Short Circuit Protection
- Auto-Restart Function

APPLICATIONS

- AC/DC or DC/DC LED driver application
- General Illumination
- Industrial Lighting
- Automotive/Decorative LED Lighting

All MPS parts are lead-free and adhere to the RoHS directive. For MPS green status, please visit MPS website under Quality Assurance. "MPS" and "The Future of Analog IC Technology", are Registered Trademarks of Monolithic Power Systems, Inc.



High Voltage

Warning: Although this board is designed to satisfy safety requirements, the engineering prototype has not been agency approved. Therefore, all testing should be performed using an isolation transformer to provide the AC input to the prototype board.

EV4050A-J-00A EVALUATION BOARD



TOP VIEW

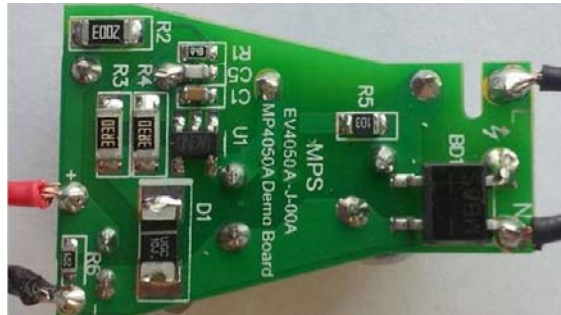

BOTTOM VIEW

(L x W x H) 29mm x 19mm x 18mm

| | |
|---------------------|----------------------|
| Board Number | MPS IC Number |
| EV4050A-J-00A | MP4050AGJ |

EVALUATION BOARD SCHEMATIC

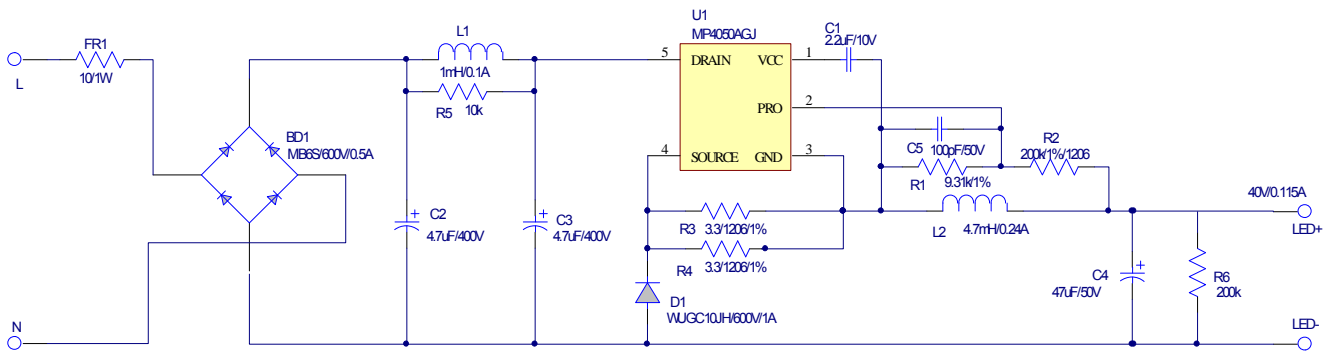

Figure 1—Schematic

PCB LAYOUT (SINGLE-SIDED)

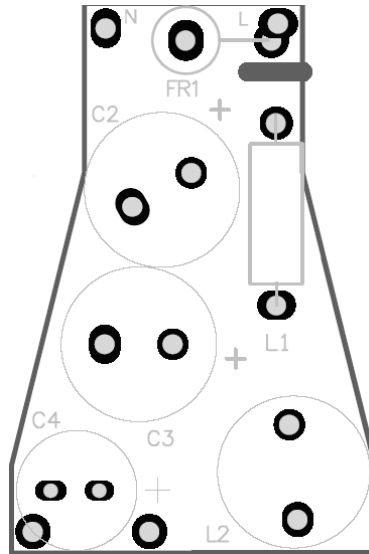

Figure 2—Top Layer

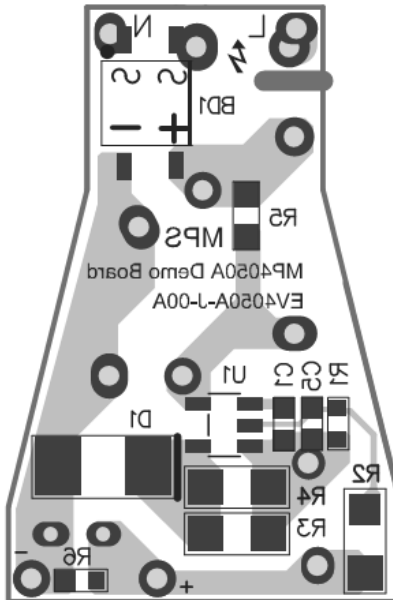

Figure 3—Bottom Layer

CIRCUIT DESCRIPTION

The EV4050A-J-00A is configured to deliver a constant 115mA current at an output voltage of 40VDC. The EVB is designed for driving LEDs with a constant current (CC) in high-side buck topology. The simplicity and low component count of EV4050A-J-00A make the demo board ideal for space constrained and cost sensitive application such as GU10 size lamps.

FR1 and BD1 compose the input stage. FR1 is used to protect for the component failure or some excessive short events, also it can restrain the inrush current.

C2 L1 and C3 compose π filter to guarantee the conducted EMI meet standard EN55015. C2 and C3 are also used for energy storage reducing line noise and protecting against line surge. R5 is an optional parallel resistor on the board across L1 which damps the resonance of the π filter.

C1 is the VCC supply capacitor which should be located near as IC and such as several μ F is enough.

R3, R4 are the sense resistor with 1% tolerance for good output current precision. It's also recommended to use $\pm 400\text{PPM}/^\circ\text{C}$ temperature coefficient type for better output current regulation in high temperature and low temperature.

C5 is decoupling cap to decouple the voltage noise spike in high side buck solution. Around 100pF is suggested to use for stable operation.

D1 is the freewheeling diode with ultrafast type. The recovery time of $<75\text{ns}$ should be used which slow diodes cause excessive leading edge current spike during start-up and affect the efficiency. Ultrafast ($t_{\text{r}} < 75\text{ns}$) diode such as WUGC10JH or EGC10GH are recommended.

R1 and R2 are the divided resistors which detect the output voltage for fault protection. It's suggested to use the 1% tolerance. The upper divided resistor R2 is recommended to have a minimum size of SMD 1206 package. The PRO pin time constant should be less than 1us which is related with R1 and R2 value.

L2 is the power inductor which could use the low cost drum core. However, drum core have the open magnetic path which can be shored by a metal enclosure which reduces the effective inductance and requires the value to be adjusted to take this into account when placed inside the final enclosure.

C4 is the output filter capacitor which is to smooth the inductor current and limit the output current ripple and ensure high frequency current flow within as small as a loop area as possible to reduce EMI. 105°C or above rated capacitor should be choose in small size application for long life.

The dummy load R6 is used to regulator the output voltage within the designed value in open lamp protection.

EV4050A-J-00A BILL OF MATERIALS

| Qty | Ref | Value | Description | Package | Manufacturer | Manufacturer_P/N |
|-----|-----------|----------------|--------------------------------|----------|-------------------------|--------------------|
| 1 | C1 | 2.2 μ F | Ceramic Capacitor, 10V, X7R | 0603 | muRata | GRM188R71A225KE15D |
| 2 | C2, C3 | 4.7 μ F | Capacitor;400V;20% | DIP | Beryl | 4.7 μ F/400V |
| 1 | C4 | 47 μ F | Capacitor;50V;20% | DIP | Jianghai | CD263-50V47 |
| 1 | C5 | 100pF | Ceramic Capacitor, 50V, C0G | 0603 | muRata | GRM1885C1H101JA01D |
| 1 | BD1 | MB6S | Diode;600V;0.5A | SOIC-4 | Taiwan Semiconductor | MB6S |
| 1 | D1 | WUGC10JH | Diode;600V;1A | SMA | Diodes | WUGC10JH |
| 1 | FR1 | 10 Ω | Resistor;5%;1W | DIP | Yageo | FKN1WSJT-52-10R |
| 1 | L1 | 1mH | Inductor;100mA | DIP | Bangdayuan | CKL0510-102 |
| 1 | L2 | 4.7mH | Inductor;240mA | DIP | Würth | 7447724472 |
| 1 | R1 | 9.31k Ω | Film Resistor;1% | 0603 | Yageo | RC0603FR-079K31L |
| 1 | R2 | 200k Ω | Film Resistor;1% | 1206 | Yageo | RC1206FR-07200KL |
| 2 | R3, R4 | 3.3 Ω | Film Resistor;1% | 1206 | Yageo | RC1206FR-073R3L |
| 1 | R5 | 10k Ω | Film Resistor;5% | 0805 | Yageo | RC0805JR-0710KL |
| 1 | R6 | 200k Ω | Film Resistor;5% | 0603 | Yageo | RC0603JR-07200KL |
| 1 | U1 | MP4050AGJ | Constant Current LED Driver | TSOT23-5 | MPS | MP4050AGJ-Z |

EVB TEST RESULTS

Performance Data

T_A=+25°C, unless otherwise noted.

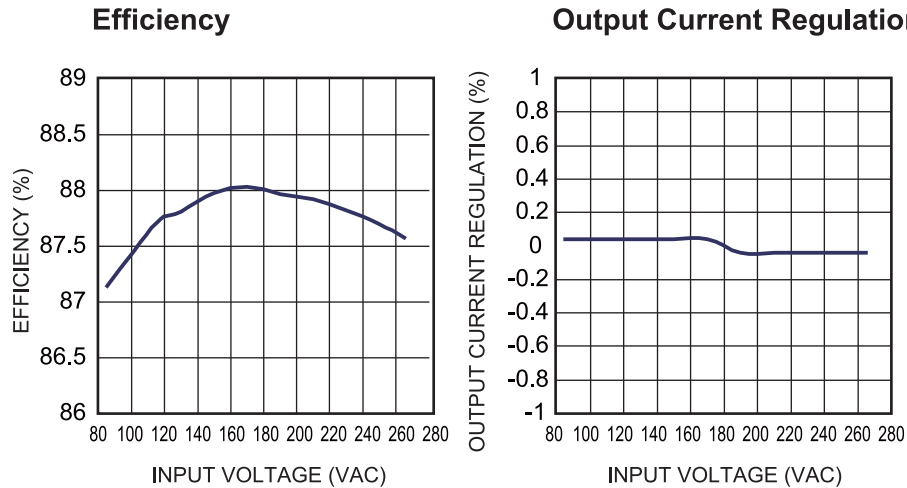

Surge Test

Line to Line 1kV surge testing is completed according to IEC61000-4-5.

Input voltage is 220VAC/50Hz and operation is verified as following each surge event.

| Surge Level (V) | Input Voltage (VAC) | Injection Location | Injection Phase (°) | Test Result (Pass/Fail) |
|-----------------|---------------------|--------------------|---------------------|-------------------------|
| 1000 | 220 | L to N | 0 | Pass |
| -1000 | 220 | L to N | 0 | Pass |
| 1000 | 220 | L to N | 90 | Pass |
| -1000 | 220 | L to N | 90 | Pass |
| 1000 | 220 | L to N | 180 | Pass |
| -1000 | 220 | L to N | 180 | Pass |
| 1000 | 220 | L to N | 270 | Pass |
| -1000 | 220 | L to N | 270 | Pass |

Conducted EMI Test

EV4050A-J-00A comply the EN55015 requirement.

Conducted EMI
115VAC/60Hz, Line Wire

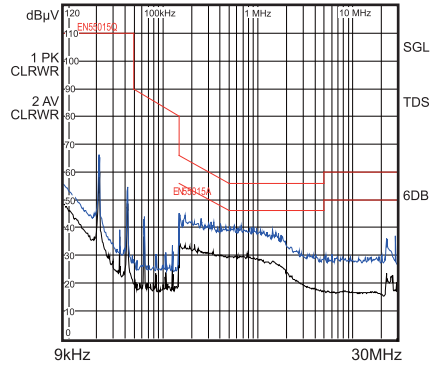

Conducted EMI
115VAC/60Hz, Neutral Wire

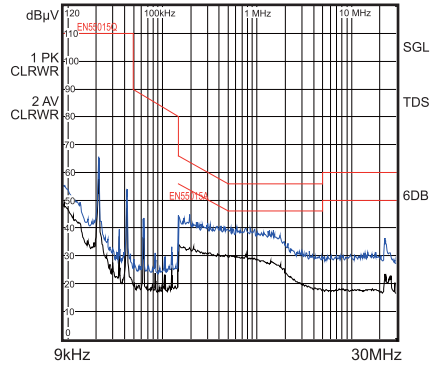

Conducted EMI
230VAC/50Hz, Line Wire

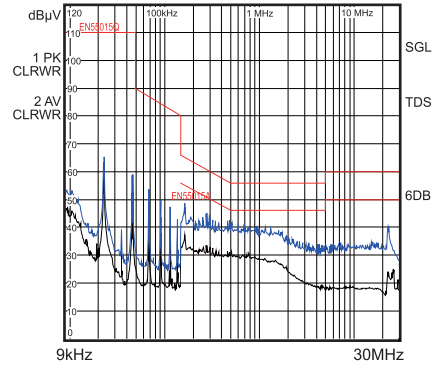

Conducted EMI
230VAC/50Hz, Neutral Wire

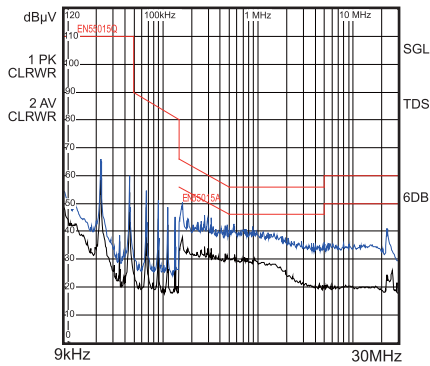

EVB TEST RESULTS

Performance waveforms are tested on the evaluation board.

$V_{IN}=115VAC/60Hz$, $V_{OUT}=40V$, $I_{LED}=115mA$, $T_A=25^{\circ}C$, unless otherwise noted.

Steady State

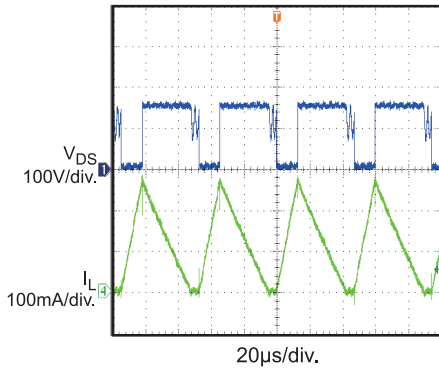

Output Current Ripple

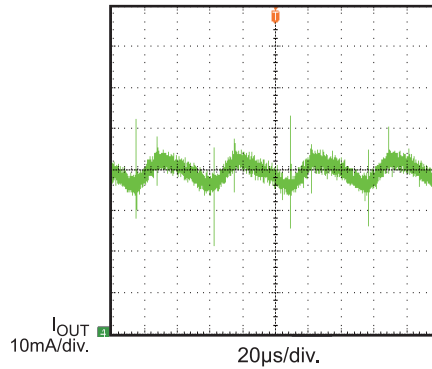

Soft Start

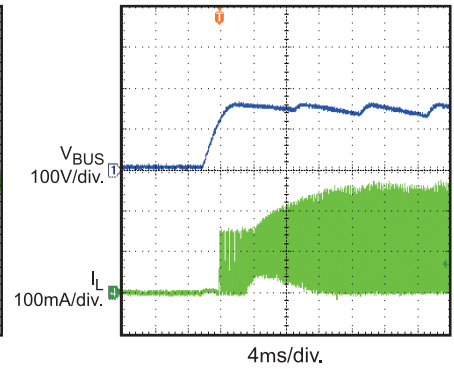

Turn On Delay

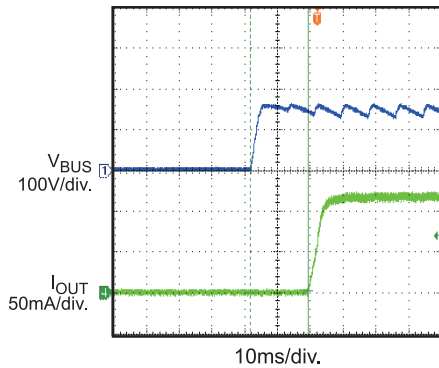

Shutdown

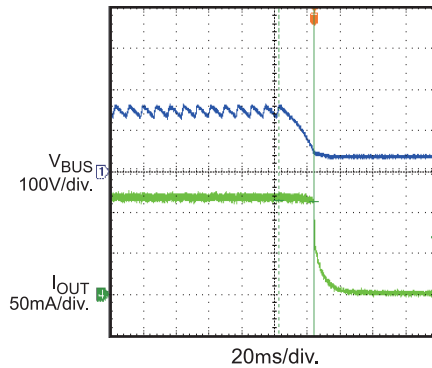

Short Circuit Protection

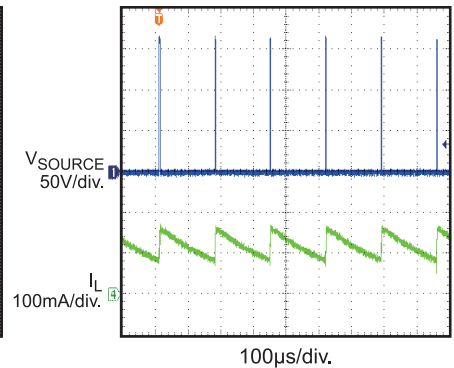

Short Circuit Protection Entry & Recovery

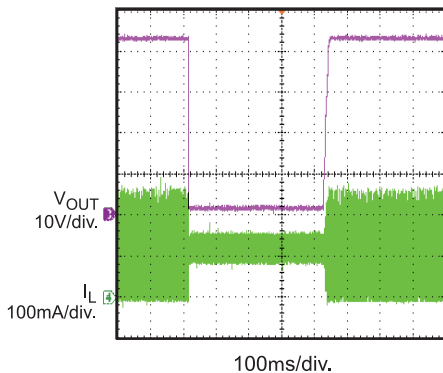

Open LED Protection Entry

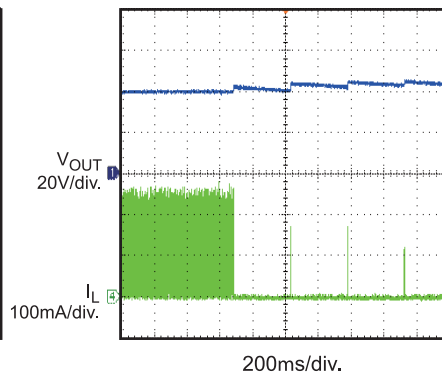

Open LED Protection Recovery

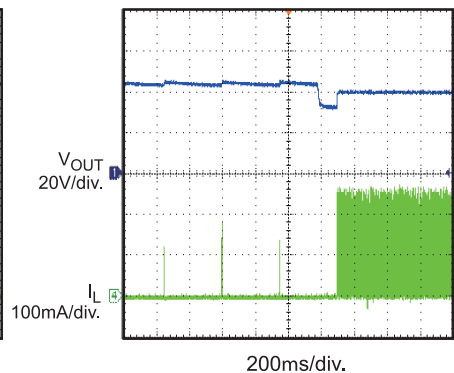

EVB TEST RESULTS (continued)

Performance waveforms are tested on the evaluation board.

 $V_{IN}=230VAC/50Hz$, $V_{OUT}=40V$, $I_{LED}=115mA$, $T_A=25^{\circ}C$, unless otherwise noted.

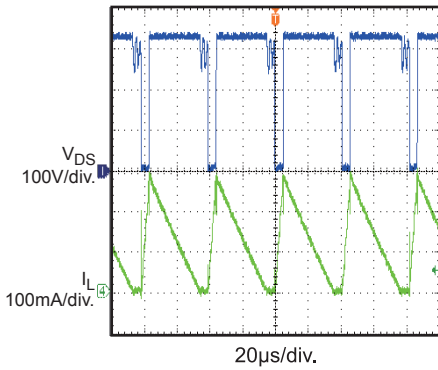
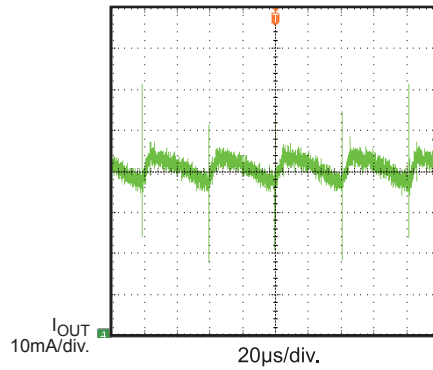
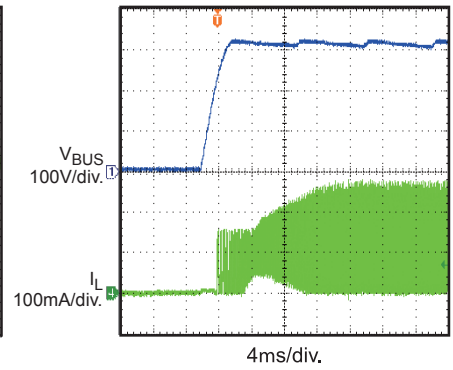
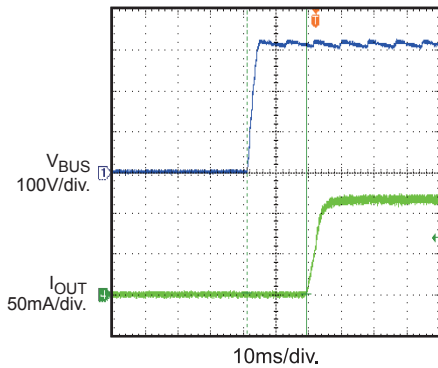
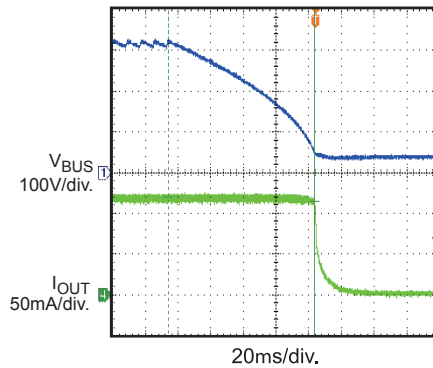
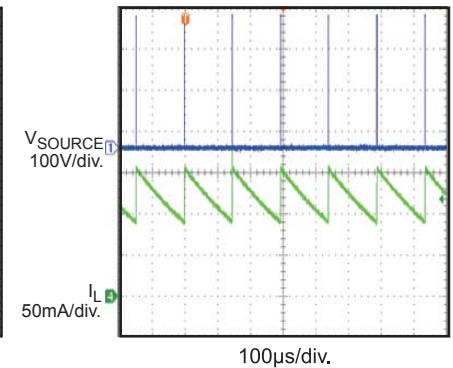
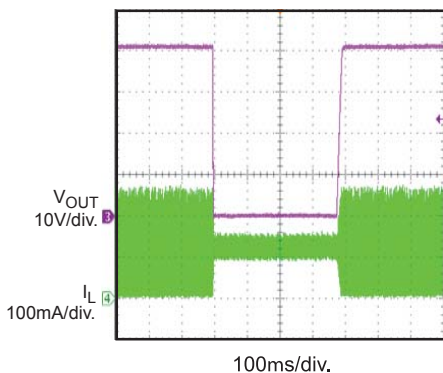
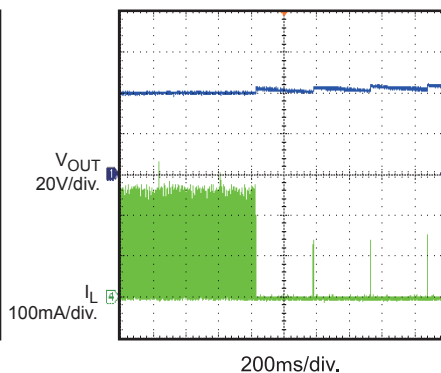
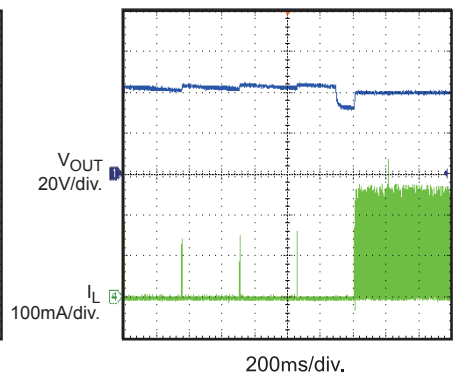
Steady State

Output Current Ripple

Soft Start

Turn On Delay

Shutdown

Short Circuit Protection

Short Circuit Protection Entry & Recovery

Open LED Protection Entry

Open LED Protection Recovery

QUICK START GUIDE

1. Preset Power Supply to $85\text{VAC} \leq V_{\text{IN}} \leq 265\text{VAC}$.
2. Turn Power Supply off.
3. Connect the Line and Neutral terminals of the power supply output to L and N port. For three-wire input application, make LED- connected to Earth.
4. Connect Load to:
 - a. Positive (+): LED+
 - b. Negative (-): LED-
5. Turn Power Supply on after making connections.

NOTICE: The information in this document is subject to change without notice. Please contact MPS for current specifications. Users should warrant and guarantee that third party Intellectual Property rights are not infringed upon when integrating MPS products into any application. MPS will not assume any legal responsibility for any said applications.