



The Future of Analog IC Technology®

# EV4034-S-00C

85VAC~265VAC/50Hz, 40V/150mA

Non-Isolation Off-line LED Driver Evaluation Board

## DESCRIPTION

The EV4034-S-00C Evaluation Board is designed to demonstrate the capabilities of MP4034. The MP4034 can be used for non-isolated LED lighting controller.

The EV4034-S-00C typically drives a 6W LED string with a 40V<sub>TYP</sub>, 150mA LED load from 85VAC to 265VAC, at 50Hz.

The EV4034-S-00C has excellent efficiency and meets IEC61547 surge immunity and EN55015 conducted EMI requirements. It has multiple protections, including lamp open protection, short-circuit protection, a cycle-by-cycle current limit, and over-temperature protection.

## ELECTRICAL SPECIFICATION

Parameter	Symbol	Value	Units
Input Voltage	V <sub>IN</sub>	85 to 265	VAC
Output Voltage	V <sub>OUT</sub>	40	V
LED Current	I <sub>LED</sub>	150	mA
Output Power	P <sub>OUT</sub>	6.0	W
Efficiency (full load)	η	>80	%

## FEATURES

- No External Compensation Components
- Precise Constant Current (CC)
- Integrated 700V MOSFET with Minimal External Components
- Variable Off-Time Peak-Current Control
- 600µA High-Voltage Current Source
- Up to 6W Output Power
- Over-Voltage Protection (OVP)
- Over-Temperature Protection (OTP)
- Lamp Open Protection
- Natural Frequency Dithering for Improved EMI Signature
- Low Cost and Simple External circuit
- Fits GU10 LED

## APPLICATIONS

- Solid-State Lighting
- Industrial & Commercial Lighting
- Residential Lighting

All MPS parts are lead-free and adhere to the RoHS directive. For MPS green status, please visit MPS website under Quality Assurance. "MPS" and "The Future of Analog IC Technology", are Registered Trademarks of Monolithic Power Systems, Inc.



**Warning:** Although this board is designed to satisfy safety requirements, the engineering prototype has not been agency approved. Therefore, all testing should be performed using an isolation transformer to provide the AC input to the prototype board.

**EV4034-S-00C EVALUATION BOARD**

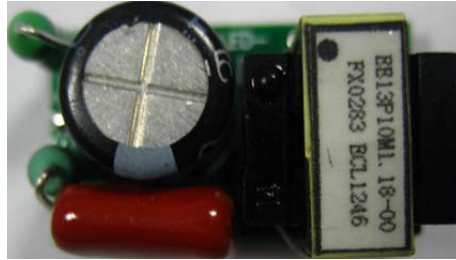

**TOP VIEW**

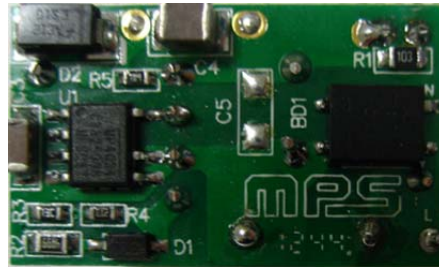

**BOTTOM VIEW**

(L x W x H) 27mm x 16mm x 16mm

Board Number	MPS IC Number
EV4034-S-00C	MP4034GS

EVALUATION BOARD SCHEMATIC

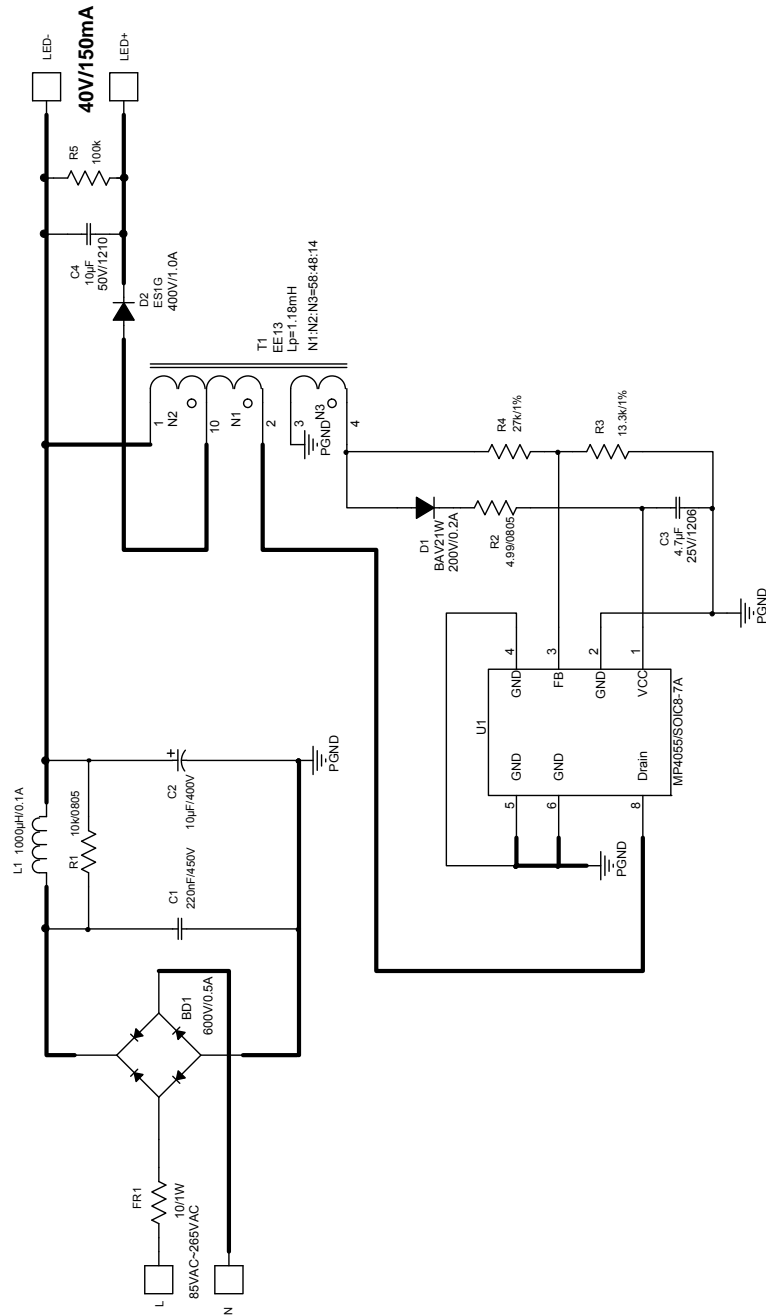
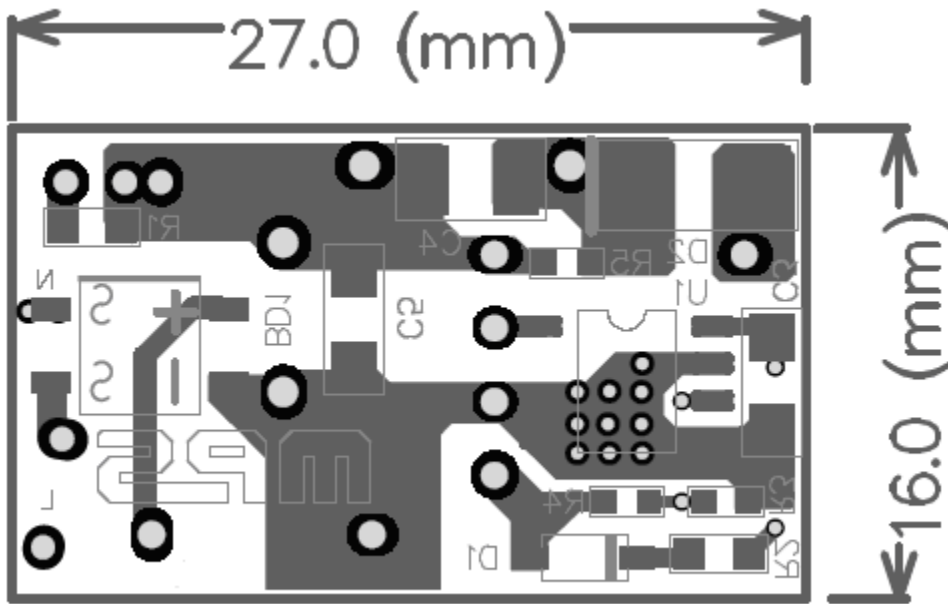
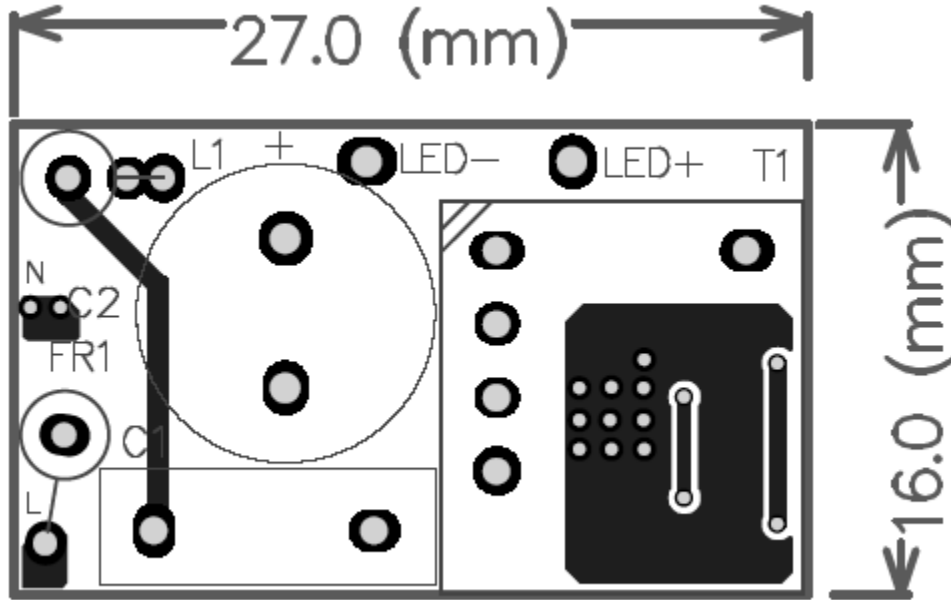

Figure 1—Schematic

**PCB LAYOUT (SINGLE-SIDED)**



## CIRCUIT DESCRIPTION

The EV4034-S-00C is configured for non-isolation control topology, It can simplify the schematic and reduce BOM costs. It can also achieve an accurate LED current.

The input stage consists of FR1 and BD1. FR1 is protects against component failure or some excessive short events, and can restrain the inrush current.

The  $\pi$  filter (C1, L1 and C2) guarantees that the conducted EMI meets the EN55015 standard.

R2, C3 and D1 provide the VCC power supply.

The resistor divider (R3 and R4) provides lamp open protection by sampling the voltage on the auxiliary winding. When an open circuit occurs, the output voltage remains constant.

T1 is the power transformer, the structure of which is also very important to pass EMI test.

D2, C4 and R5 compose output circuit. D2 is a schottky diode for better efficiency. C4 is a ceramic capacitor for lower output voltage ripple and R5 is the dummy load for lamp open protection.

**EV4034-S-00C BILL OF MATERIALS**

Qty	RefDes	Value	Description	Package	Manufacturer	Manufacturer_PN
1	BD1	MB6F	Diode;600V;0.5A	SOP-4	Bangdayuan	MB6F
1	C1	220nF	Capacitor;450V;CBB	DIP	Carli	TF224K2Y109L270D9R
1	C2	10 $\mu$ F	Electrolytic Capacitor; 400V	DIP	LiLong	RGA100M2G
1	C3	4.7 $\mu$ F	Ceramic Capacitor; 25V;X7R	1206	TDK	C3216X7R1E475K
1	C4	10 $\mu$ F	Ceramic Capacitor; 50V;X7R	1210	muRata	GRM32ER71H106KA12L
1	D1	BAV21W	Diode;200V;0.2A	SOD-123	Diodes	BAV21W-7-F
1	D2	ES1G	Diode;400;1A	SMA	Taiwan Semiconductor	ES1G
1	FR1	10 $\Omega$	Resistor;5%;1W	DIP	Yageo	FKN1WSJT-52-10R
1	L1	1000 $\mu$ H	Inductor;1000 $\mu$ H; 0.1A	DIP	Bangdayuan	CKL0410-102
1	R1	10k $\Omega$	Film Resistor;1%	0805	Yageo	RC0805FR-0710KL
1	R2	4.99 $\Omega$	Film Resistor;1%	0805	Yageo	RC0805FR-074R99L
1	R3	13.3k $\Omega$	Film Resistor;1%	0603	Yageo	RC0603FR-0713K3L
1	R4	27k $\Omega$	Film Resistor;1%	0603	Yageo	RC0603FR-0727KL
1	R5	100k $\Omega$	Film Resistor;5%	0603	Yageo	CR03T05NJ100K
1	T1	1.18mH	EE13; N1:N2:N3=58:48:14	DIP	Emei	FX0283
1	U1	MP4034	Primary-Side Regulator	SOIC8-7A	MPS	MP4034GS

### TRANSFORMER SPECIFICATION

#### Electrical Diagram

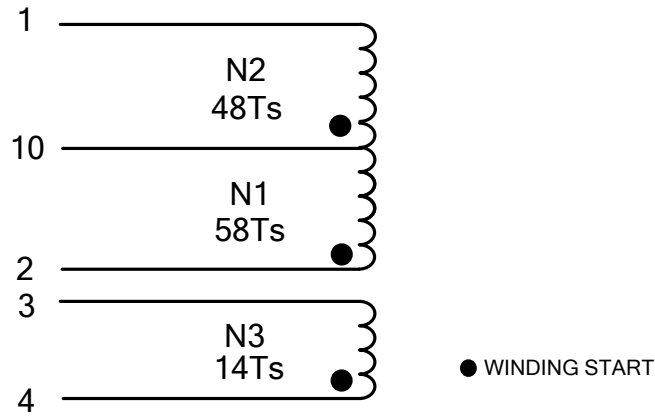

Figure 4—Transformer Electrical Diagram

#### Winding Diagram

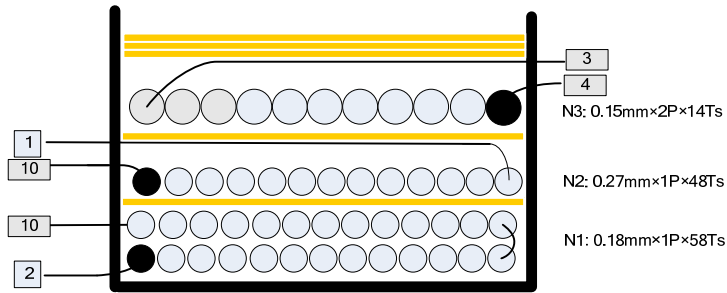

Figure 5—Winding Diagram

**Winding Order**

Winding No.	Tape Layer Number	Start & End	Magnet Wire $\Phi$ (mm)	Turns
N1	1	2→10	0.18mm * 1	58
N2	1	10→1	0.27mm * 1	48
N3	3	4→3	0.15mm * 2	14

**Materials**

Item	Description
1	Core: EE13, UI=2500±25%, AL=105nH/N <sup>2</sup> ±3% GAPPED, ACME P4 or equivalent
2	Bobbin: EE13, 5+5PIN 1 SECT TH, UL94V-0
3	Wire: $\Phi$ 0.15mm, 2UEW, Class B
4	Wire: $\Phi$ 0.18mm, 2UEW, Class B
5	Wire: $\Phi$ 0.27mm, 2UEW, Class B
5	Tape: 6.0mm(W)×0.06mm(TH)
6	Tape: 8.0mm(W)×0.06mm(TH)
7	Varnish: JOHN C. DOLPH CO, BC-346A or equivalent
8	Solder Bar: CHEN NAN: SN99.5/Cu0.5 or equivalent



## EVB TEST RESULTS

### Performance Data

#### Efficiency

$f$ (Hz)	Vin (VAC)	Pin (W)	Vout (V)	Iout (mA)	Pout (W)	Efficiency (%)
60	85	7.01	38.6	148	5.71	81.49
	115	6.75	38.6	149	5.75	85.21
	150	6.76	38.6	150	5.79	85.65
50	180	6.71	38.6	151	5.83	86.86
	210	6.74	38.6	152	5.87	87.05
	230	6.77	38.6	153	5.91	87.23
	265	6.91	38.6	154	5.94	86.03

Efficiency vs. Input Line Voltage

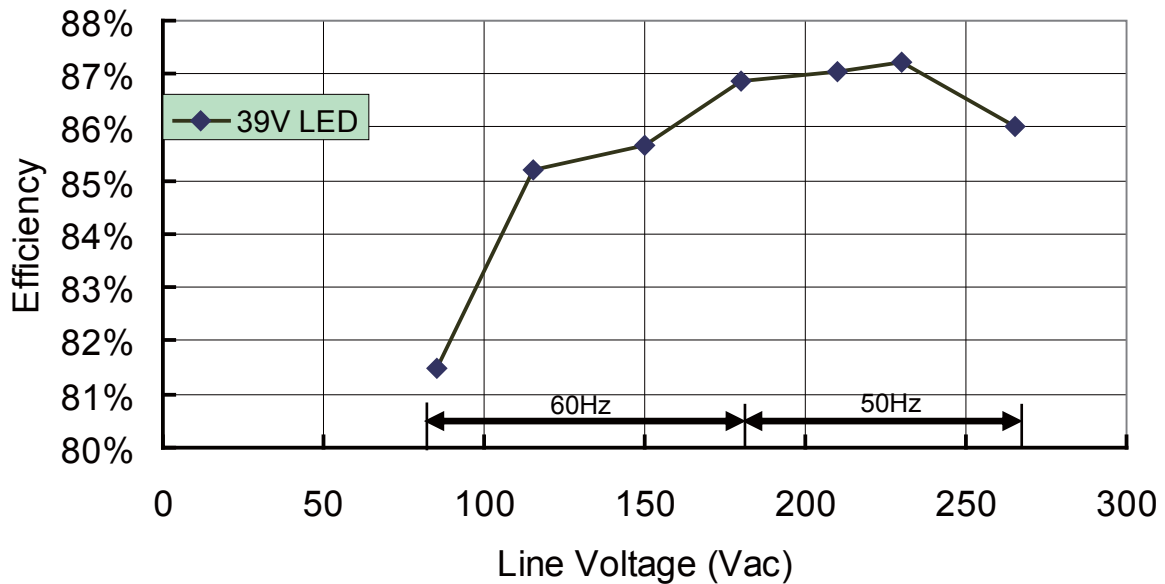

Line Regulation

Line Regulation

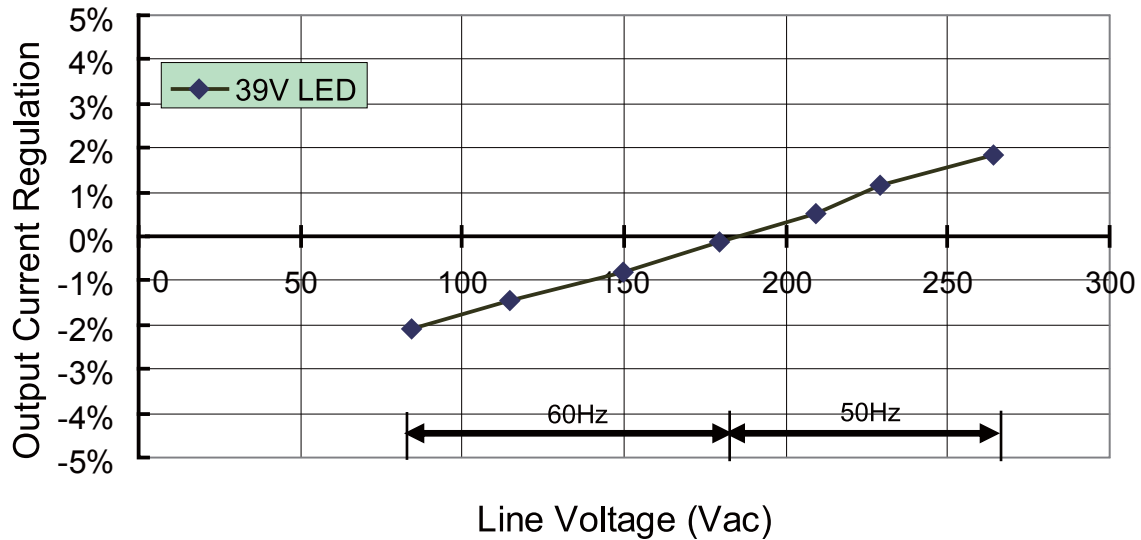

Surge Test

Line-to-Line 500V surge testing was completed according to IEC61547.

Input voltage was set at 230VAC/50Hz. Output was loaded at full load and operation was verified following each surge event.

Surge Level (V)	Input Voltage (VAC)	Injection Location	Injection Phase (°)	Test Result (Pass/Fail)
+/-500	230	L to N	0	Pass
+/-500	230	L to N	90	Pass
+/-500	230	L to N	180	Pass
+/-500	230	L to N	270	Pass

**Conducted EMI Test**

**Conducted EMI Test**

110Vac, 60Hz, Maximum Load,  
L Line, EN55015 Limits

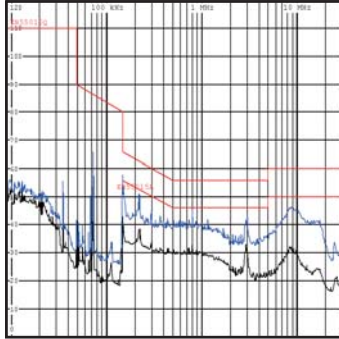

**Conducted EMI Test**

110Vac, 60Hz, Maximum Load,  
N Line, EN55015 Limits

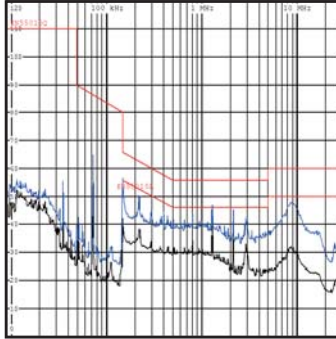

**Conducted EMI Test**

220Vac, 50Hz, Maximum Load,  
L Line, EN55015 Limits

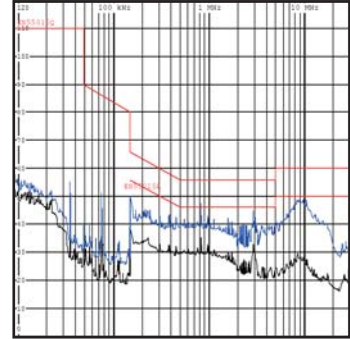

**Conducted EMI Test**

220Vac, 50Hz, Maximum Load,  
N Line, EN55015 Limits

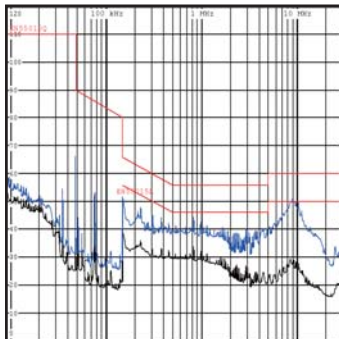

**Thermal Test**

Test with 85Vac input and full load condition ( $T_A=25^\circ\text{C}$ )

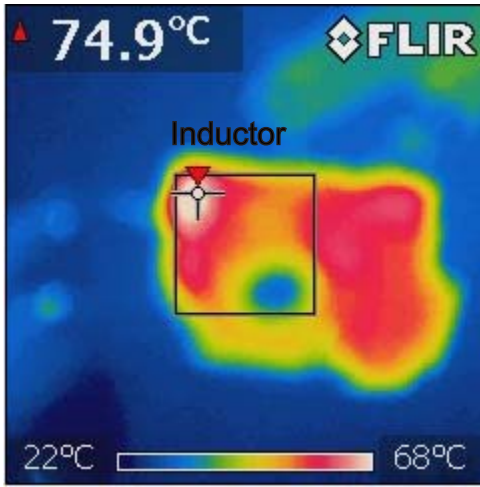

Top Layer

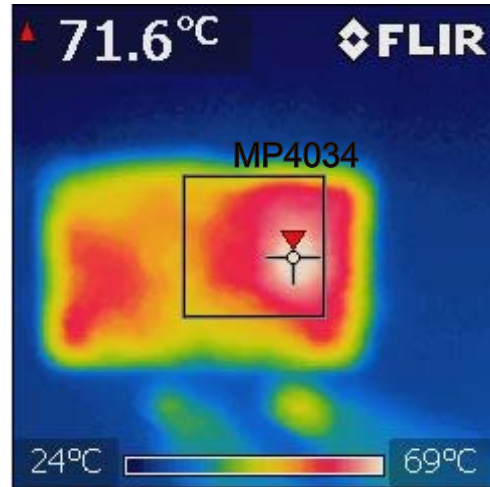

Bottom Layer

## EVB TEST RESULTS

Performance waveforms are tested on the evaluation board.

$V_{IN}=110VAC/60Hz$ , 13 LEDs in series,  $I_{LED}=150mA$ ,  $V_{OUT}=39V$ ,  $L_P=1.18mH$ ,  $N_1:N_2:N_3 = 58:48:14$

Steady State

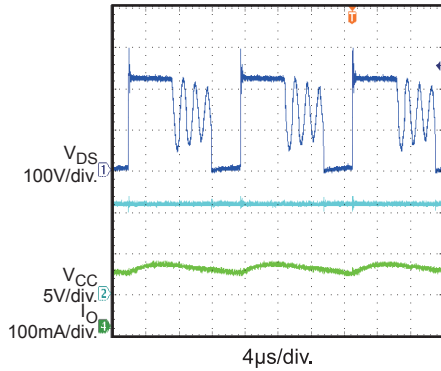

Turn On Delay

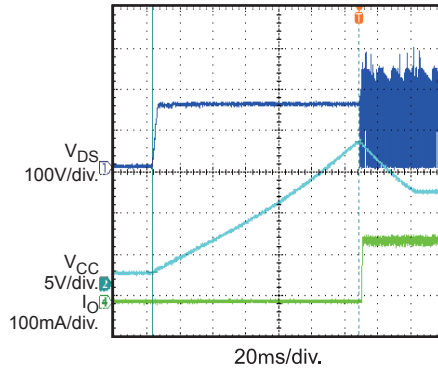

Output Rise Time

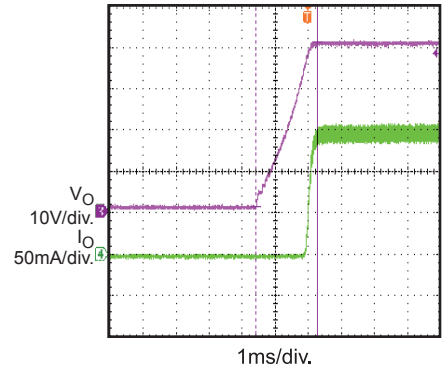

Output Ripple

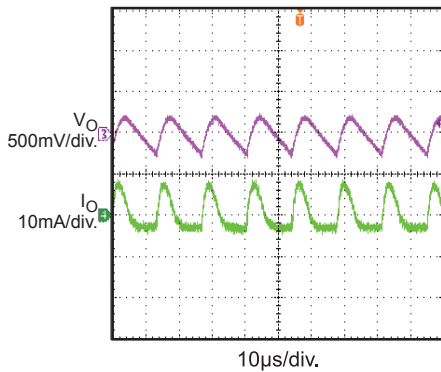

SCP Enter

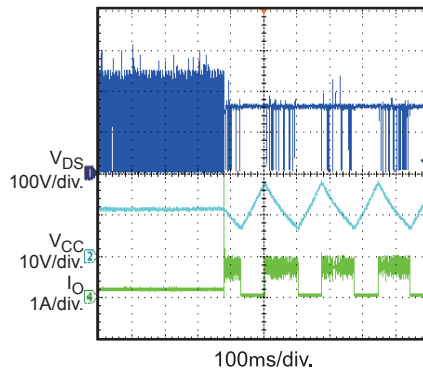

SCP Recovery

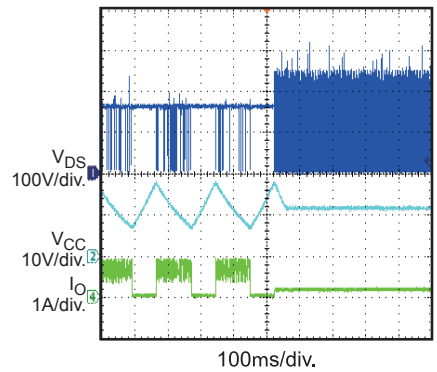

SCP Steady State

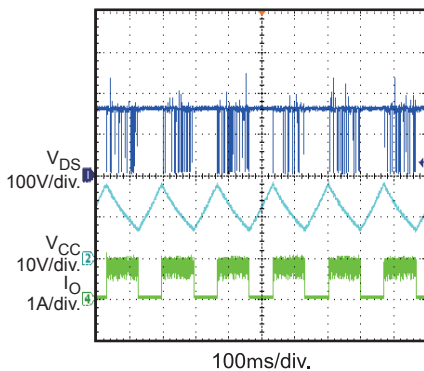

SCP Start Up

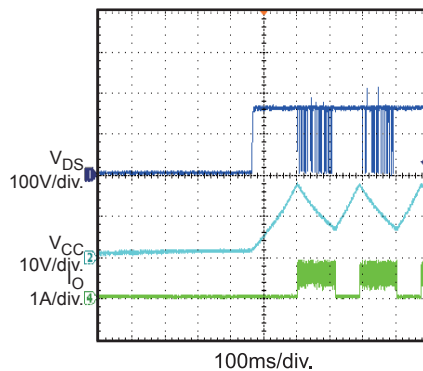

Lamp Open Protection

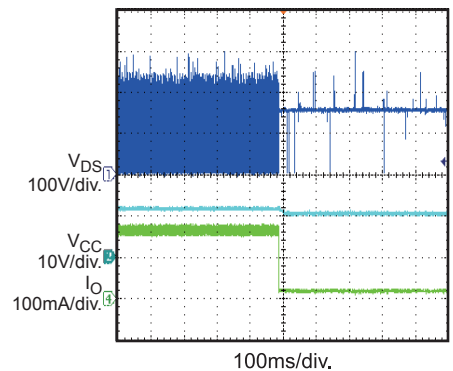

**EVB TEST RESULTS** *(continued)*

Performance waveforms are tested on the evaluation board.

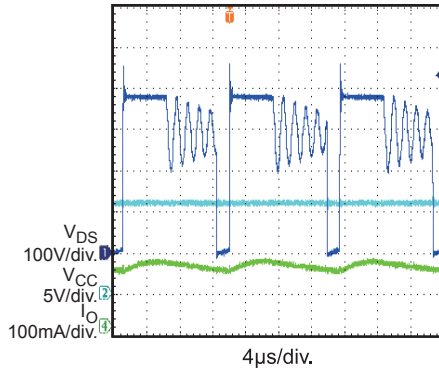
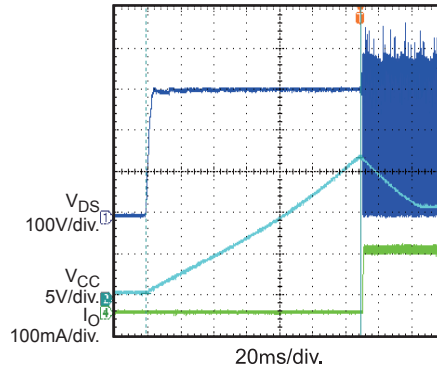
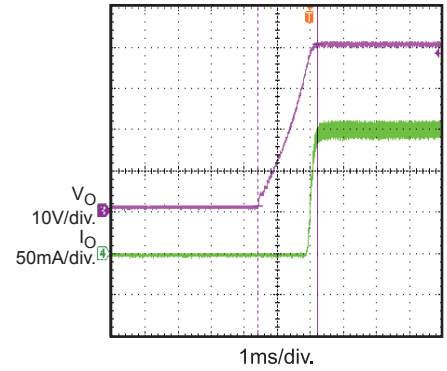
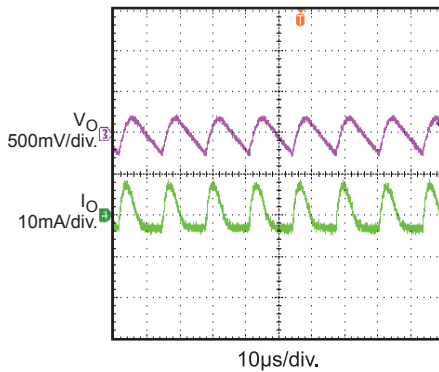
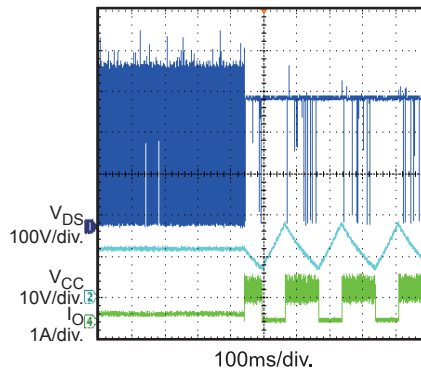
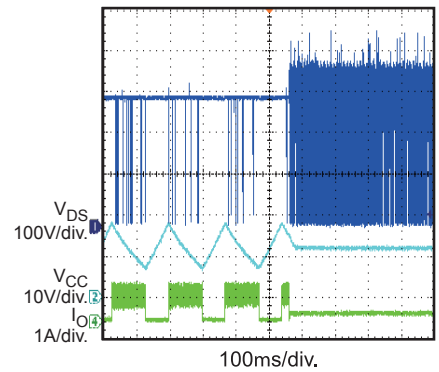
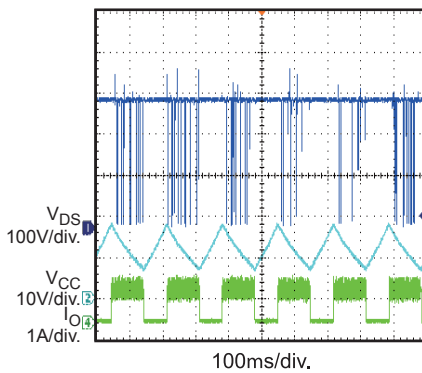
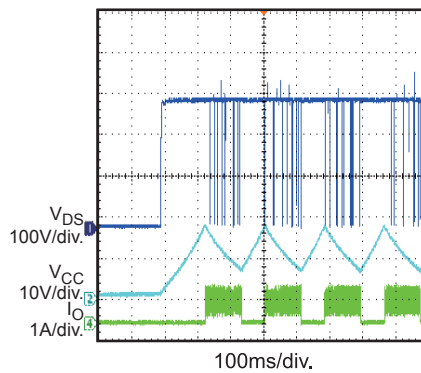
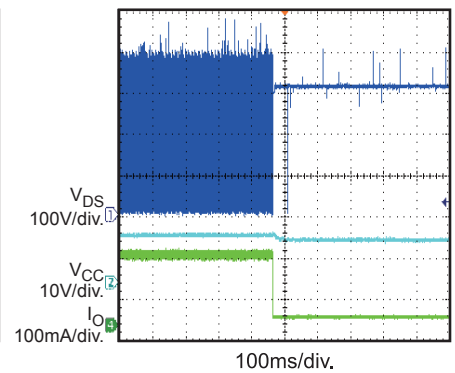
 $V_{IN}=220VAC/50Hz$ , 13 LEDs in series,  $I_{LED}=150mA$ ,  $V_{OUT}=39V$ ,  $L_P=1.18mH$ ,  $N_1:N_2:N_3 =58:48:14$ 
**Steady State**

**Turn On Delay**

**Output Rise Time**

**Output Ripple**

**SCP Enter**

**SCP Recovery**

**SCP Steady State**

**SCP Start Up**

**Lamp Open Protection**

## QUICK START GUIDE

1. Preset AC Power Supply to  $85\text{VAC} \leq V_{\text{IN}} \leq 265\text{VAC}$ .
2. Turn Power Supply off.
3. Connect the LED string between “LED+” (anode of LED string) and “LED-” (cathode of LED string).
4. Connect Power Supply terminals to AC  $V_{\text{IN}}$  terminals as shown on the board.
5. Turn AC Power Supply on after making connections.

**NOTICE:** The information in this document is subject to change without notice. Please contact MPS for current specifications. Users should warrant and guarantee that third party Intellectual Property rights are not infringed upon when integrating MPS products into any application. MPS will not assume any legal responsibility for any said applications.