

DESCRIPTION

The EV4033-K-00B Evaluation Board is designed to demonstrate the capabilities of MP4033 with ripple suppressor. The MP4033 is a primary-side-control offline LED lighting controller which can achieve high power factor and accurate current for Triac dimmable LED lighting application. Its adaptive dimmer type detection and phase-cut-based dimming control can achieve good dimmer compatibility and deep dimming range.

It works in boundary conduction mode for reducing the MOSFET and Diode switching losses. The new ripple suppressor can obviously reduce the output current ripple and escape the flicker or shimmer happened in deep dimming situation with a little influence in efficiency.

The EV4033-K-00B is typically designed for driving an 8W Triac dimmable LED bulb with 24V_{TYP}, 350mA LED load from 108VAC to 132VAC, 50Hz.

The EV4033-K-00B has an excellent efficiency and meets IEC61547 surge immunity, IEC61000-3-2 Class C harmonics and EN55015 conducted EMI requirements. It has multi-protection function as over-voltage protection; winding short circuit protection; output short-circuit protection, cycle by cycle current limit, etc.

ELECTRICAL SPECIFICATION

| Parameter | Symbol | Value | Units |
|------------------------|------------------|------------|-------|
| Input Voltage | V _{IN} | 108 to 132 | VAC |
| Output Voltage | V _{OUT} | 24 | V |
| LED Current | I _{LED} | 350 | mA |
| Output Power | P _{OUT} | 8.4 | W |
| Efficiency (full load) | η | >81 | % |
| Power Factor | PF | >0.9 | |
| THD | THD | <20 | % |

FEATURES

- Fast Start up
- Adaptive Dimmer Type Detection and Phase-Cut-Based Dimming Control
- Triac Dimmable, with Good Dimmer Compatibility and Deep Dimming Range
- The Dimming Curve Meets Standard SSL6
- Direct PWM Dimming
- Real Current Control without Secondary-feedback Circuit
- Programmable Current Fold-back to Prolong the LED Lifetime (NTC)
- Accurate Line & Load Regulation
- High Power Factor over 198VAC to 265VAC
- Boundary Conduction Mode Improves Efficiency
- Input UVLO
- Cycle-by-cycle Current Limit
- Over-voltage Protection (OVP)
- Output Short-circuit Protection (SCP)
- Winding Short Circuit Protection
- ZCD Pin Short Circuit Protection
- Over-temperature Protection (OTP)
- Fit inside A19 Bulb Enclosure

APPLICATIONS

- Solid State Lighting
- Industrial & Commercial Lighting
- Residential Lighting

All MPS parts are lead-free and adhere to the RoHS directive. For MPS green status, please visit MPS website under Quality Assurance. "MPS" and "The Future of Analog IC Technology", are Registered Trademarks of Monolithic Power Systems, Inc.



Warning: Although this board is designed to satisfy safety requirements, the engineering prototype has not been agency approved. Therefore, all testing should be performed using an isolation transformer to provide the AC input to the prototype board.

EV4033-K-00B EVALUATION BOARD

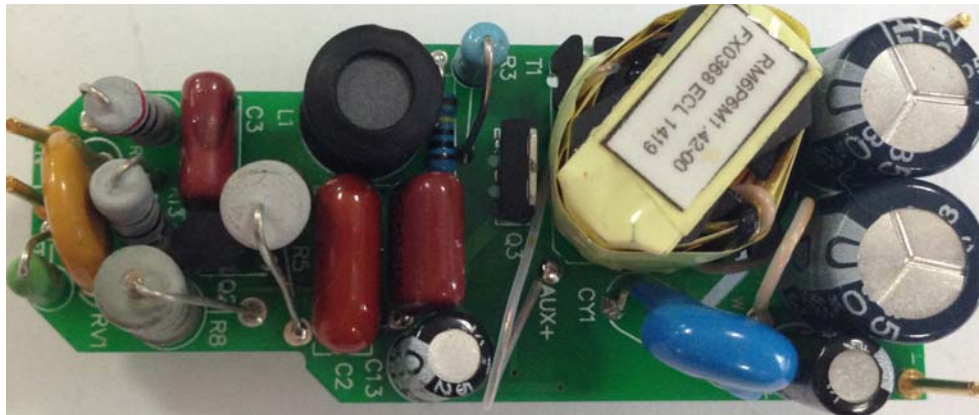
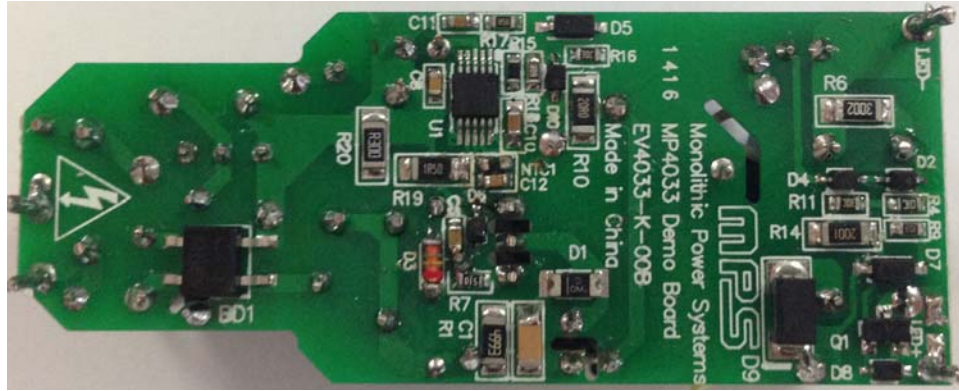

(L x W x H) 62mm x 25mm x 23mm

| Board Number | MPS IC Number |
|--------------|---------------|
| EV4033-K-00B | MP4033GK |

EVALUATION BOARD SCHEMATIC

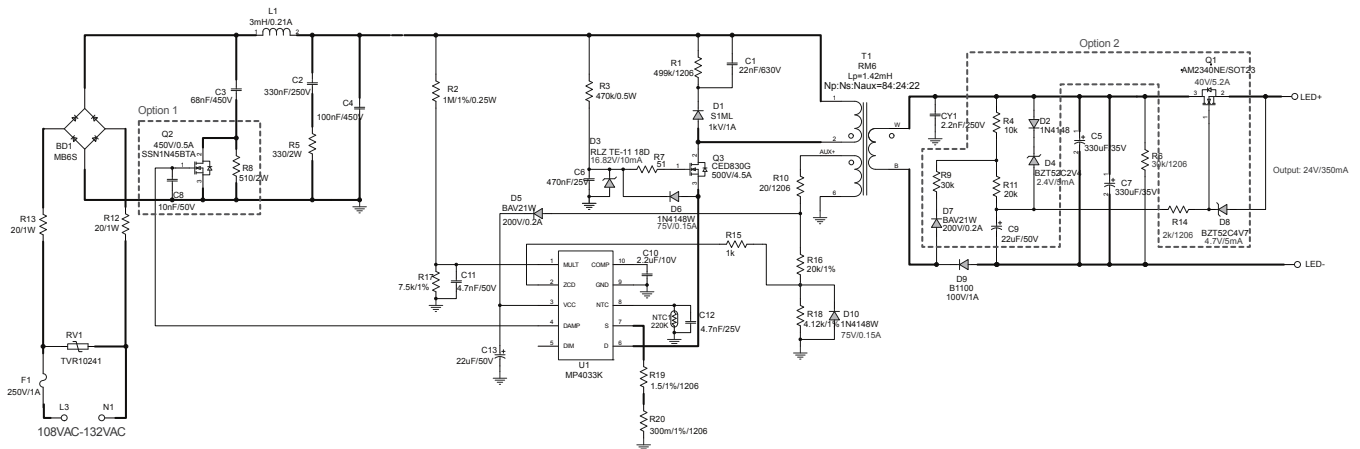

Figure 1—Schematic

PCB LAYOUT (SINGLE-SIDED)

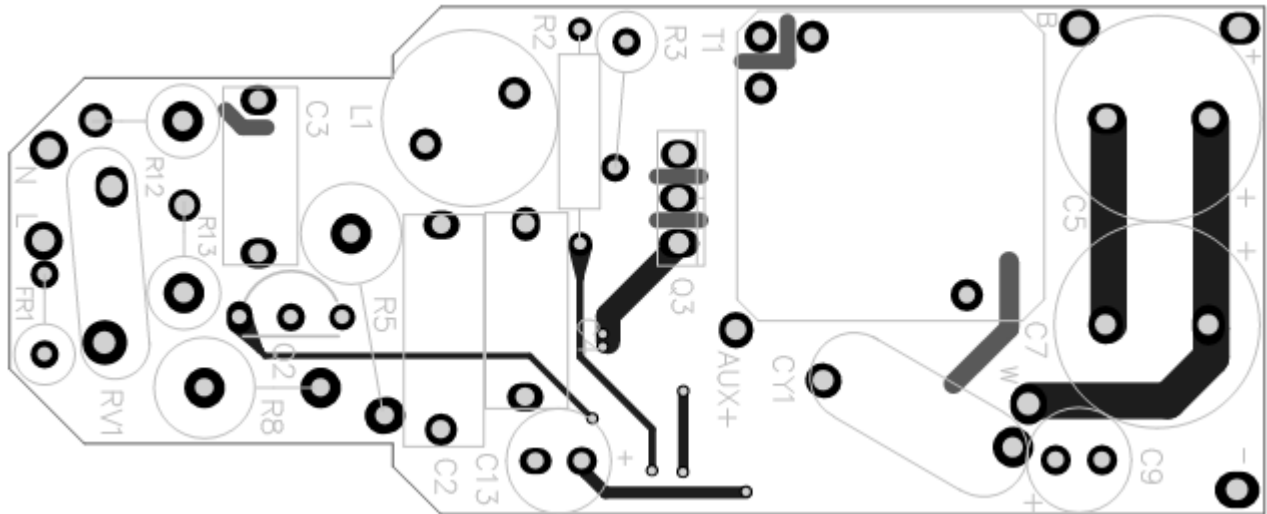

Figure 2—Top Layer

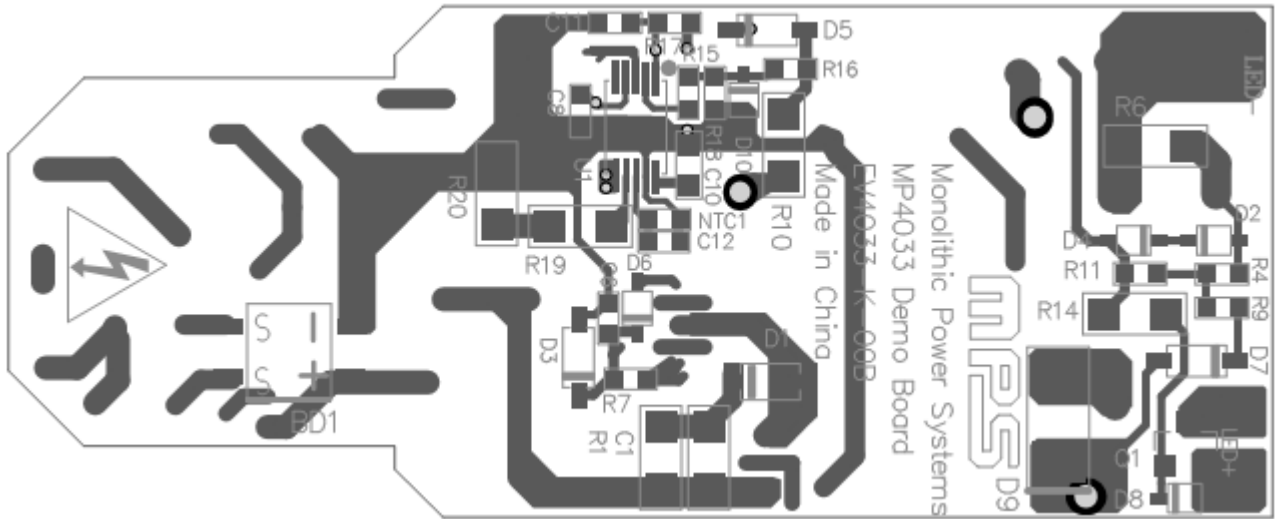

Figure 3—Bottom Layer

CIRCUIT DESCRIPTION

The EV4033-K-00B is configured in a single-stage Flyback topology; it uses primary-side-control which can mostly simplify the schematic and get a cost effective BOM. It can also achieve high power factor and accurate LED current.

F1, RV1, L1, R12, R13, C3, BD1 and C4 compose the input stage. F1 fuses the AC input to protect for the component failure or some excessive short events. RV1 is used for surge test. L1, R12, R13, C3 and C4 associated with CY1 form the EMI filter which can meet the standard EN55015. The diode rectifier BD1 rectifies the input line voltage. Small bulk CBB capacitor C4 is used for a low impedance path for the primary switching current, to maintain high power factor, the capacitance of C4 should be selected with low value.

R8, Q2 with C8 compose the damping circuit.. The dimmer compatibility is well without this circuit. It only helps to reduce the inrush current thro dimmer at the moment dimmer turning on. The circuit let the inrush current flow through R8 at the moment triac dimmer turning on. Then Q2 turns on and shorts R8, this can save power loss from R8.

R5, C2 are used as a bleeder circuit which keeping the triac current above the minimum holding current after triac turns on.

R2, R17, C11 provide sine wave reference for the primary peak current to get an active PFC function. The divided voltage should be lower than the max voltage rating of MULT pin.

R10, D5, and C13 are used to supply the power for MP4033. A 22 μ F bulk capacitor C13 is selected to maintain the supply voltage. At

start-up, C13 is first charged up through the external MOSFET Q3 and internal charging circuit, when the VCC voltage reaches 10V, the internal charging circuit stops charging. Then the power supply is taken over by the auxiliary winding through R10, D5.

R3, C6, R7, D3 and D6 are used for the gate drive of the external MOSFET Q3.

R16, R18 and D10 are used to detect the auxiliary winding to get the transformer magnetizing current zero crossing signal for realizing the boundary conduction operation, and also monitor the output OVP condition. The OVP voltage is set by the divider ratio of R16 and R18.

R19, R20 are primary sensing resistors for primary side current control. The value of R19, R20 set the output LED current. C1, R1, D1 are used to damp the leakage inductance energy so the drain voltage can be suppressed at a safe level.

Diode D9 rectifies the secondary winding voltage and the capacitor C5, C7 are the output filter. The resistor R6 is placed as pre-load to limit the output voltage rise too high in open load condition.

R4, R11, R9, R14, C9, D7, D2, D4, D8, and Q1 compose the ripple suppressor. R4, R11 and C9 offer a stable drive voltage to Q1. D2 and D4 compose the fast start up circuit, which help charge C9 quickly at the moment power on. D7, R9 and R4 add a bias voltage to the gate of Q1, which will help save the power loss of the ripple suppressor obviously.

EV4033-K-00B BILL OF MATERIALS

| Qty | Ref | Value | Description | Package | Manufacturer | Manufacturer_P/N |
|-----|----------|---------------|---|---------|----------------------|--------------------|
| 1 | BD1 | MB6S | BRIDGE, 600V, 0.5A | SOIC-4 | Taiwan Semiconductor | MB6S |
| 1 | C1 | 22nF/630V | Ceramic Cap, 630V, X7R | 1206 | TDK | C3216X7R2J223K |
| 1 | C2 | 330nF/250V | CBB,250V | DIP | | CL21XX-250V-330N |
| 1 | C3 | 68nF/450V | 683/450V | DIP | Fala | C222S683J30C000 |
| 1 | C4 | 100nF/450V | 104/450V | DIP | Fala | C222S104K30C000 |
| 2 | C5, C7 | 330µF/35V | Electrolytic Capacitor, 35V, Electrolytic | DIP | JiangHai | CD263-35V330 |
| 1 | C6 | 470nF/50V | Ceramic Cap,X7R,50V | 0603 | muRata | GRM188R71E474KA12D |
| 1 | C13 | 22µF/50V | Electrolytic Capacitor; 50V;Electrolytic | DIP | Jianghai | CD281L-50V22 |
| 1 | C10 | 2.2µF/10V | Ceramic Cap,10V,X7R | 0603 | muRata | GRM188R71A225KE15D |
| 2 | C11, C12 | 4.7nF/50V | Ceramic Cap,X7R,50V | 0603 | muRata | GRM188R71H472KA01D |
| 1 | CY1 | 2.2nF/4000V | Y Capacitor,4000V | DIP | Hongke | JNK12E222MY02N |
| 1 | D1 | WSGC10MH | Diodes,1000V,1A | SOD-123 | ZOWIE | WSGC10MH |
| 1 | D3 | RLZ TE-11 18D | Zener DIODES/16.82V, 10mA | SOD-123 | ROHM | RLZ TE-11 18D |
| 1 | D5 | BAV21W | Diode;200V;0.2A; | SOD-123 | Diodes | BAV21W-7-F |
| 2 | D6, D10 | 1N4148WS | Diode;75V;0.15A; | SOD-323 | Diodes | 1N4148WS-7-F |
| 1 | D9 | B1100 | Diode;100V;1A | SMA | Diodes | B1100-13-F |
| 1 | F1 | 250V/1A | Fuse | DIP | any | |
| 1 | L1 | Inductor,3mH | Inductor,3mH/DR8*10 | DIP | Hulsin | HDR0810-302M |
| 1 | NTC | 220kΩ | Thermistor | 0603 | muRata | MCP13WM224E03R8 |
| 1 | Q3 | CED830G | N-Channel MOSFET, 500V, 4.5A | TO-251 | CET | CED830G |
| 1 | R1 | 499kΩ | Film RES, 1% | 1206 | Yageo | RC1206FR-07499KL |
| 1 | R2 | 1MΩ | DIP,0.25W RESISTOR | DIP | any | 1MΩ/0.25W |
| 1 | R3 | 470kΩ/0.5W | Resistor;5%;0.5W | DIP | any | 470kΩ/0.5W |
| 1 | R5 | 330Ω | DIP,2W RESISTOR | DIP | any | 330Ω/2W |
| 1 | R6 | 30kΩ | Resistor;1% | 1206 | Yageo | RC1206FR-0730kL |
| 1 | R7 | 51Ω | Film RES,1% | 0603 | Yageo | RC0603FR-0751RL |
| 1 | R10 | 20Ω | Film RES;1% | 1206 | Yageo | RC1206FR-0720RL |
| 2 | R12, R13 | 20Ω | DIP,1W RESISTOR | DIP | any | 20Ω/1W |
| 1 | R15 | 1kΩ | Film RES, 1% | 0603 | Yageo | RC0603FR-071KL |
| 1 | R16 | 20kΩ | Film RES, 1% | 0603 | Yageo | RC0603FR-0720kL |
| 1 | R17 | 7.5kΩ | Film RES, 1% | 0603 | Yageo | RC0603FR-077K5L |
| 1 | R18 | 4.12kΩ | Film RES, 1% | 0603 | Yageo | RC0603FR-074K12L |

EV4033-K-00B BILL OF MATERIALS (continued)

| Qty | Ref | Value | Description | Package | Manufacturer | Manufacturer_P/N |
|-----|------------|-------------------|---|---------------------|---------------------|---------------------------|
| 1 | R19 | 1.5Ω | Film RES, 1% | 1206 | Royalohm | 1206F150KT5E |
| 1 | R20 | 300mΩ | Film RES, 1% | 1206 | Yageo | RL1206FR-070R3L |
| 1 | RV1 | TVR10241KSY | 240V/2500A | DIP | TKS | TVR10241KSY |
| 1 | T1 | RM6 | RM6, Lp=1.42mH Np:Ns:Naux=84:24:22, | RM6 | Emei | FX0368 |
| 1 | U1 | MP4033GK | MP4033GK | MSOP10 | MPS | MP4033GK R2 |
| 1 | R8 | 510Ω | DIP, 2W RESISTOR | DIP | any | 510Ω/2W |
| 1 | Q2 | SSN1N45BTA | N-Channel Mosfet450V;4250/10V; 8.5 | TO-92 | Fairchild | SSN1N45BTA |
| 1 | C8 | 10nF/50V | Ceramic Cap,X7R,50V | 0603 | muRata | GRM188R71H103KA01D |
| 1 | C9 | 22uF/50V | Electrolytic Capacitor;50V;Electrol ytic | DIP | Jianghai | CD281L-50V22 |
| 1 | D2 | 1N4148WS | Diode;75V;0.15A; | SOD- 323 | Diodes | 1N4148WS-7-F |
| 1 | D7 | BAV21W | Diode;200V;0.2A; | SOD- 123 | Diodes | BAV21W-7-F |
| 1 | D8 | BZT52C4V7S | Zener Diode, 4.7V, 5mA | SOD- 323 | Diodes | BZT52C4V7S |
| 1 | D4 | BZT52C2V4S | Zener Diode, 2.4V, 5mA | SOD- 323 | Diodes | BZT52C2V4S |
| 1 | Q1 | AM2340NE | N-channel MOSFET, 40V,5.2A | SOT23 | Analog Power | AM2340NE |
| 1 | R4 | 10kΩ | Film RES;1% | 0603 | Yageo | RC0603FR-0710KL |
| 1 | R9 | 30kΩ | Film RES;1% | 0603 | Yageo | RC0603FR-0730KL |
| 1 | R11 | 20kΩ | Film RES;1% | 0603 | Yageo | RC0603FR-0720KL |
| 1 | R14 | 2kΩ | Film RES;1% | 1206 | Yageo | RC1206FR-072KL |

Note:

1. The components in **red** compose the damping circuit, which is used to reduce the inrush current with leading edge dimmer. It is optional.
2. The components in **blue** compose the ripple suppressor. It is optional.

TRANSFORMER SPECIFICATION

Electrical Diagram

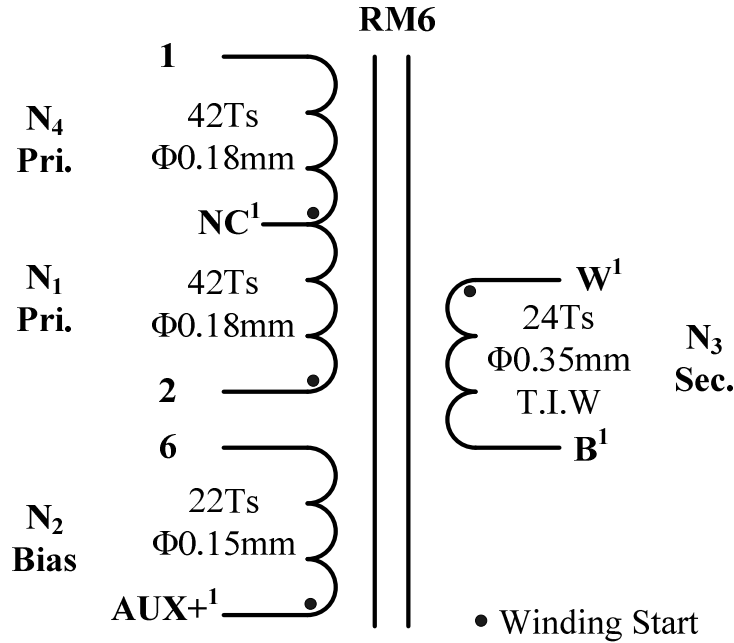

Figure 4—Transformer Electrical Diagram

Notes:

1. Don't connect NC to any pin of Bobbin.
2. W and B are pulled out and marked with different Teflon tube.

Winding Diagram

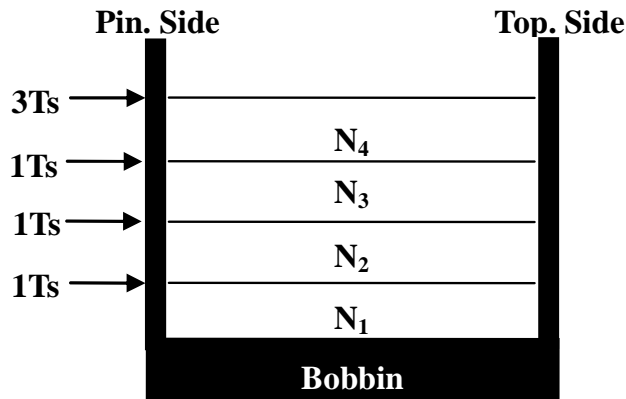

Figure 5—Winding Diagram

Winding Order

| Winding No. | Tape Layer Number | Start & End | Magnet Wire Φ (mm) | Turns |
|----------------|-------------------|-------------|-------------------------|-------|
| N ₁ | 0 | 2→NC | 0.18mm * 1 | 42 |
| N ₂ | 1 | Aux+→6 | 0.15mm * 1 | 22 |
| N ₃ | 1 | W→B | 0.35mm (T.I.W) | 24 |
| N ₄ | 1 | NC→1 | 0.18mm * 1 | 42 |

Electrical Specifications

| | | |
|-----------------------------------|--|-----------|
| Electrical Strength | 60 second, 60Hz, from PRI. to SEC. | 2500VAC |
| | 60 second, 60Hz, from PRI. to CORE. | 1000VAC |
| | 60 second, 60Hz, from SEC. to CORE. | 1000VAC |
| Primary Inductance | Pins 1 - 2, all other windings open, measured at 100kHz, 0.1 VRMS | 1.42mH±8% |
| Primary Leakage Inductance | Pins 1 - 2 with all other pins shorted, measured at 100kHz. 0.1 VRMS | 23μH±10% |

Materials

| Item | Description |
|------|---|
| 1 | Core: RM6, UI=2500±25%, AL=221.5H/N ² ±2% GAP, ACME P4 or equivalent |
| 2 | Bobbin: RM6, 3+3PIN RMMOVE PIN6 1SECT TH, PM9630 UL94V-0 |
| 3 | Wire: Φ 0.16mm, 2UEW, CLASS F or equivalent |
| 4 | Triple Insulation Wire: great Φ 0.35mm, TRW(B) or equivalent |
| 5 | TEFLON TUBE: TFL AWG#30 |
| 6 | TEFLON TUBE: TFL AWG#24 |
| 7 | Tape: 6.5mm(W)×0.06mm(TH) |
| 8 | Tape: 4.0mm(W)×0.06mm(TH) |
| 9 | Varnish: JOHN C. DOLPH CO, BC-346A or equivalent |
| 10 | Solder Bar: CHEN NAN: SN99.5/Cu0.5 or equivalent |

EVB TEST RESULTS

Performance Data

Efficiency, PF and THD

| f (Hz) | Vin(V) | Pin(W) | Vo(V) | Io(mA) | Po(W) | Efficiency(%) | PF | THD(%) |
|--------|--------|--------|-------|--------|-------|---------------|-------|--------|
| 60 | 90 | 10.24 | 23.62 | 353 | 8.34 | 81.42 | 0.985 | 12.10 |
| | 100 | 10.10 | 23.62 | 354 | 8.36 | 82.79 | 0.978 | 13.70 |
| | 110 | 10.00 | 23.62 | 355 | 8.39 | 83.85 | 0.970 | 14.60 |
| | 120 | 9.98 | 23.62 | 356 | 8.41 | 84.26 | 0.960 | 16.00 |
| | 132 | 9.96 | 23.62 | 357 | 8.43 | 84.66 | 0.945 | 17.50 |

Dimming Compatibility (No Flicker with these 32 different Dimmers)

| Manufacturer | Part No. | Power Stage | I _{max} (mA) | I _{min} (mA) | Dimming ratio |
|--------------|----------------|-------------|-----------------------|-----------------------|---------------|
| LUTRON | Q-600P-IV | 600W | 357 | 22 | 6.16% |
| LUTRON | CN-600P | 600W | 357 | 11 | 3.08% |
| LUTRON | AY-600P | 600W | 356 | 17 | 4.78% |
| LUTRON | SLV-600P | 600W | 356 | 13 | 3.65% |
| LUTRON | LG-600P | 600W | 356 | 9 | 2.53% |
| LUTRON | 6B38-Q-600P | 600W | 355 | 19 | 5.35% |
| LUTRON | GL-600H-DK | 600W | 358 | 5 | 1.40% |
| LEVITON | 1G4005 | 600W | 358 | 0 | 0.00% |
| LEVITON | 1I2005 | 600W | 357 | 0 | 0.00% |
| LUTRON | GLV02-F06392 | 600W | 358 | 0 | 0.00% |
| LEVITON | 6633-P | 600W | 357 | 0 | 0.00% |
| LUTRON | 6B38-S-600P | 600W | 358 | 3 | 0.84% |
| LUTRON | CT-600P | 600W | 354 | 4 | 1.13% |
| LUTRON | 6B38-S-603PG | 600W | 297 | 5 | 1.68% |
| LUTRON | 6B38-DV-600P | 600W | 354 | 4 | 1.13% |
| LUTRON | DVCL-153P | 600W | 357 | 42 | 11.76% |
| LUTRON | 6B38-DVLV-600P | 600W | 354 | 13 | 3.67% |
| LEVITON | 1L1005 | 600W | 357 | 0 | 0.00% |
| LUTRON | GLS01-C06570 | 600W | 302 | 0 | 0.00% |
| LUTRON | DV-600P-BR | 600W | 354 | 7 | 1.98% |
| LEVITON | 6613-PL | 600W | 357 | 0 | 0.00% |
| LEVITON | C20-6684-IW | 600W | 356 | 0 | 0.00% |
| LUTRON | AY-600P-LA | 600W | 355 | 27 | 7.61% |
| LUTRON | TG-600PH-WH | 600W | 354 | 21 | 5.93% |
| LUTRON | TG-603GH-WH | 600W | 261 | 18 | 6.90% |
| LUTRON | S-600 | 600W | 357 | 6 | 1.68% |
| LUTRON | DVPDC-203P-WH | 200W | 357 | 63 | 17.65% |
| LUTRON | S-600P | 600W | 357 | 3 | 0.84% |
| LUTRON | 6B38-DV-603PG | 600W | 284 | 12 | 4.23% |
| LUTRON | DNG-603PH-WH | 400W | 357 | 0 | 0.00% |
| COOPER | 6B28 | 600W | 357 | 0 | 0.00% |
| LEVITON | 6633-P-1G1005 | 600W | 357 | 2 | 0.56% |

Electric Strength Test

Primary circuit to secondary circuit electric strength testing was completed according to IEC61347-1 and IEC61347-2-13.

Input and output was shorted respectively. 3750VAC/50Hz sine wave applied between input and output for 1min, and operation was verified.

Surge Test

Line to Line 500V and Line to Power Earth 1kV surge testing was completed according to IEC61547. Input voltage was set at 120VAC/60Hz. Output was loaded at full load and operation was verified following each surge event.

| Surge Level (V) | Input Voltage (VAC) | Injection Location | Injection Phase (°) | Test Result (Pass/Fail) |
|-----------------|---------------------|--------------------|---------------------|-------------------------|
| 500 | 120 | L to N | 90 | Pass |
| -500 | 120 | L to N | 270 | Pass |
| 1000 | 120 | L to PE | 90 | Pass |
| -1000 | 120 | L to PE | 270 | Pass |
| 1000 | 120 | N to PE | 90 | Pass |
| -1000 | 120 | N to PE | 270 | Pass |

Thermal Test

Test without dimmer and with dimmer at 90% dimming on phase.

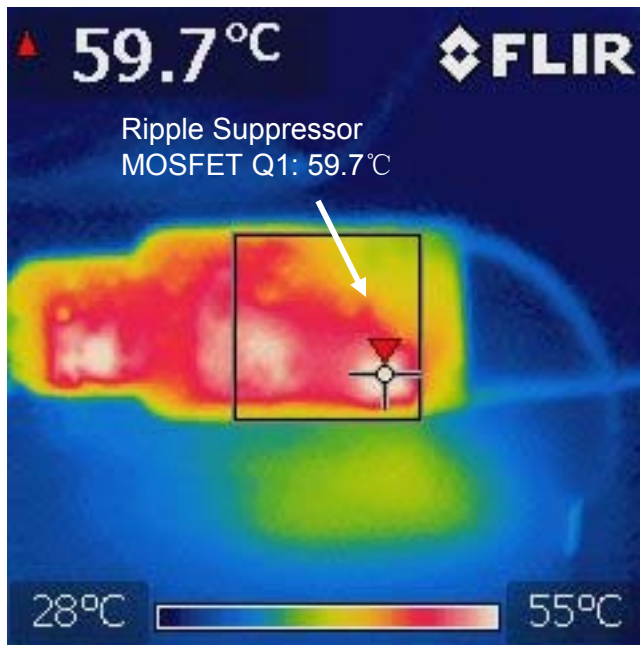

Without dimmer

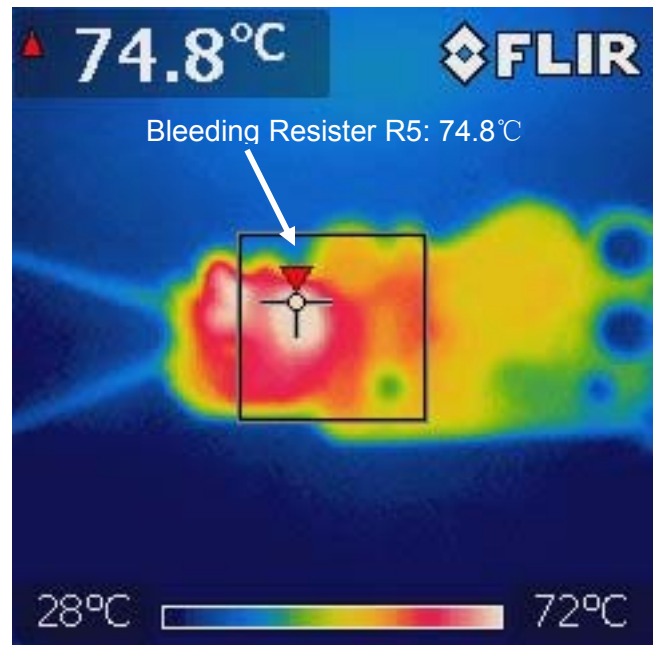

With dimmer at 90% dimming on phase

EVB TEST RESULTS

Performance waveforms are tested on the evaluation board.

$V_{IN}=120V_{AC}/60Hz$, 8 LEDs in series, $I_{LED}=350mA$, $V_{OUT}=24V$, $L_P=1.42mH$, $N_P:N_S:N_{AUX}=84:24:22$

Conducted EMI L-Line

$V_{IN} = 120V_{AC}/60Hz$, Full Load,
RBW = 9kHz, MT = 20ms

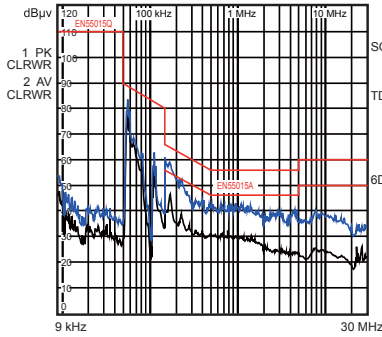

Conducted EMI N-Line

$V_{IN} = 120V_{AC}/60Hz$, Full Load,
RBW = 9kHz, MT = 20ms

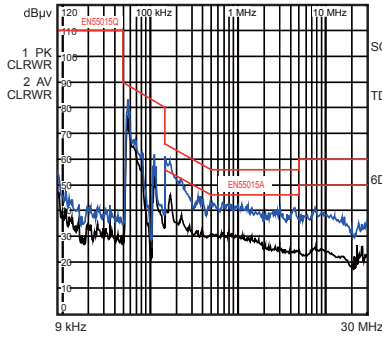

Dimming Curve

$V_{IN}=120V_{AC}/60Hz$, Full Load,
with Different Dimmers

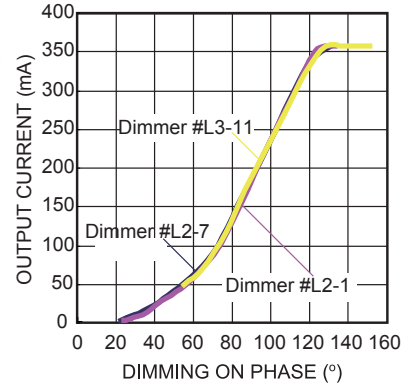

Line Regulation

Full Load

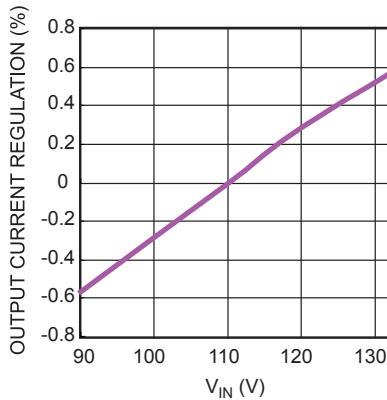

Efficiency vs. V_{IN}

$V_{IN} = (90-132)V_{AC}/60Hz$, Full Load

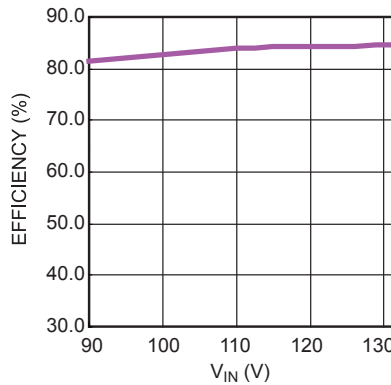

PF vs. V_{IN}

$V_{IN} = (90-132)V_{AC}/60Hz$, Full Load

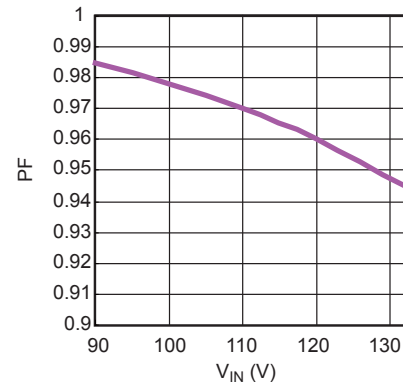

THD vs. V_{IN}

$V_{IN} = (90-132)V_{AC}/60Hz$, Full Load

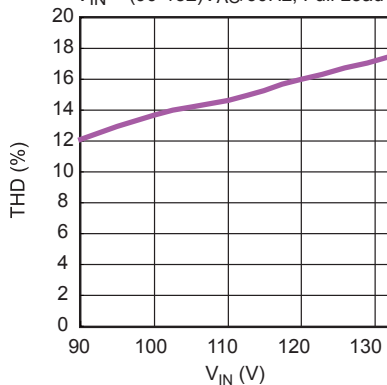

EVB TEST RESULTS (continued)

Performance waveforms are tested on the evaluation board.

 $V_{IN}=120V_{AC}/60Hz$, 8 LEDs in series, $I_{LED}=350mA$, $V_{OUT}=24V$, $L_P=1.42mH$, $N_P:N_S:N_{AUX}=84:24:22$.

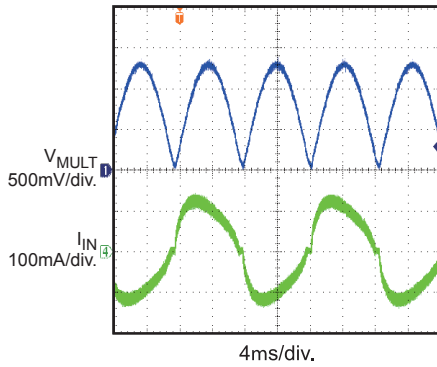
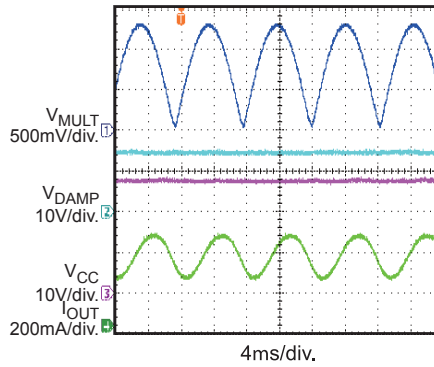
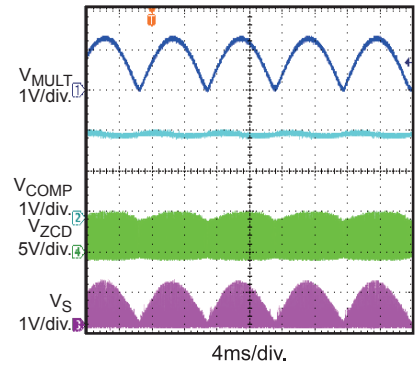
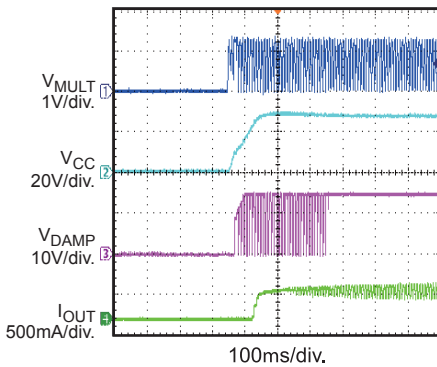
Input Voltage and Current
 $V_{IN}=120V_{AC}/60Hz$, Full Load

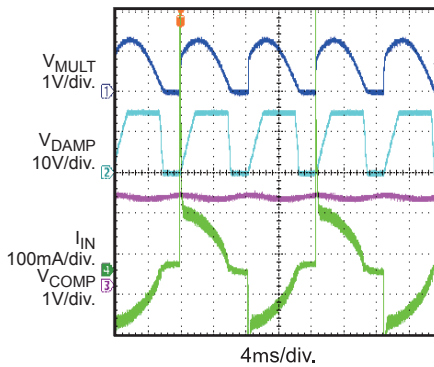
Steady State
 $V_{IN}=120V_{AC}/60Hz$, Full Load

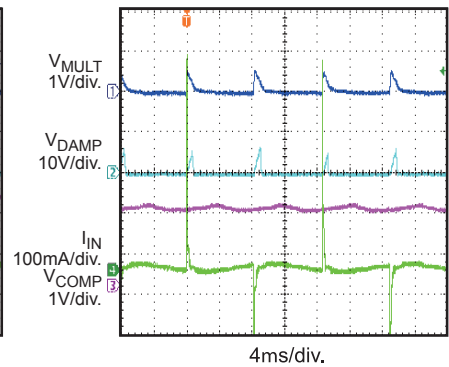
Steady State
 $V_{IN}=120V_{AC}/60Hz$, Full Load

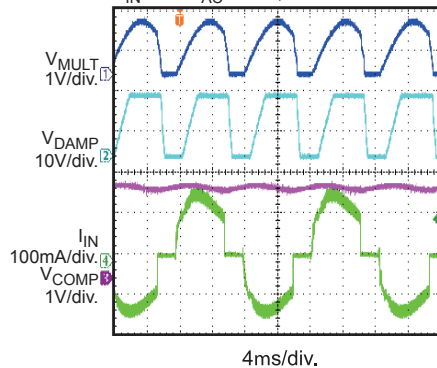
V_{IN} Start Up
 $V_{IN}=120V_{AC}/60Hz$, Full Load

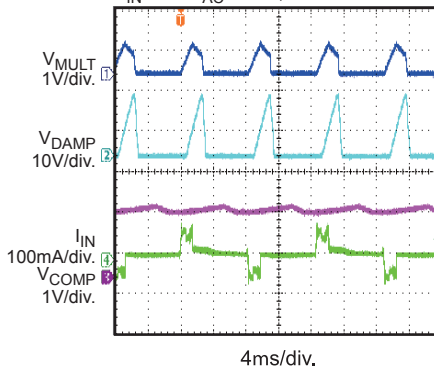
Dimming Performance

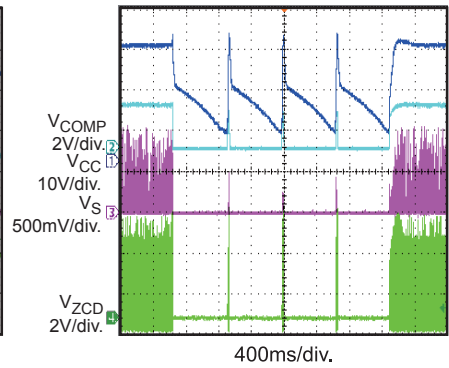
 Max dimming on phase with leading-edge dimmer
 $V_{IN}=120V_{AC}/60Hz$, with dimmer

Dimming Performance

 Min dimming on phase with leading-edge dimmer
 $V_{IN}=120V_{AC}/60Hz$, with dimmer

Dimming Performance

 Max dimming on phase with trailing-edge dimmer
 $V_{IN}=120V_{AC}/60Hz$, with dimmer

Dimming Performance

 Min dimming on phase with trailing-edge dimmer
 $V_{IN}=120V_{AC}/60Hz$, with dimmer

OVP

 LED Load Open then Recovery
 $V_{IN}=120V_{AC}/60Hz$, Full Load

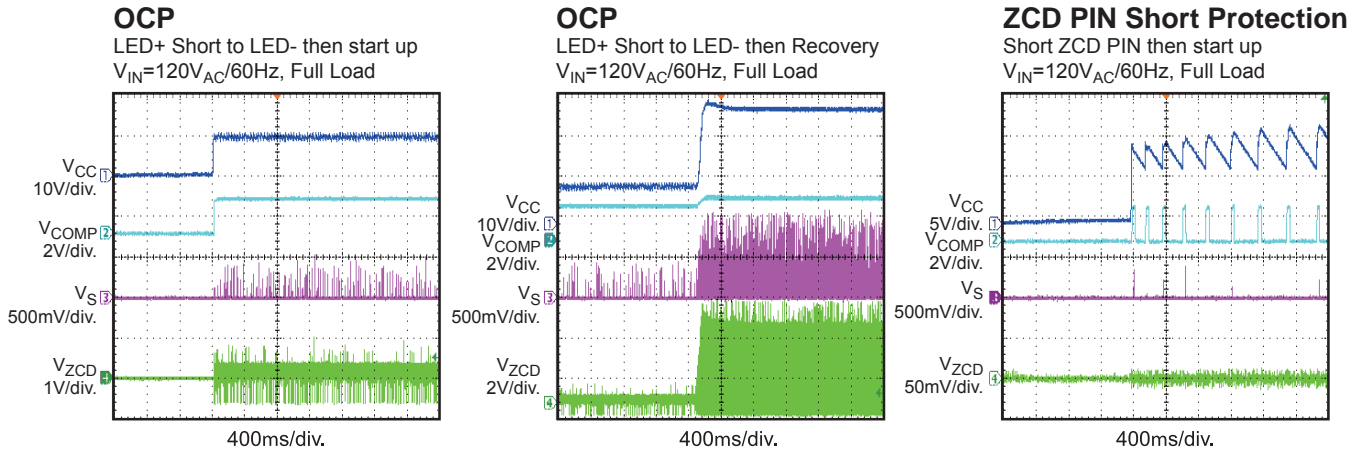
EVB TEST RESULTS (continued)

Performance waveforms are tested on the evaluation board.

 $V_{IN}=120V_{AC}/60Hz$, 8 LEDs in series, $I_{LED}=350mA$, $V_{OUT}=24V$, $L_P=1.42mH$, $N_P:N_S:N_{AUX}=84:24:22$.

QUICK START GUIDE

1. Preset AC Power Supply to $108\text{VAC} \leq V_{\text{IN}} \leq 132\text{VAC}$.
2. Turn Power Supply off.
3. Connect the LED string between “LED+” (anode of LED string) and “LED-” (cathode of LED string).
4. Connect Power Supply terminals to AC V_{IN} terminals as shown on the board.
5. Turn AC Power Supply on after making connections.

NOTICE: The information in this document is subject to change without notice. Users should warrant and guarantee that third party Intellectual Property rights are not infringed upon when integrating MPS products into any application. MPS will not assume any legal responsibility for any said applications.