



The Future of Analog IC Technology®

EV4032-1-S-00A

108V_{AC} to 132V_{AC}/60Hz, 18V_{OUT}/350mA

Primary-Side-Control with Active PFC

Off-Line Dimmable LED Driver Evaluation Board

DESCRIPTION

The EV4032-1-S-00A Evaluation Board is designed to demonstrate the capabilities of MP4032-1. The MP4032-1 is a TRIAC-dimmable, primary-side-controlled, offline, LED lighting driver with an integrated 500V MOSFET. It can achieve a high power factor and accurate LED current control for lighting applications in a single-stage converter. It works in boundary conduction mode for reducing the MOSFET and Diode switching losses.

The EV4032-1-S-00A is typically designed for driving a 6.5W Triac dimmable LED bulb with 18V_{TYP}, 350mA LED load from 108V_{AC} to 132V_{AC}, 60Hz.

The EV4032-1-S-00A has an excellent efficiency and meets IEC61547 surge immunity, IEC61000-3-2 Class C harmonics and EN55015 conducted EMI requirements. It has multi-protection function as over-voltage protection, short-circuit protection, cycle by cycle current limit, etc.

ELECTRICAL SPECIFICATION

Parameter	Symbol	Value	Units
Input Voltage	V _{IN}	108 to 132	V _{AC}
Output Voltage	V _{OUT}	18	V
LED Current	I _{LED}	350	mA
Output Power	P _{OUT}	6.5	W
Efficiency (Full Load)	η	>82	%
Power Factor	PF	>0.95	
THD	THD	<15	%

FEATURES

- Fast Start Up
- Triac Dimmable, with 1% to 100% Dimming Range and the Dimming Curve Meets Standard SSL6
- Real Current Control without Secondary-Feedback Circuit
- Internal MOSFET with 500V High Voltage Rating
- Unique Architecture for Superior Line Regulation
- High Power Factor >0.95 over 108V_{AC} to 132V_{AC}
- Boundary Conduction Mode Improves Efficiency
- Input UVLO
- Cycle-by-Cycle Current Limit
- Over-Voltage Protection (OVP)
- Short-Circuit Protection (SCP)
- Over-Temperature Protection (OTP)

APPLICATIONS

- Solid State Lighting
- Industrial & Commercial Lighting
- Residential Lighting

All MPS parts are lead-free and adhere to the RoHS directive. For MPS green status, please visit MPS website under Quality Assurance. "MPS" and "The Future of Analog IC Technology", are Registered Trademarks of Monolithic Power Systems, Inc.



High Voltage

Warning: Although this board is designed to satisfy safety requirements, the engineering prototype has not been agency approved. Therefore, all testing should be performed using an isolation transformer to provide the AC input to the prototype board.

EV4032-1-S-00A EVALUATION BOARD

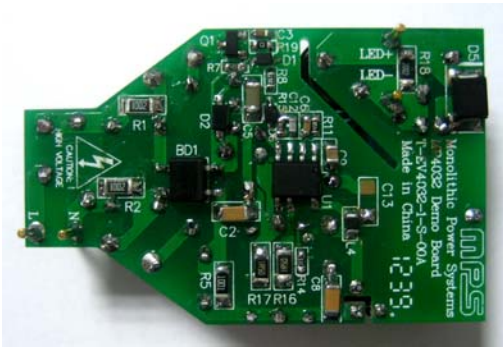

(L x W x H) 50mm x 32mm x 15mm

Board Number	MPS IC Number
EV4032-1-S-00A	MP4032-1

EVALUATION BOARD SCHEMATIC

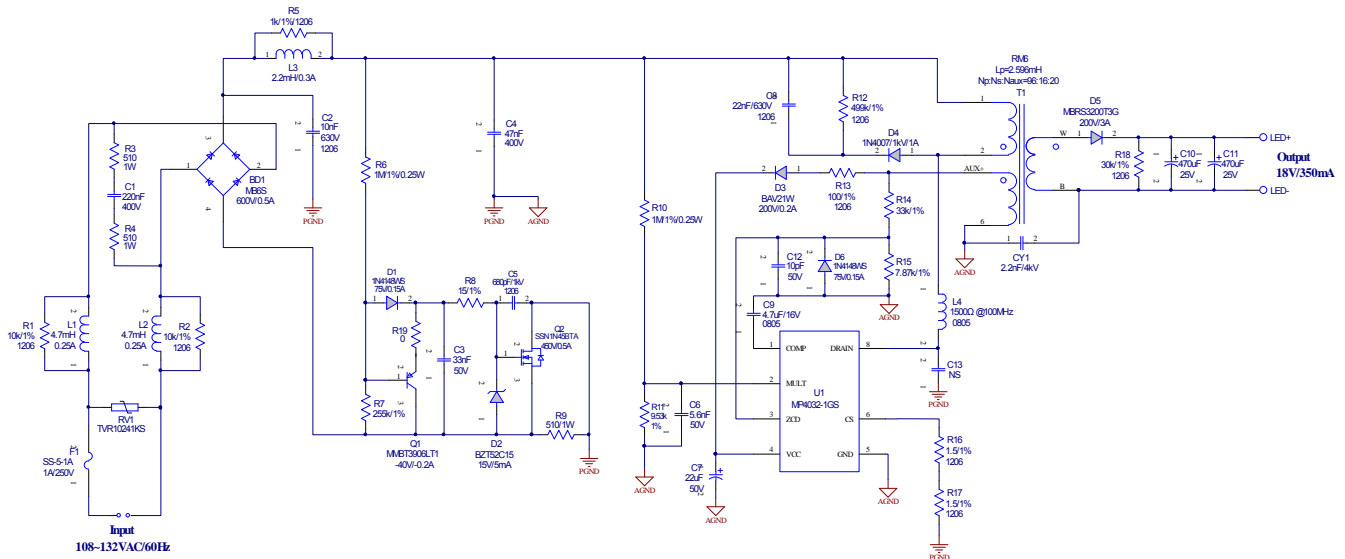

Figure 1—Schematic

PCB LAYOUT (SINGLE-SIDED)

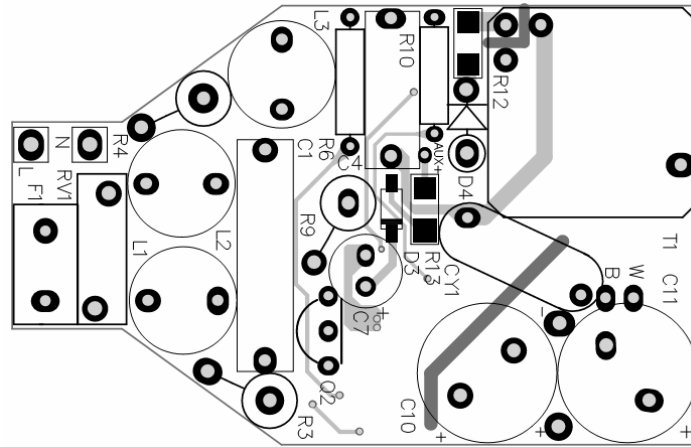

Figure 2—Top Layer

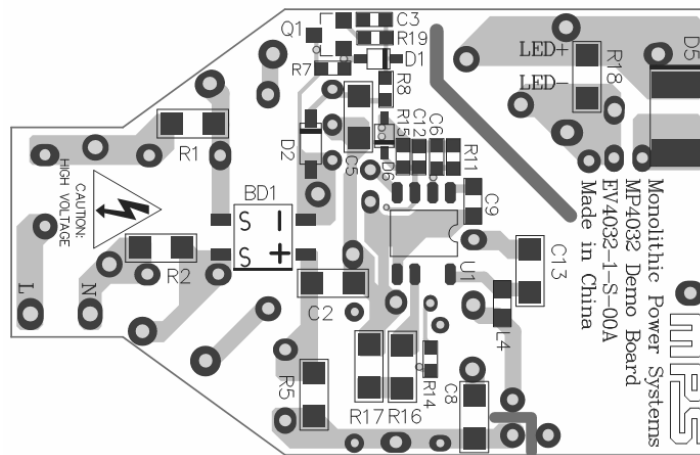

Figure 3—Bottom Layer

CIRCUIT DESCRIPTION

The EV4032-1-S-00A is configured in a single-stage Flyback topology, it uses primary-side-control which can mostly simplify the schematic and get a cost effective BOM. It can also achieve high power factor and accurate LED current.

F1, RV1, L1, L2, R1, R2, BD1, C2, L3, R5 and C4 compose the input stage. F1 fuses the AC input to protect for the component failure or some excessive short events. RV1 is used for surge test. L1, L2, R1, R2, C2, L3, R5 and C4 associated with CY1 form the EMI filter which can meet the standard EN55015. The diode rectifier BD1 rectifies the input line voltage. Small bulk CBB capacitor C4 is used for a low impedance path for the primary switching current, to maintain high power factor, the capacitance of C4 should be selected with low value.

R6, R7, R8, C3, C5, D1, D2, Q1, Q2 with R9 compose the damping circuit for reducing the inrush current at the dimmer turning on time. The circuit let the inrush current flow through R9 at first when triac dimmer turns on. Then Q2 turns on and shorts R9, this can save power from R9. Q1 is used to discharge C3 when the triac is off. D2 is used to clamp the gate voltage of Q2 to 15V.

R3, R4, C1 are used as a bleeder circuit which keeping the triac current above the minimum holding current after triac turns on.

R10, R11, C6 provide sine wave reference for the primary peak current to get an active PFC function. The divided voltage should be lower than the max voltage rating of MULT pin.

R13, D3, C7 are used to supply the power for MP4032-1. A 22 μ F bulk capacitor C7 is selected to maintain the supply voltage. At start-up, C7 is first charged up from the DRAIN pin through an internal high-voltage DRAIN charger. Once the VCC voltage reaches 13.8V, the control logic initiates and the gate drive signal forces the integrated high-voltage power MOSFET to begin switching for normal operation. Meanwhile, the DRAIN charger stops, and the power supply is taken over by the auxiliary winding through R13, D3.

R14, R15 are used to detect the auxiliary winding to get the transformer magnetizing current zero crossing signal for realizing the boundary conduction operation, and also monitor the output OVP condition. The OVP voltage is set by the divider ratio of R14, R15. C12 is used to restrain the oscillation caused by the leakage inductor and the parasitical capacitor to avoid mis-triggering OVP. D6 is used to clamp the negative voltage on ZCD Pin when switch on.

R16, R17 are primary sensing resistors for primary side current control. The value of R16, R17 set the output LED current. C8, R12, D4 are used to damp the leakage inductance energy so the drain voltage can be suppressed at a safe level.

Diode D5 rectifies the secondary winding voltage and the capacitor C10, C11 are the output filter. The resistor R18 is placed as pre-load to limit the output voltage rise too high in open load condition.

EV4032-1-S-00A BILL OF MATERIALS

Qty	Ref	Value	Description	Package	Manufacturer	Manufacturer_P/N
1	BD1	MB6S	Diode;600V;0.5A;	SOIC-4	TaiWan Semiconductor	MB6S
1	C1	220nF	Capacitor;400V;CBB	DIP	Panasonic	ECQE4224KF
1	C2	10nF	Ceramic Capacitor; 630V;X7R;1206;	1206	TDK	C3216X7R2J103K
1	C3	33nF	Ceramic Capacitor; 50V;X7R;0603;	0603	muRata	GRM188R71H333KA61D
1	C4	47nF	Capacitor;400V;CBB	DIP	Panasonic	ECQE4473KF
1	C5	680pF	Ceramic Capacitor; 1000V;U2J;1206;	1206	muRata	GRM31B7U3A681JW31L
1	C6	5.6nF	Ceramic Capacitor; 50V;X7R;0603;	0603	muRata	GRM188R71H562KA01D
1	C7	22uF	Electrolytic Capacitor; 50V;Electrolytic;DIP	DIP	Jianghai	CD281L-50V22
1	C8	22nF	Ceramic Capacitor; 630V;X7R;1206	1206	TDK	C3216X7R2J223K
1	C9	4.7uF	Ceramic Capacitor; 16V;X7R;0805	0805	muRata	GRM21BR71C475KA73L
2	C10, C11	470uF	Electrolytic Capacitor; 25V;Electrolytic	DIP	Rubycon	25ZLF470MEFC10X12.5
1	C12	10pF	Ceramic Capacitor; 50V;C0G;0603;	0603	TDK	C1608COG1H100D
1	C13	NS				
1	CY1	2.2nF	Capacitor;4000V;20%	DIP	Hongke	JNK12E222MY02N
2	D1, D6	1N4148WS	Diode;75V;0.15A;	SOD-323	Diodes	1N4148WS-7-F
1	D2	BZT52C15	Zener Diode; 15V;5mA/500mW;	SOD-123	Diodes	BZT52C15
1	D3	BAV21W	Diode;200V;0.2A;	SOD-123	Diodes	BAV21W-7-F
1	D4	1N4007	Diode;1000V;1A	DO-41	Diodes	1N4007
1	D5	MBRS3200 T3G	Diode;200V;3A;	SMB	ON	MBRS3200T3G
1	F1	SS-5-1A	Fuse;250V;1A	DIP	COOPER BUSSMANN	SS-5-1A
2	L1, L2	4.7mH	Inductor; 4.7mH;9.5;250mA	DIP	Würth	744772472
1	L3	2.2mH	Inductor; 2200uH;4.73 Ohm;0.3A	DIP	Würth	7447720222
1	L4	1500Ω @100MHz	Magnetic Bead; 1500Ω @100MHz; 0.3Ω, 100mA	0805	Würth	742792097

EV4032-1-S-00A BILL OF MATERIALS (continued)

Qty	Ref	Value	Description	Package	Manufacturer	Manufacturer_P/N
1	Q1	MMBT3906L T1	Transistor;-40V;-0.2A;	SOT-23	ON Semiconductor	MMBT3906LT1
1	Q2	SSN1N45BT A	Mosfet;450V;0.5A	TO-92	Fairchild	SSN1N45BTA
2	R1, R2	10kΩ	Film Resistor;1%	1206	Yageo	RC1206FR-0710K
3	R3, R4, R9	510Ω	Resistor;5%;1W	DIP	any	any
1	R5	1kΩ	Resistor;1%	1206	Hottechohm	RI1206L1001FT
2	R6, R10	1MΩ	Resistor;1%;1/4W	DIP	any	any
1	R7	255kΩ	Film Resistor;1%	0603	Yageo	RC0603FR-07255KL
1	R8	15Ω	Film Resistor;1%	0603	Yageo	RC0603FR-0715RL
1	R11	9.53kΩ	Film Resistor;1%	0603	Yageo	RC0603FR-079K53L
1	R12	499kΩ	Film Resistor;1%;	1206	Yageo	RC1206FR-07499KL
1	R13	100Ω	Resistor;1%;1/4W	1206	Yageo	RC1206FR-07100RL
1	R14	33kΩ	Film Resistor;1%;	0603	Yageo	RC0603FR-0733KL
1	R15	7.87kΩ	Film Resistor;1%	0603	Yageo	RC0603FR-077K87L
2	R16, R17	1.5Ω	Resistor;1%	1206	Royalohm	1206F150KT5E
1	R18	30kΩ	Resistor;1%	1206	Yageo	RC1206FR-0730KL
1	R19	0	Film Resistor;5%;	0603	Yageo	RC0603JR-070RL
1	RV1	TVR10241K S	Metal Oxide Varistor; 10mm; 240V; 4000A	DIP	TKS	TVR10241KS
1	T1	FX0281	RM6; Lp=2.596mH; Np:Ns:Naux=96:16:2 0	RM6	Emei	RM6P6M2.6-00
1	U1	MP4032-1	Offline LED Lighting Driver	SOIC8-7A	MPS	MP4032-1GS-Z

TRANSFORMER SPECIFICATION

Electrical Diagram

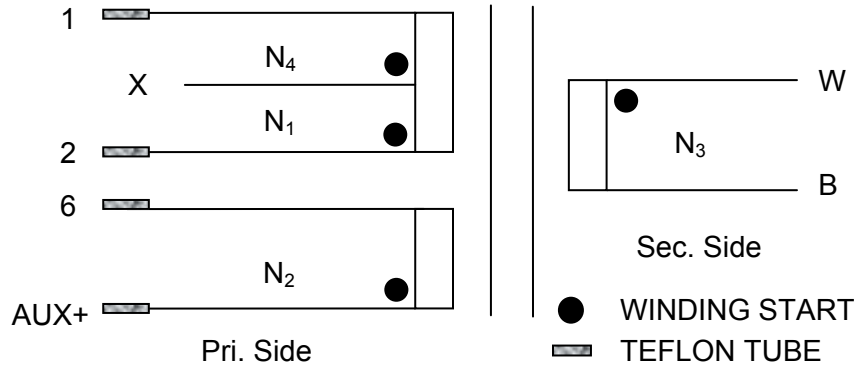

Figure 4—Transformer Electrical Diagram

Notes:

1. Don't connect X to any pin of Bobbin.
2. Don't connect AUX+, W and B to any pin of Bobbin, add black Teflon tube to B, white tube to W.

Winding Diagram

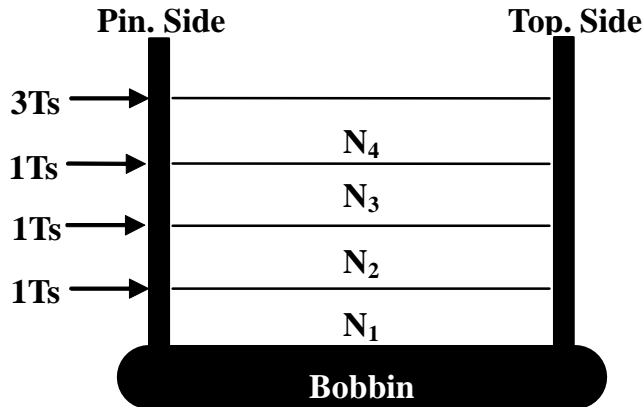

Figure 5—Winding Diagram

Winding Order

Tape Layer Number	Winding No	Start & End	Magnet Wire Φ (mm)	Turns
1	N ₁	2—> X	0.18*1	48
1	N ₂	AUX+—> 6	0.15*1	20
1	N ₃	W—> B	0.35*1(T.I.W)	16
3	N ₄	X—> 1	0.18*1	48

Electrical Specifications

Item	Measurements	Characteristics	Test Conditions T=25±4°C; HR(%)=45±15	REMARK
Primary Inductance (L _p)	PIN(2-1)	2.596mH±8%	f(KHz)=70 U _g (V)=0.25	SERIAL MODE
DCR	PIN(2-1)	3.0Ω MAX.	/	4 WIRES MODE
Turn Ratio	(2-1):(AUX-6):(W-B)	96Ts:20Ts:16Ts±0.5Ts	f(KHz)=20 U _g (V)=1	U _g apply pin(2-1)
Electrical Strength	Pri. Side ~ Sec. Side	NO BREAKDOWN (≤1.0mA)	V _{AC} =3500V	1SEC. F(Hz)=60
	Pri. Side ~ Core	NO BREAKDOWN (≤1.0mA)	V _{AC} =2000V	
	Sec. Side ~ Core	NO BREAKDOWN (≤1.0mA)	V _{AC} =2000V	

Materials

Item	Description
1	Core: RM6, UI=2500±25%, AL=184.5H/N ² ±3% GAP, ACME P4 or equivalent
2	Bobbin: RM6, 3+3PIN RMMOVE PIN6 1SECT TH, PM9630 UL94V-0
3	Wire: Φ 0.15 & 0.18mm, 2UEW, CLASS B or equivalent
4	Triple Insulation Wire: Φ 0.35mm, TRW(B) or equivalent
5	Tape: 6.5mm(W)×0.06mm(TH)
6	Tape: 3.5mm(W)×0.06mm(TH)
7	Varnish: JOHN C. DOLPH CO, BC-346A or equivalent
8	Adhesive: 400-36 or equivalent
9	Solder Bar: CHEN NAN: SN99.5/Cu0.5 or equivalent

EVB TEST RESULTS

Performance Data

Efficiency, PF and THD

f (Hz)	V_{IN} (V _{AC})	I_{IN} (mA)	P_{IN} (W)	V_{OUT} (V)	I_{OUT} (mA)	P_{OUT} (W)	Efficiency (%)	PF	THD (%)
60	108	74	7.97	18.46	354.5	6.544	82.11	0.991	8.9
	110	72	7.92	18.44	353.6	6.520	82.33	0.990	8.9
	115	69	7.86	18.43	353.3	6.511	82.84	0.987	9.0
	120	66	7.81	18.42	353.3	6.508	83.33	0.984	9.1
	125	63	7.79	18.42	353.4	6.510	83.56	0.981	9.2
	130	61	7.76	18.41	353.4	6.506	83.84	0.977	9.2
	132	60	7.75	18.41	353.3	6.504	83.93	0.975	9.2

Dimming Compatibility (No Flicker with these 27 different Dimmers)

Manufacturer	Part No.	Power Stage	I_{MAX} (mA)	I_{MIN} (mA)	Dimming Ratio	Min Start Current (mA)
LUTRON	6B38-DVLV-600P	600W	333	6	1.80%	6
LUTRON	6B38-DV-603PG	600W	241	5	2.07%	5
LUTRON	6B38-S-600P	600W	330	1	0.30%	1
LUTRON	6B38-S-603PG	600W	246	2	0.81%	2
LUTRON	S-600	600W	357	1	0.28%	1
LUTRON	SLV-600P	600W	341	6	1.76%	6
LUTRON	6B38-GL-600-IV	600W	356	8	2.25%	8
LUTRON	NTLV-600-AL	600W	355	6	1.69%	6
LUTRON	AY-600P	600W	342	8	2.34%	8
LUTRON	TG-603GH-WH	600W	221	9	4.07%	9
LUTRON	TG-600PH-WH	600W	341	11	3.23%	11
LUTRON	CN-600P	600W	334	5	1.50%	5
LEVITON	RPI06	600W	357	0	0.00%	11
LEVITON	6633-P-1G1005	600W	357	0	0.00%	1
LUTRON	6B38-Q-600P	600W	341	9	2.64%	9
LUTRON	6B38-DV-600P	600W	329	2	0.61%	2
COOPER	6B28	600W	357	0	0.00%	10
LUTRON	LG-600P	600W	337	3	0.89%	3
LEVITON	1G4005	600W	347	0	0.00%	4
LEVITON	6615-P0W	300W	355	54	15.21%	54
LEVITON	C20-6684-IW	600W	356	0	0.00%	5
LUTRON	DVELV-303P-WH	300W	355	8	2.25%	8
LUTRON	DV-600P-BR	600W	333	3	0.90%	3
LUTRON	DVPDC-203P-WH	200W	355	50	14.08%	50
LUTRON	MAELV-600-WH	600W	344	0	0.00%	13
LUTRON	AY-600P-LA	600W	350	13	3.71%	13
LUTRON	GL-600H-DK	600W	355	2	0.56%	2

Electric Strength Test

Primary circuit to secondary circuit electric strength testing was completed according to IEC61347-1 and IEC61347-2-13.

Input and output was shorted respectively. 3750V_{AC}/50Hz sine wave applied between input and output for 1min, and operation was verified.

Surge Test

Line to Line 1kV surge testing was completed according to IEC61547.

Input voltage was set at 110V_{AC}/60Hz. Output was loaded at full load and operation was verified following each surge event.

Surge Level (V)	Input Voltage (V _{AC})	Injection Location	Injection Phase (°)	Test Result (Pass/Fail)
+1000	110	L to N	0	Pass
-1000	110	L to N	0	Pass
+1000	110	L to N	90	Pass
-1000	110	L to N	270	Pass

Thermal Test

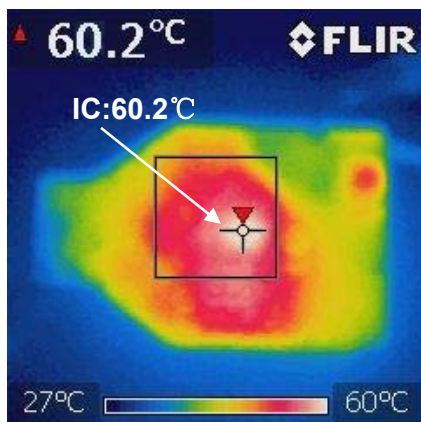

Without dimmer @ V_{IN}=108V_{AC}

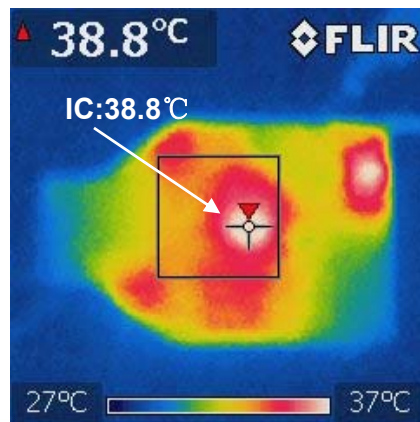

Output short without dimmer @ V_{IN} =132V_{AC}

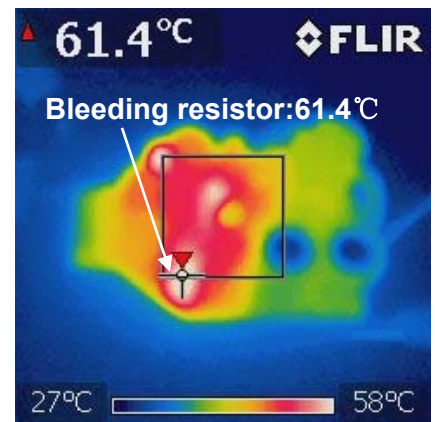

50% dimming @ Vin=120V_{AC}

EVB TEST RESULTS

Performance waveforms are tested on the evaluation board.

$V_{IN}=120V_{AC}/60Hz$, 6 LEDs in series, $I_{LED}=350mA$, $V_{OUT}=18V$, $L_P=2.6mH$, $N_P:N_S:N_{AUX}=96:16:20$

Conducted EMI

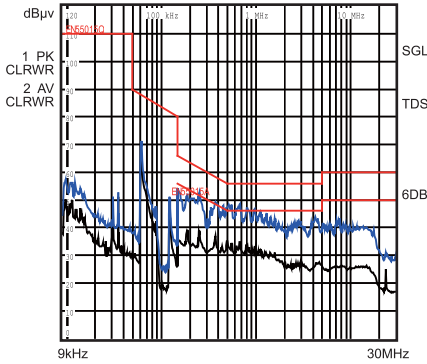

CDN

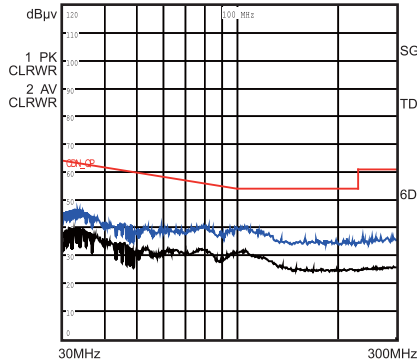

Dimming Curve

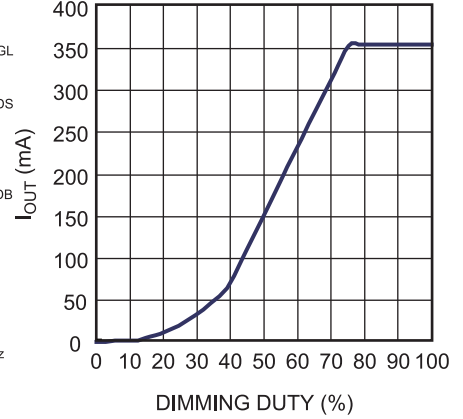

Efficiency vs. V_{IN}

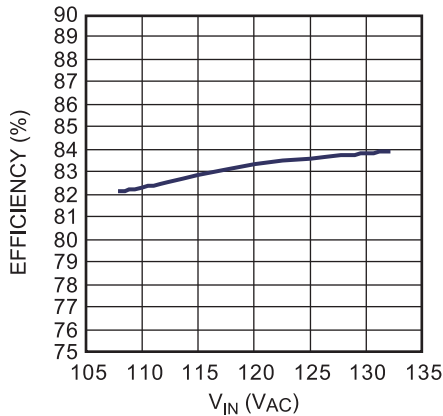

PF vs. V_{IN}

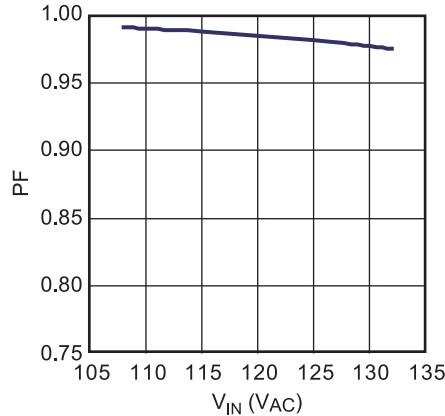

THD vs. V_{IN}

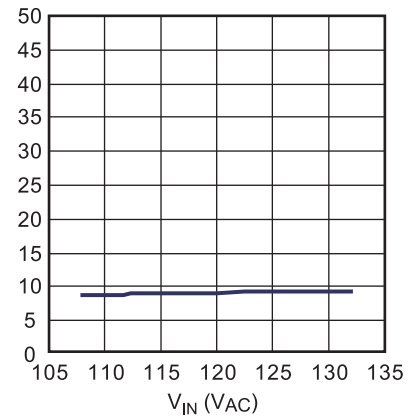

EVB TEST RESULTS *(continued)*

Performance waveforms are tested on the evaluation board.

$V_{IN}=120V_{AC}/60Hz$, 6 LEDs in series, $I_{LED}=350mA$, $V_{OUT}=18V$, $L_P=2.6mH$, $N_P:N_S:N_{AUX}=96:16:20$

Steady State

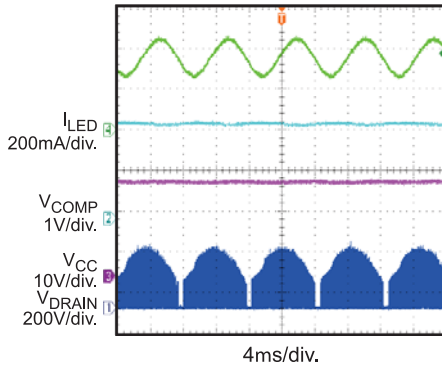

Steady State

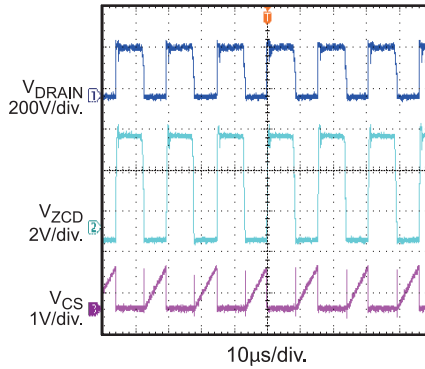

Steady State

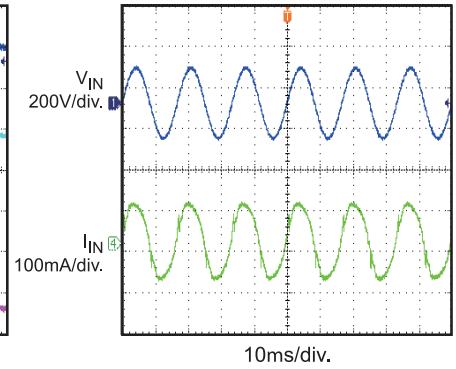

V_{IN} Start-Up

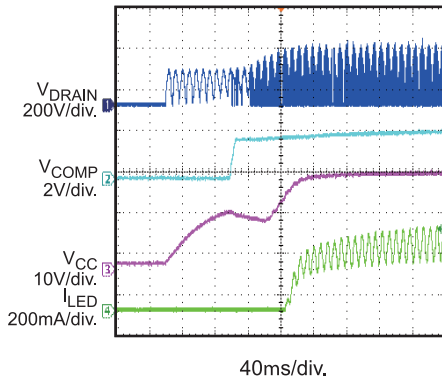

Short Circuit Protection
LED+ Short to LED- When Working

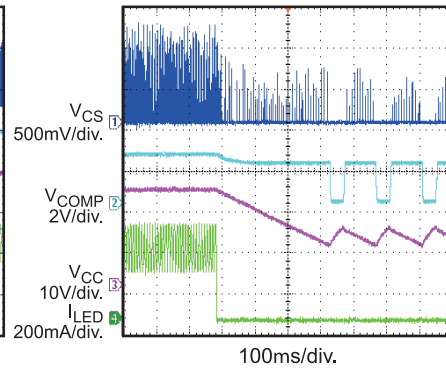

Over Voltage Protection
LED Load Open When Working

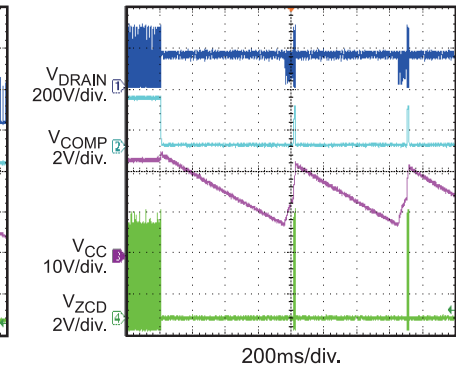

Triac Dimming
Duty=60%

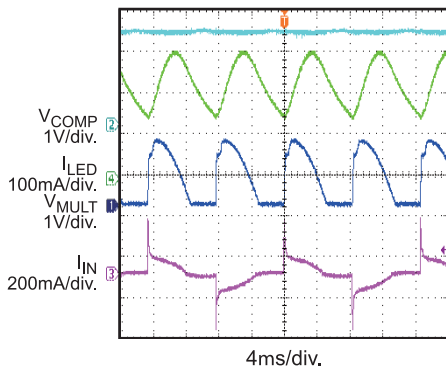

Triac Dimming
Duty=40%

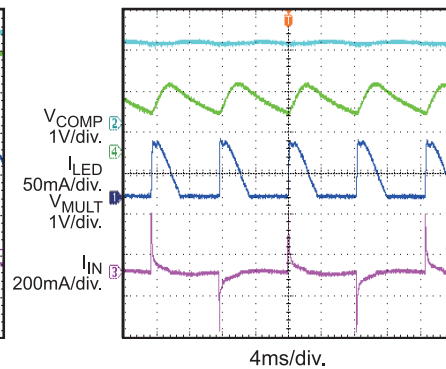

Triac Dimming
Duty=20%

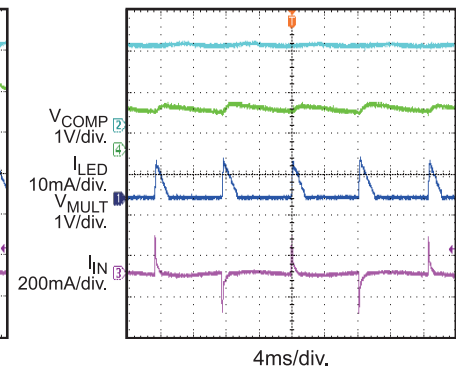

QUICK START GUIDE

1. Preset AC Power Supply to $108V_{AC} \leq V_{IN} \leq 132V_{AC}$.
2. Turn Power Supply off.
3. Connect the LED string between “LED+” (anode of LED string) and “LED-” (cathode of LED string).
4. Connect Power Supply terminals to AC V_{IN} terminals as shown on the board.
5. Turn AC Power Supply on after making connections.
6. For Triac dimming LED lighting application, especially in deep dimming situation, the LED would shimmer caused by the dimming on duty which is not all the same in every line cycle. What's more, the Grid has noise or inrush which would bring out shimmer even flicker. The suppressor circuit would help to improve this. For detailed information please refer to appendix.

**APPENDIX
RIPPLE SUPPRESSOR**

(Innovative Proprietary)

For dimming LED lighting application, a single stage PFC converter needs large output capacitor to reduce the ripple whose frequency is double of the Grid. And in deep dimming situation, the LED would have shimmer caused by the dimming on duty which is not all the same in every line cycle. What's more, the Grid has noise or inrush which would bring out shimmer even flicker. Figure 9 shows a ripple suppressor, which can shrink the LED current ripple obviously.

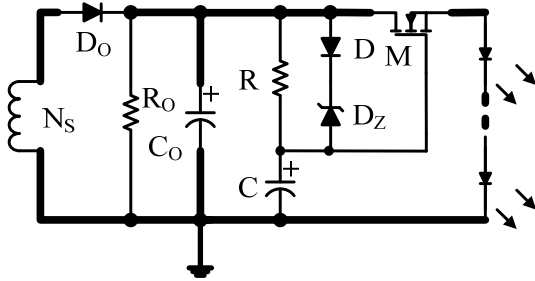

Figure6—Ripple Suppressor

Principle

Shown in Figure 6, Resistor R, capacitor C, and MOSFET M compose the ripple suppressor. Through the RC filter, C gets the mean value of the output voltage V_{Co} to drive the MOSFET M. M works in variable resistance area. C's voltage V_C is steady makes the LEDs voltage is steady, so the LEDs current will be smooth. MOSFET M holds the ripple voltage v_{Co} of the output.

Diode D and Zener diode D_Z are used to restrain the overshoot at start-up. In the start-up process, through D and D_Z , C is charged up quickly to turn on M, so the LED current can be built quickly. When V_C rising up to about the steady value, D and D_Z turn off, and C combines R as the filter to get the mean voltage drop of V_{Co} .

The most important parameter of MOSFET M is the threshold voltage V_{th} which decides the power loss of the ripple suppressor. Lower V_{th} is better if the MOSFET can work in variable resistance area. The BV of the MOSFET can be selected as double as V_{Co} and the Continuous Drain current level can be selected as decuple as the LEDs' current at least.

About the RC filter, it can be selected by $\tau_{RC} \geq 50/f_{LineCycle}$. Diode D can select 1N4148, and the Zener voltage of D_Z is as small as possible when guarantee $V_D + V_{DZ} > 0.5 \cdot V_{Co_PP}$.

Optional Protection Circuit

In large output voltage or large LEDs current application, MOSFET M may be destroyed by over-voltage or over-current when LED+ shorted to LED- at working.

Gate-Source(GS) Over-voltage Protection

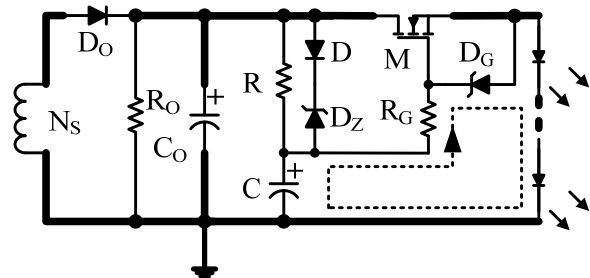

Figure 7—Gate-Source OVP Circuit

Figure 7 shows GS over-voltage protection circuit. Zener diode D_G and resistor R_G are used to protect MOSFET M from GS over-voltage damaged. When LED+ shorted to LED- at normal operation, the voltage drop on capacitor C is high, and the voltage drop on Gate-Source is the same as capacitor C. The Zener diode D_G limits the voltage V_{GS} and R_G limits the charging current to protect D_G . R_G also can limit the current of D_Z at the moment when LED+ shorted to LED-. V_{DG} should bigger than V_{th} .

Drain-Source Over-voltage and Over-current Protection

As Figure 8 shows, NPN transistor T, resistor R_C and R_E are set up to protect MOSFET M from over-current damaged when output short occurs at normal operation. When LED+ shorted to LED-, the voltage v_{DS} of MOSFET is equal to the v_{Co} which has a high surge caused by the parasitic parameter. Zener Diode D_{DS} protects MOSFET

from over-voltage damaged. Transistor T is used to pull down the V_{GS} of M. When M turns off, the load is opened, then the OVP mode is triggered, and the IC functions in quiescent. The pull down point is set by R_C and R_E :

$$R_C/R_E \cdot \frac{V_{CO}}{2} = 0.7V.$$

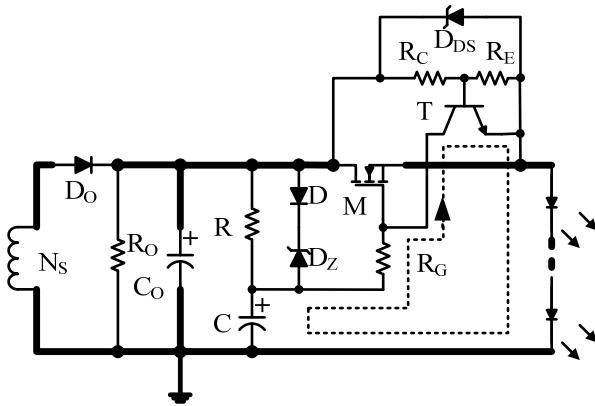

Figure 8—Drain-Source OVP and OCP Circuit

MOSFET LIST

In the Table 1, there are some recommended MOSFET for ripple suppressor.

Table 1: MOSFET LIST

Manufacture P/N	Manufacture	V_{DS}/I_D	$V_{th}(V_{DS}=V_{GS}@T_J=25^\circ C)$	Package	Power Stage
Si4446DY	Vishay	40V/3A	0.6-1.6V@ $I_D=250\mu A$	SO-8	<10W
FTD100N10A	IPS	100V/17A	1.0-2.0V@ $I_D=250\mu A$	TO-252	5-15W
P6015CDG	NIKO-SEM	150V/20A	0.45-1.20V@ $I_D=250\mu A$	TO-252	10-20W

NOTICE: The information in this document is subject to change without notice. Please contact MPS for current specifications. Users should warrant and guarantee that third party Intellectual Property rights are not infringed upon when integrating MPS products into any application. MPS will not assume any legal responsibility for any said applications.