

DESCRIPTION

The EV4027-J-00B Evaluation Board is designed to demonstrate the capabilities of MP4027. The MP4027 is an offline LED lighting controller which can achieve high power factor and accurate LED current for both isolated and non-isolated lighting application in a single stage converter. It works in boundary conduction mode for reducing the MOSFET and Diode switching losses.

The EV4027-J-00B is typically designed for driving a non-isolated 10W Buck PFC LED bulb with 72V_{TYP}, 140mA LED load at low line voltage (90V~132VAC, 60Hz).

The EV4027-J-00B has high performances in efficiency, line/load regulation and meets IEC61547 surges, IEC61000-3-2 Class C harmonics and EN55015 conducted EMI. It has multi-protection function as over-voltage protection, short-circuit protection, inductor OCP, Vin Brown out, NTC, etc.

ELECTRICAL SPECIFICATION

Parameter	Symbol	Value	Units
Input Voltage	V _{IN}	90 ~ 132	VAC
Output Voltage	V _{OUT}	72	V
LED Current	I _{LED}	140	mA
Output Power	P _{OUT}	10	W
Efficiency (full load)	η	90	%
PF		>0.92	

FEATURES

- Small IC package: SOT23-8
- Real current control
- Good line/load regulation
- High power factor>0.92 over input voltage
- Boundary conduction mode improves efficiency
- NTC function
- Input UVLO
- Inductor over current protection
- Over-voltage protection
- Short-circuit protection
- Over-temperature protection
- Fit inside B10 bulb enclosure

APPLICATIONS

- Solid State Lighting
- Industrial & Commercial Lighting
- Residential Lighting

All MPS parts are lead-free and adhere to the RoHS directive. For MPS green status, please visit MPS website under Quality Assurance. "MPS" and "The Future of Analog IC Technology", are Registered Trademarks of Monolithic Power Systems, Inc.



Warning: Although this board is designed to satisfy safety requirements, the engineering prototype has not been agency approved. Therefore, all testing should be performed using an isolation transformer to provide the AC input to the prototype board.

EV4027-J-00B EVALUATION BOARD

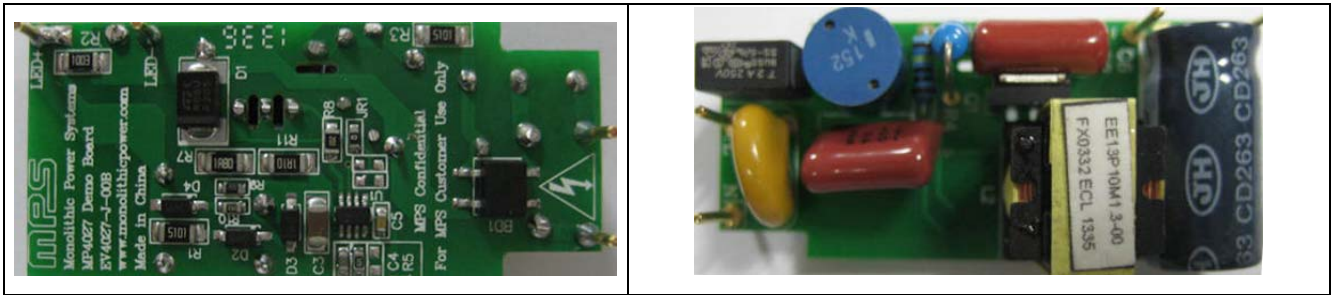

(L x W x H) 50.5mm x 22.4mm x 16mm

Board Number	MPS IC Number
EV4027-J-00B	MP4027GJ

EVALUATION BOARD SCHEMATIC

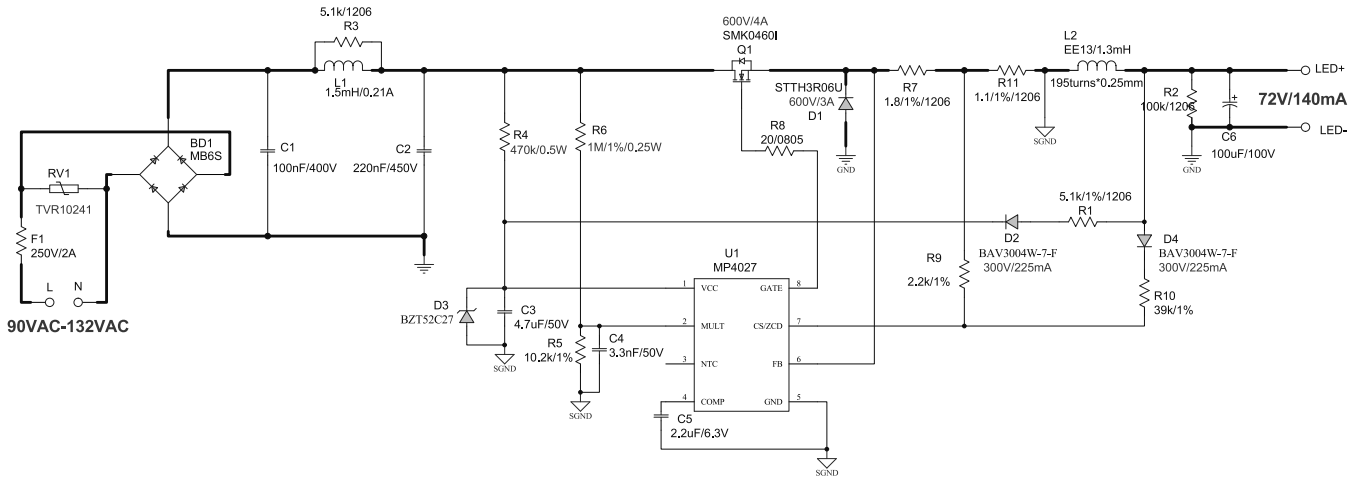

Figure 1 - Schematic

PCB LAYOUT (DOUBLE-SIDED)

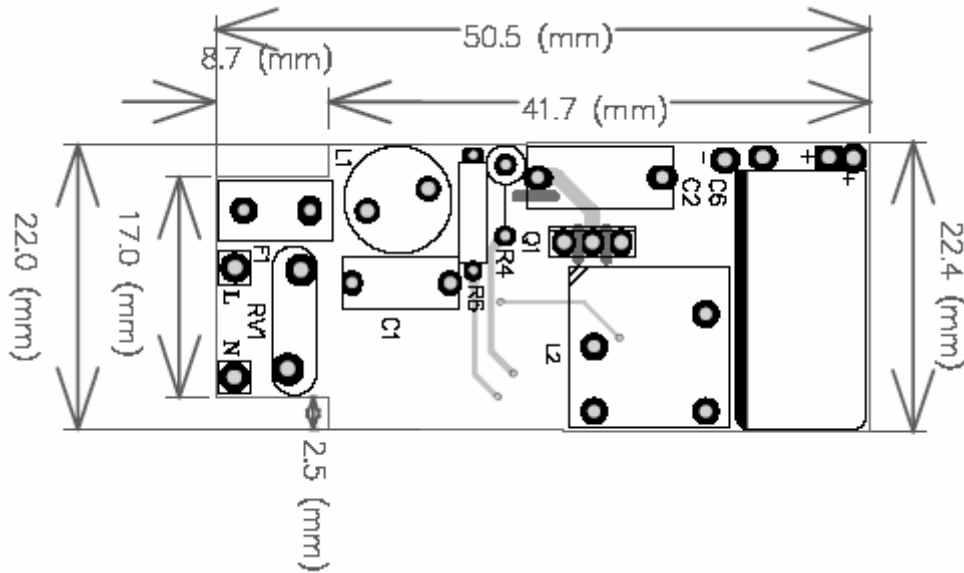

Figure 2 - Top Layer

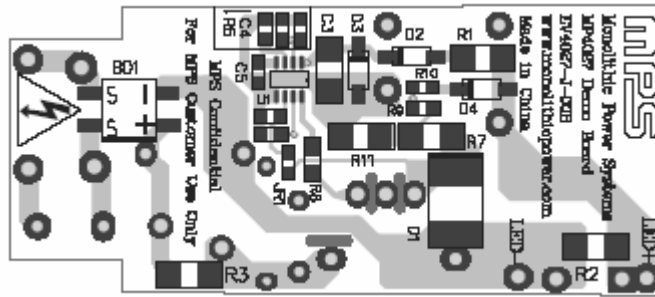

Figure 3 - Bottom Layer

CIRCUIT DESCRIPTION

The EV4027-J-00B is configured in High Side Buck topology with simple schematic, small size and a low cost BOM. It can also achieve high power factor and accurate LED current.

F1, RV1, BD1, L1, C1 and C2 compose the input stage. F1 fuses the AC input to protect for the component failure or some excessive short events. RV1 is used to absorb the high ring voltage of surge test, the diode rectifier BD1 rectifies the input line voltage. L1, C1, R3 and C2 form the EMI filter which can meet the requirement for low line voltage test.. The bulk CBB capacitor C2 is also used for a low impedance path for the switching current, to maintain high power factor, the capacitance of C2 should be selected with low value.

R5, R6, C4 provide sine wave reference for the primary peak current to get an active PFC function. The divided voltage should be lower than the max voltage rating of MULT pin.

R4, C3, D3, D2, R1 are used to supply the power for MP4027. A 4.7 μ F ceramic capacitor C3 is selected to maintain the supply voltage. At start-up, C3 is first charged up by the starter resistor R4 from the line voltage, when the VCC voltage passes the turn on threshold the IC starts to work and the gate begins to switch, then the VCC power supply is taken over by the output cap through R1 and D2. D3 is used to clamp the Vcc voltage in a safe range, as the supply of Vcc is directly from output voltage which is much high than the internal BV of Vcc.

R9, R10, D4 are used to get the inductor current zero crossing signal for realizing the boundary conduction operation, and also monitor the output OVP condition. The OVP voltage is set by the divider ratio of R9, R10. D4 is used to block the negative plateau voltage when MOSFET is turn on.

R7, R11 are sensing resistors for current control and peak current detection. The value of R7, R11 set the output LED current through FB Pin. In Buck solution, the inductor current is always through the sense resistor, so the voltage on ZCD Pin will be added by sense resistor voltage when gate off, it's easy to mis-trigger OVP. Connecting the peak current detection point to

the mid of R7 and R11 can help decrease the mis-trigger of OVP.

L2 is the Buck inductor. Diode D1 rectifies the secondary winding voltage and the capacitor C6 is the output filter. The resistor R2 is placed as pre-load to limit the output voltage rise too high in open load condition.

EV4027-J-00A BILL OF MATERIALS

Qty	Ref	Value	Description	Package	Manufacturer	Manufacturer_P/N
1	BD1	MB6S	BRIDGE, 600V, 0.5A	SOIC-4	Taiwan Semiconductor	MB6S
1	C1	100nF/400V	CBB,400V	DIP	Panasonic	ECQE4104KF
1	C2	220nF/450V	CBB,450V	DIP	Carli	TF224K2Y109L270D9R
1	C3	4.7uF/50V	Ceramic Capacitor,50V	1206	Murata	GRM31CR71H475KA12L
1	C4	3.3nF/50V	Ceramic Cap,50V,X7R	0603	TDK	C1608X7R1H332K
1	C5	2.2uF/6.3V	Ceramic Cap,6.3V,X5R	0603	Murata	GRM188R60J225KE19D
1	C6	100uF/100V	Electrolytic Capacitor,100V	DIP	Jianghai	CD263-100V100
1	D1	STTH3R06U	Diode,3A,600V	SMB	ST	STTH3R06U
2	D2,D4	BAV3004W-7-F	Diode,225mA,300V	SOD-123	Diodes	BAV3004W-7-F
1	D3	BZT52C27	Zener Diode, 27V	SOD-123	Diodes	BZT52C27
1	F1	250V/2A	SS-5-2A	DIP	COOPER BUSSMANN	SS-5-2A
1	L1	1.5mH	Inductor, 1.5mH, 0.21A	DIP	TDK	TSL0808RA-152KR21
1	L2	1.3mH	Buck Inductor	EE13	Emei	FX0332
1	Q1	SMK0460I	SMK0460I	I-PAK	AUK	SMK0460I
2	R1,R3	5.1kΩ	Film RES,1%	1206	Yageo	RC1206FR-075K1L
1	R2	100kΩ	Film RES,1%	1206	Yageo	RC1206FR-07100KL
1	R4	470kΩ	Metal Film RES,1/2W, 1%	DIP	Any	Any
1	R5	10.2kΩ	Film Chip RES, 1%	0603	Yageo	RC0603FR-0710K2L
1	R6	1MΩ	Metal Film RES, 1/4W, 1%	DIP	Any	Any
1	R7	1.8Ω	Thick Film Chip RES, 1%	1206	Yageo	RL1206FR-071R8L
1	R8	20Ω	Thick Film Chip RES, 1%	0805	Yageo	RC0805JR-0720RL
1	R9	2.2kΩ	Thick Film Chip RES, 1%	0603	Yageo	RC0603FR-072K2L
1	R10	39kΩ	Thick Film Chip RES, 1%	0603	Yageo	RC0603FR-0739KL
1	R11	1.1Ω	Thick Film Chip RES, 1%	1206	Yageo	RL1206FR-071R1L
1	RV1	430V/2500A	MOV	DIP	TKS	TVR10431KSY
1	U1	MP4027GJ	Offline LED Lighting Controller	SOT23-8	MPS	MP4027GJ
1	JR1	0Ω	Thick Film Chip RES, 1%	0603	Yageo	RC0603FR-070L

TRANSFORMER SPECIFICATION

Electrical Diagram

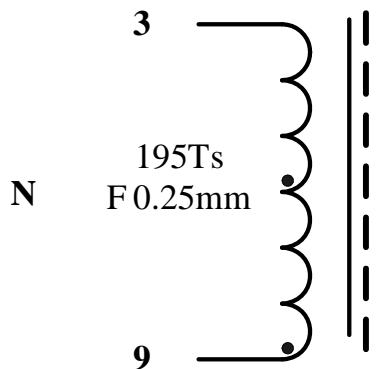

Figure 4 – Transformer Electrical Diagram

Winding Diagram

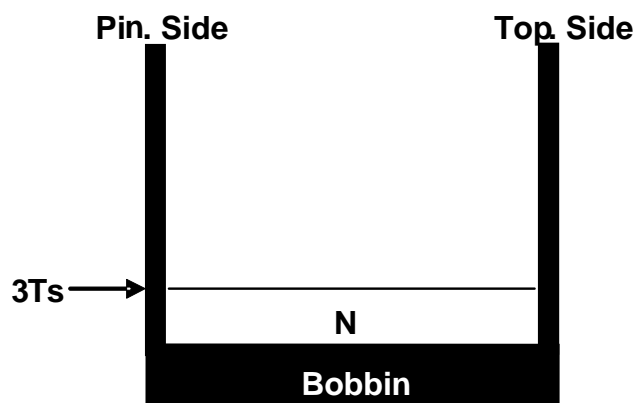

Figure 5 – Winding Diagram

Winding Order

Winding No.	Tape Layer Number	Start & End	Magnet WireΦ(mm)	Turns
N	3	3→9	0.25	195

Electrical Specifications

Inductance	Pins 3- 9, measured at 35kHz	1.3mH±8%
------------	------------------------------	----------

Materials

Item	Description
1	Core: EE13, UI=2500±25%, AL=184.5H/N ² ±3% GAP, ACME P4 or equivalent
2	Bobbin: EE13, 5+5PIN RMMOVE PIN1, 2, 4, 7, 8, 10, 1SECT TH, PM9630 UL94V-0
3	Wire: Φ0.25mm, 2UEW, CLASS B or equivalent
4	Tape: 6.5mm(W)×0.06mm(TH)
5	Tape: 7.7mm(W)×0.06mm(TH)
6	Varnish: JOHN C. DOLPH CO, BC-346A or equivalent
7	Adhesive: 400-36 or equivalent
8	Solder Bar: CHEN NAN: SN99.5/Cu0.5 or equivalent

EVB TEST RESULTS

Performance Data

Vin(V)	Iin(mA)	Pin(W)	Vo(V)	Io(mA)	Po(W)	Efficiency	PF	THD
90	133	11.18	71.7	141	10.11	90.43%	0.929	39.20%
100	118	11.21	71.7	141	10.11	90.18%	0.947	33.30%
110	107	11.26	71.7	142	10.18	90.42%	0.957	29.00%
120	97	11.31	71.7	143	10.25	90.66%	0.963	25.80%
132	89	11.39	71.7	143	10.25	90.02%	0.965	23.40%

Surge Test

Line to Line 500V surge testing was completed according to IEC61547.

Input voltage was set at 115VAC/60Hz. Output was loaded at full load and operation was verified following each surge event.

Surge Level (V)	Input Voltage (VAC)	Injection Location	Injection Phase (°)	Test Result (Pass/Fail)
500	115	L to N	90	Pass
-500	115	L to N	270	Pass

EVB TEST RESULTS

Performance waveforms are tested on the evaluation board.

$I_{LED}=140mA$, $V_{OUT}=72V$, $L_P=1.3mH$, $N =195$

Line/Load Regulation

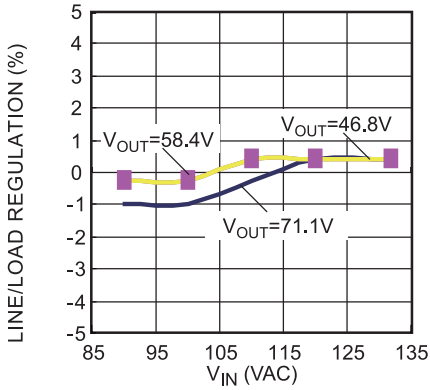

Efficiency

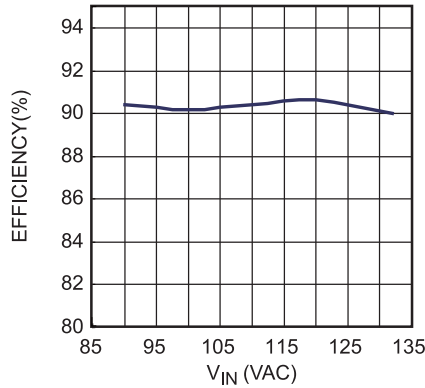

PF @ Full Load

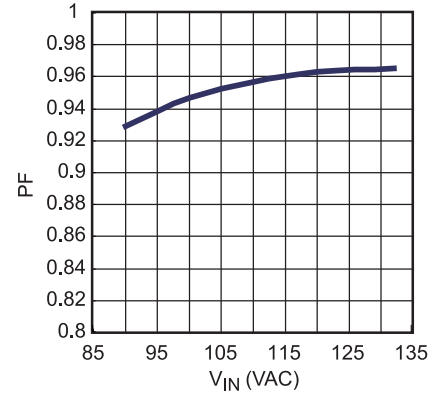

THD @ Full Load

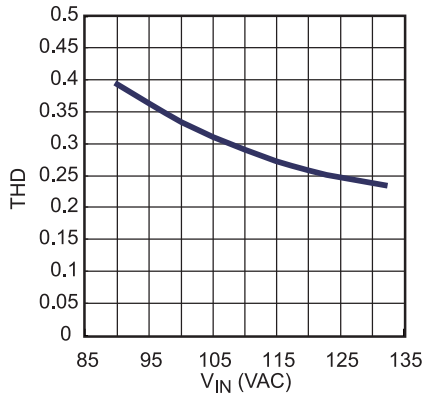

Conduction EMI

$V_{IN}=115V$, Based on L line

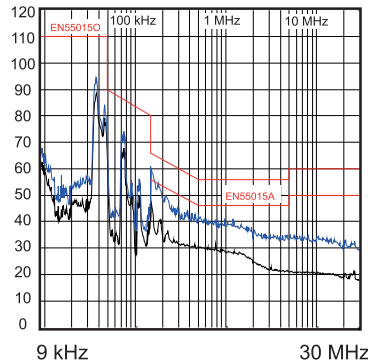

Conduction EMI

$V_{IN}=115V$, Based on N line

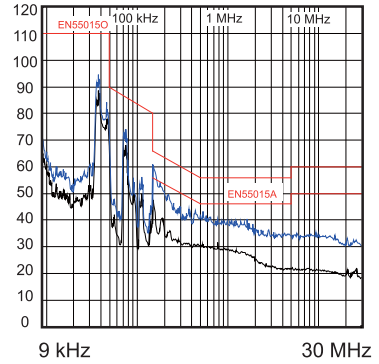

CDN Test

$V_{IN}=115V$, Based on L line

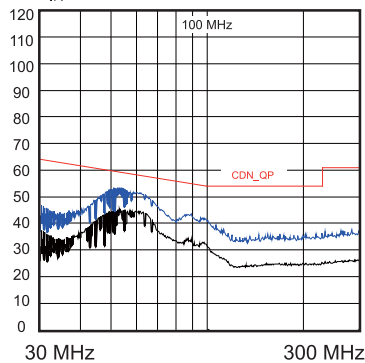

CDN Test

$V_{IN}=115V$, Based on N line

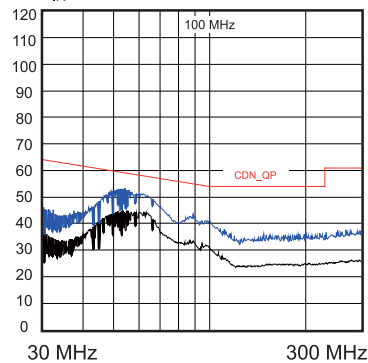

EVB TEST RESULTS *(continued)*

Performance waveforms are tested on the evaluation board.

$I_{LED}=140mA$, $V_{OUT}=72V$, $L_P=1.3mH$, $N=195$

Steady State

$V_{IN}=120V/60Hz$

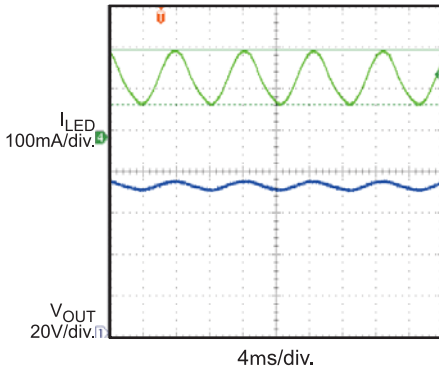

Steady State

$V_{IN}=120V/60Hz$

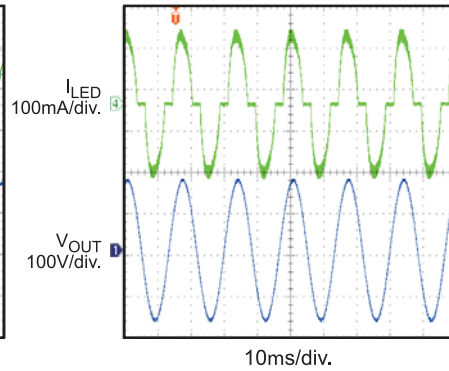

Steady State

$V_{IN}=120V/60Hz$

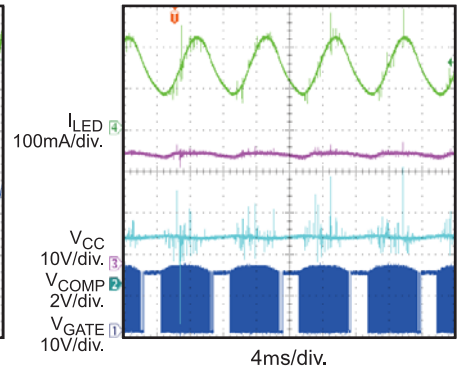

Steady State

$V_{IN}=120V/60Hz$

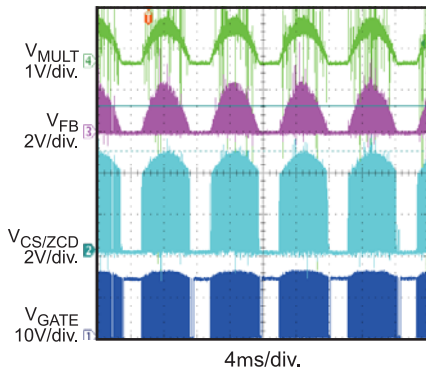

Steady State

$V_{IN}=120V/60Hz$

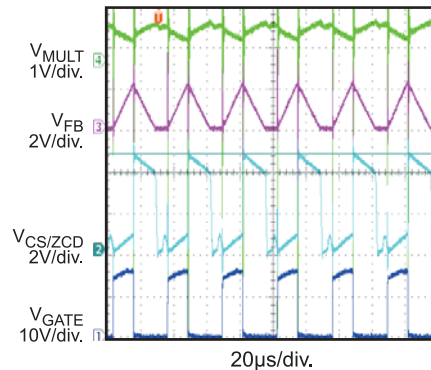

V_{IN} Start up

$V_{IN}=120V/60Hz$

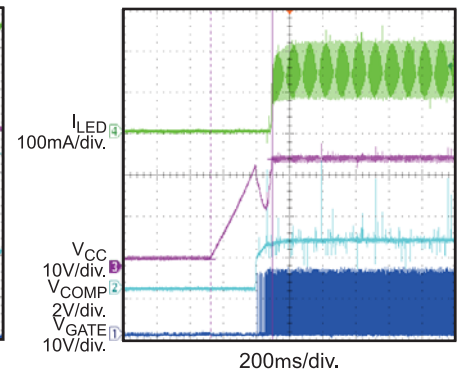

Open LED Protection @Working

$V_{IN}=120V/60Hz$

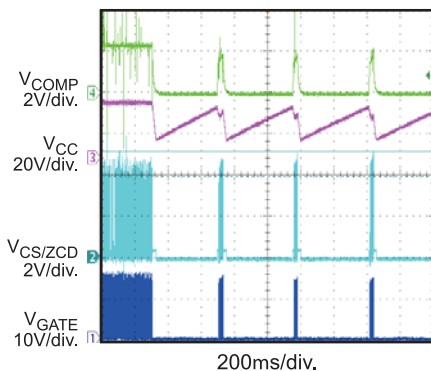

Open LED Protection @Recovery

$V_{IN}=120V/60Hz$

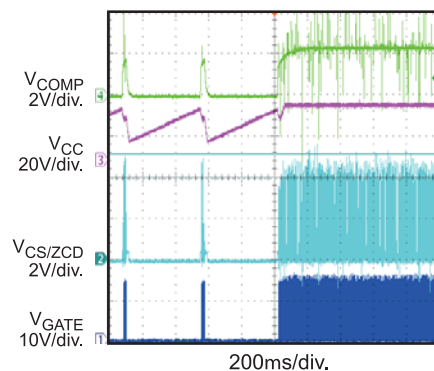

Open LED Protection @Working

$V_{IN}=120V/60Hz$

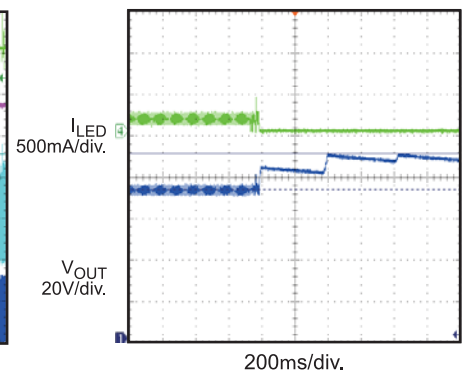

EVB TEST RESULTS *(continued)*

Performance waveforms are tested on the evaluation board.

$I_{LED}=140mA$, $V_{OUT}=72V$, $L_P=1.3mH$, $N =195$

**Open LED Protection
@Recovery**

$V_{IN}=120V/60Hz$

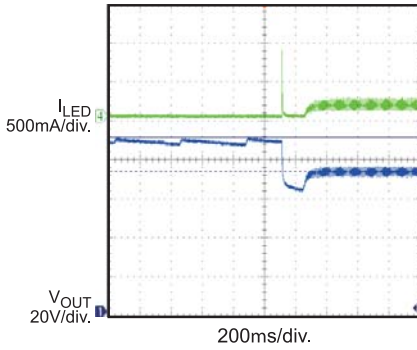

**Short LED Protection
@Working and Recovery**

$V_{IN}=120V/60Hz$

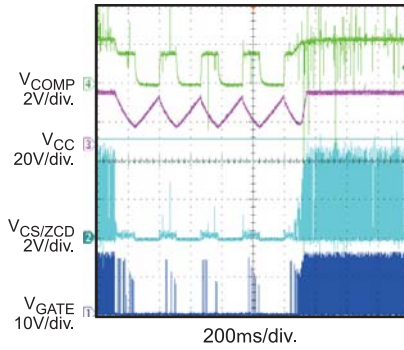

Thermal Test

$V_{IN}=90V$ @Normal Working,
Top Layer

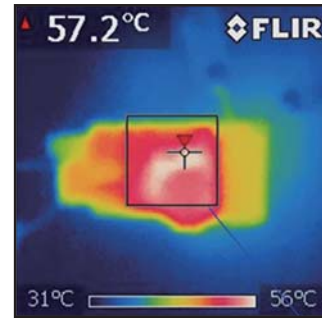

PF Inductor

Thermal Test

$V_{IN}=90V$ @Normal Working,
Bottom Layer

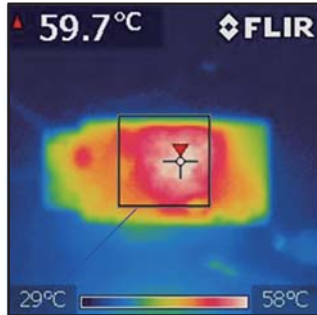

PF Inductor

QUICK START GUIDE

1. Preset AC Power Supply to $90\text{VAC} \leq V_{\text{IN}} \leq 132\text{VAC}$.
2. Turn Power Supply off.
3. Connect the LED string between “LED+” (anode of LED string) and “LED-” (cathode of LED string).
4. Connect Power Supply terminals to AC V_{IN} terminals as shown on the board.
5. Turn AC Power Supply on after making connections.

NOTICE: The information in this document is subject to change without notice. Please contact MPS for current specifications. Users should warrant and guarantee that third party Intellectual Property rights are not infringed upon when integrating MPS products into any application. MPS will not assume any legal responsibility for any said applications.