

DESCRIPTION

The EV3427-L-00A Evaluation Board is designed to demonstrate the performances of MPS' MP3427, which can provide 30W load from Li-on battery input.

The MP3427 is a 600 kHz fixed frequency, high efficiency, wide input range, current mode boost converter with optional internal or external current sensing configuration for high integration or high power application. It features internally a 10mΩ power switch and a synchronous gate driver for high conversion efficiency. The MP3427 is available in a low profile 22-pin 3mmx4mm QFN package.

This board is configured for 8V/30W application.

ELECTRICAL SPECIFICATION

Parameter	Symbol	Value	Units
Supply Voltage	V _{IN}	3 – 5	V
Output Voltage	V _{OUT}	8	V
Output Power	P _{OUT}	0– 30 ⁽¹⁾	W

Notes:

1) The output power may be lower if IC thermal is strictly restricted.

FEATURES

- 3V-to-8V Wide Input Range for MP3427
- Integrated 10mΩ Low-side Power FET
- SDR Driver for Synchronous Solution
- >17A Internal Switch Current Limit
- Optional Internal/External Current Sensing Configuration
- External Soft-Start and Compensation for Higher Flexibility
- Programmable UVLO and Hysteresis
- < 1μA Shutdown Current
- Thermal Shutdown at 150°C
- Available in 3x4mm QFN-22 Package

PACKAGE APPLICATIONS

- Tablet
- Power Banks
- Fuel Cells
- POS Systems
- Electronic Cigarette

All MPS parts are lead-free and adhere to the RoHS directive. For MPS green status, please visit MPS website under Products, Quality Assurance page.

"MPS" and "The Future of Analog IC Technology", are Registered Trademarks of Monolithic Power Systems, Inc.

EV3427-L-00A EVALUATION BOARD



(L × W × H) 6.3cm × 6.3cm × 1.3cm

Board Number	MPS IC Number
EV3427-L-00A	MP3427GL

**Efficiency vs.
Output Current**

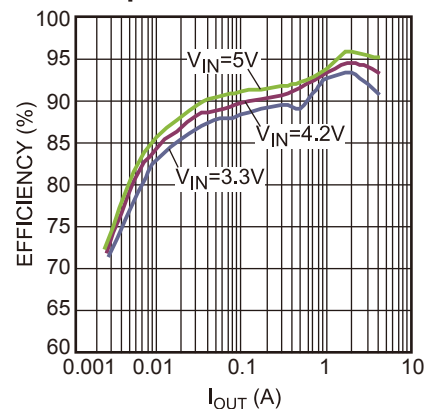

EVALUATION BOARD SCHEMATIC

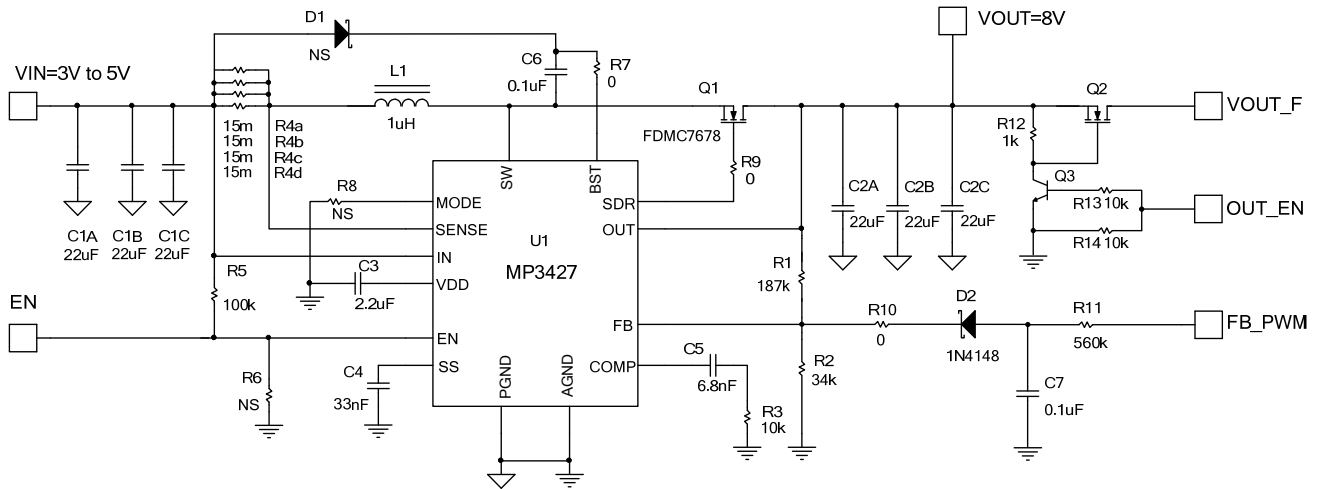

EV3427-L-00A BILL OF MATERIALS

Qty	Ref	Value	Description	Package	Manufacturer	Part Number
6	C1A, C1B, C1C, C2A, C2B, C2C	22µF	16V, ceramic Capacitor	1210	muRata	GRM32ER71C226KEA8L
1	C3	2.2µF	25V, ceramic Capacitor	0805	muRata	GRM21AR71E225KL
1	C4	33nF	50V ceramic capacitor	0603	muRata	GRM188R71H333KL
1	C5	6.8nF	50V ceramic capacitor	0603	muRata	GRM188R71H682KL
2	C6, C7	0.1µF	50V, ceramic Capacitor	0603	muRata	GRM188R71H104KL
1	R1	187k	Film resistor, 1%	0603	YAGEO	RC0603FR-07187KL
1	R2	34k	Film resistor, 1%	0603	YAGEO	RC0603FR-0734KL
3	R3, R13, R14	10k	Film resistor, 1%	0603	YAGEO	RC0603FR-0710KL
4	R4a, R4b, R4c, R4d	15m	low ohmic Film resistor, 1%	0805	YAGEO	RL0805FR-070R015L
1	R5	100k	Film resistor, 5%	0603	YAGEO	RC0603JR-07100KL
0	R6, R8	NS		0603		
3	R7, R9, R10	0	Film resistor, 5%	0603	YAGEO	RC0603JR-070RL
1	R11	560k	Film resistor, 1%	0603	YAGEO	RC0603FR-07560KL
1	R12	1k	Film resistor, 1%	0603	YAGEO	RC0603FR-071KL

EV3427-L-00A BILL OF MATERIALS

Qty	Ref	Value	Description	Package	Manufacturer	Part Number
0	D1	NS		SOD-323		
1	D2	1N4148	DIODE	SOD-123		1N4148
1	L1	1 μ H	4.6mOhm, Isat=19A, inductor	SMD	Wurth	744311100
1	Q1	FDMC7678	30V, 6.8mOhm 15A, N- Channel MOS	MLP3.3x3.3	FAIRCHILD	FDMC7678
1	Q2	AON7423	20V, P-Channel MOS	QFN3.3x3.3	ALPHA&OMEGA	AON7423
1	Q3	MMBT3904	NPN	SOT23	NXP	MMBT3904
1	U1	MP3427	3~8V, 17A, 600kHz boost converter	QFN22-3*4	MPS	MP3427GL

EVB TEST RESULTS

Performance waveforms are tested on the evaluation board.

$V_{IN} = 3.3V$, $V_{OUT} = 8V$, $P_{OUT}=30W$, $L = 1\mu H$, $T_A = 25^\circ C$, $MODE=float$, $R_{SENSE}=3.75m\Omega$, unless otherwise noted.

Efficiency vs. Output Current

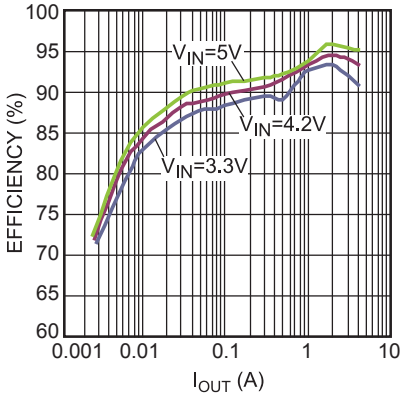

Load Regulation

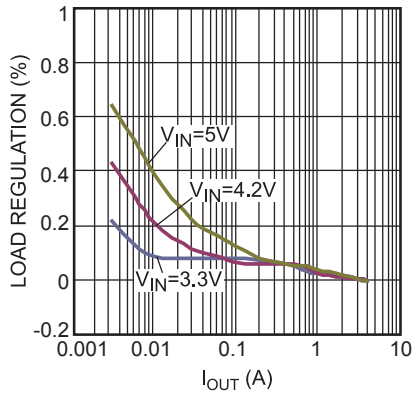

Line Regulation

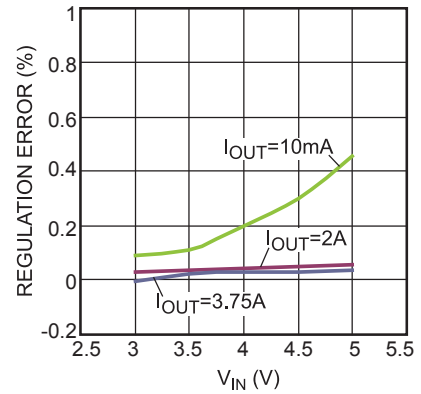

Case Temperature Rise vs. Output Current

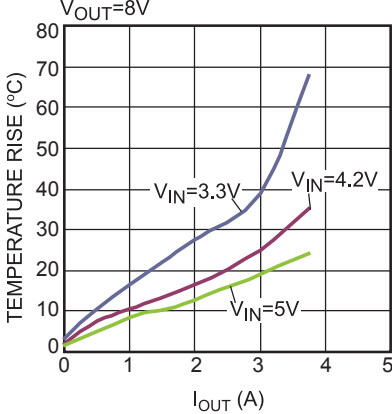

Bode Plot

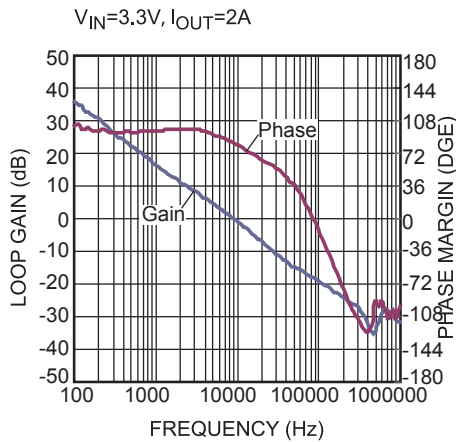

Bode Plot

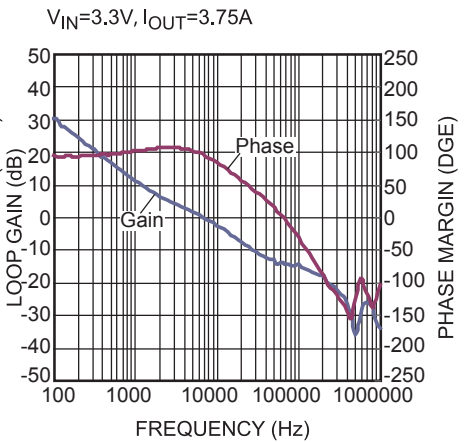

EVB TEST RESULTS (continued)

Performance waveforms are tested on the evaluation board.

$V_{IN} = 3.3V$, $V_{OUT} = 8V$, $P_{OUT} = 30W$, $L = 1\mu H$, $T_A = 25^\circ C$, $MODE = float$, $R_{SENSE} = 3.75m\Omega$, unless otherwise noted.

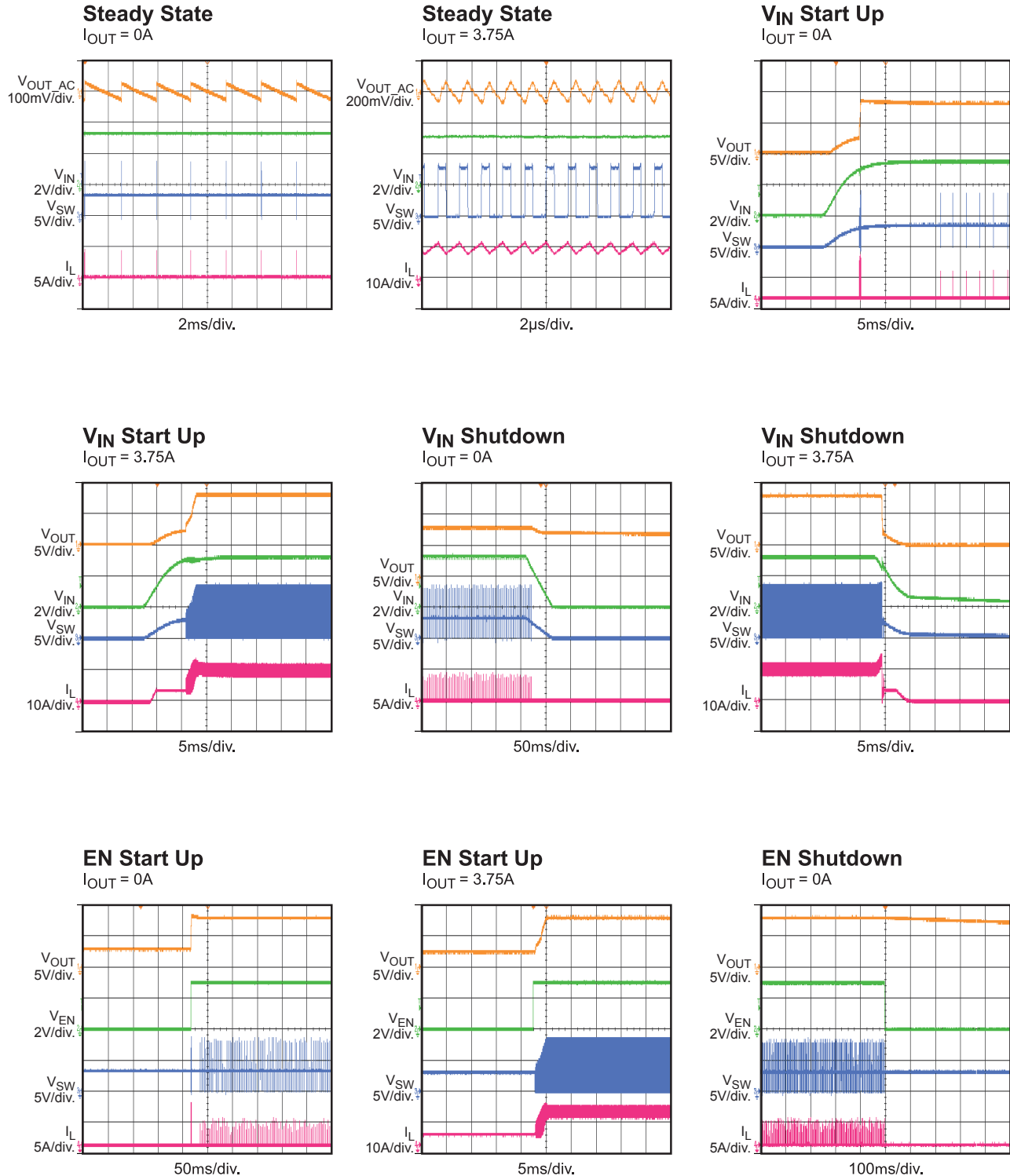

EVB TEST RESULTS (continued)

Performance waveforms are tested on the evaluation board.

$V_{IN} = 3.3V$, $V_{OUT} = 8V$, $P_{OUT}=30W$, $L = 1\mu H$, $T_A = 25^\circ C$, $MODE=float$, $R_{SENSE}=3.75m\Omega$, unless otherwise noted.

EN Shutdown

$I_{OUT} = 3.75A$

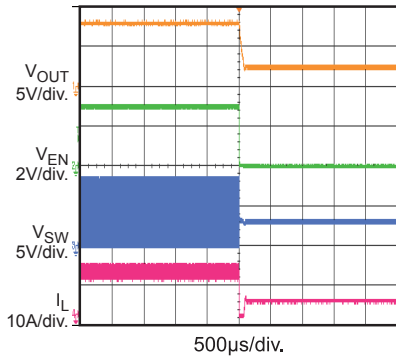

Load Transient

$I_{OUT} = 0.5A$ to $2A$, $15mA/\mu s$

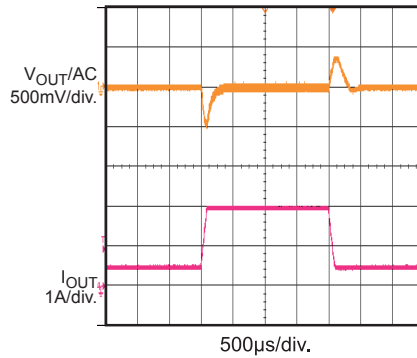

Load Transient

$I_{OUT} = 2A$ to $3.75A$, $15mA/\mu s$

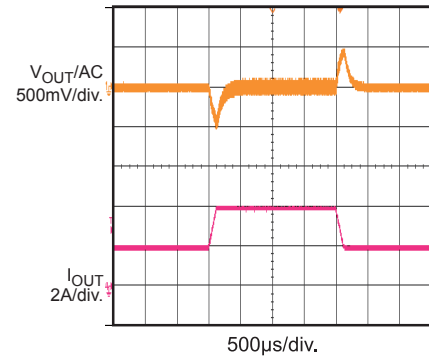

FB Regulate On

$FB_PWM=5V$, $I_{OUT} = 0A$

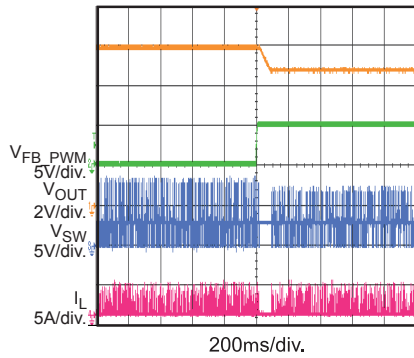

FB Regulate On

$FB_PWM=5V$, $I_{OUT} = 3.75A$

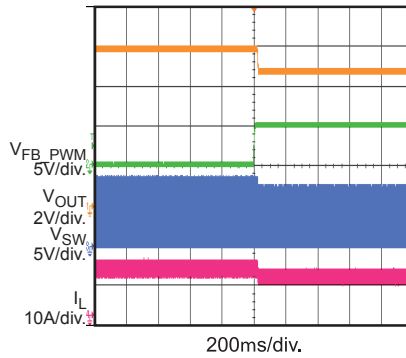

FB Regulate Off

$FB_PWM=5V$, $I_{OUT} = 0A$

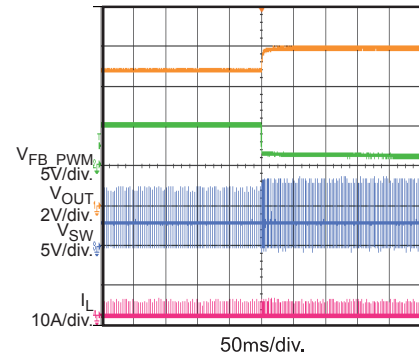

FB Regulate Off

$FB_PWM=5V$, $I_{OUT} = 3.75A$

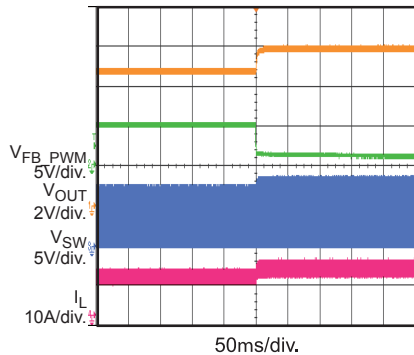

OUT_EN On/Off

$I_{OUT} = 0A$, $I_{OUT_F} = 0A$,

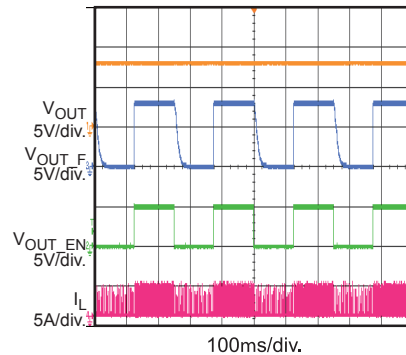

OUT_EN On/Off

$I_{OUT} = 2A$, $I_{OUT_F} = 2A$,

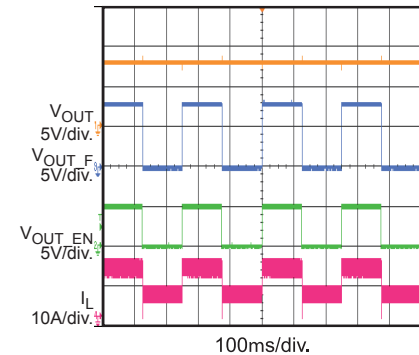

PRINTED CIRCUIT BOARD LAYOUT

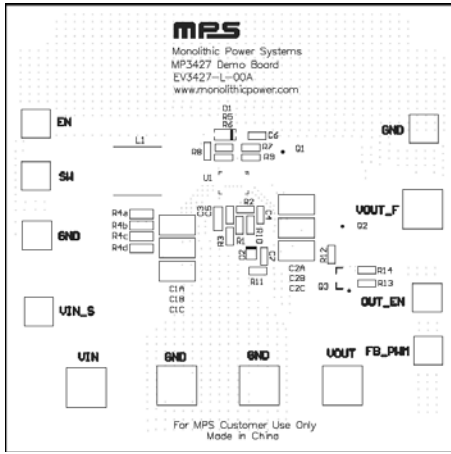

Figure 1: Top Silkscreen Layer

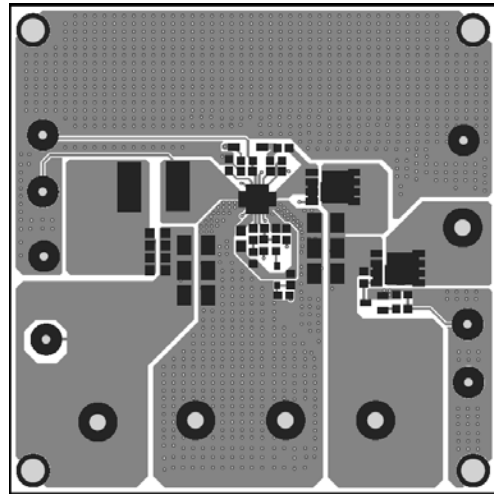

Figure 2: Top Layer

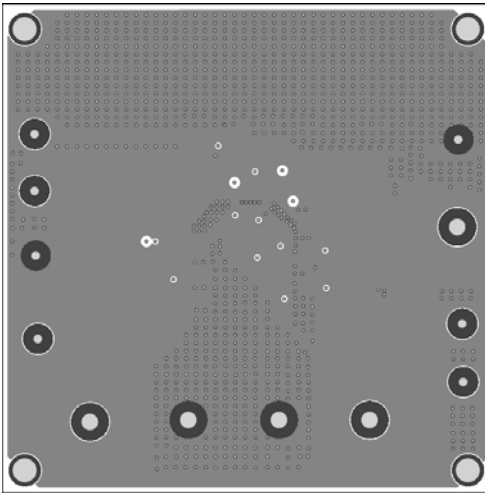

Figure 3: Middle Layer 1

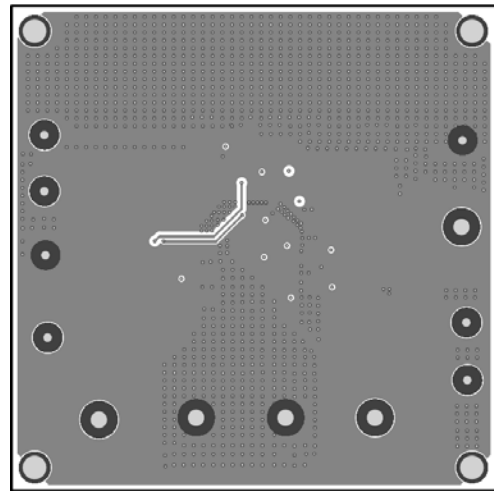

Figure 4: Middle Layer 2

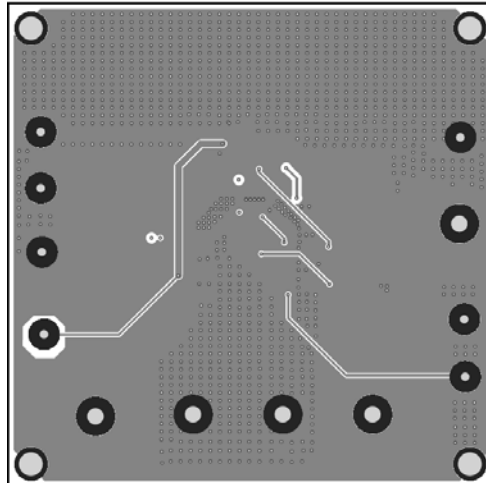

Figure 5: Bottom Layer

QUICK START GUIDE

The output voltage of this board is set to 8V. The board layout accommodates most commonly used inductors and output capacitors. With an input ranging from 3V to 5V, this board can provide load up to 30W. To use this EVB for evaluation, you can do as below:

1. Preset Power Supply to between 3V and 5V.
2. Turn Power Supply off.
3. Preset Load to a value, for example, 1.5A.
4. Connect Power Supply terminals to:
 - a. Positive (+): VIN
 - b. Negative (-): GND
 - c. Connect Load to:
 - d. Positive (+): VOUT
 - e. Negative (-): GND
5. Turn Power Supply on after making connections. The MP3427 will automatically startup to work.

The output voltage V_{OUT} can be programmed by changing R2. And the value of R2 can be calculated by the following formula:

$$R2 = R1 \times \frac{V_{FB}}{V_{OUT} - V_{FB}}$$

Where R1=187kΩ, and V_{FB}=1.225V.

If EN function is preferred, apply a high level (>1.39V) turns on MP3427, low level (<0.4V) turns off MP3427. After being turned off, output voltage will be discharged to equal to V_{in}.

If FB_PWM function is use to regulate the output voltage, FB_PWM value and R11 for expected V_{OUT} can be calculated by the below formula:

$$V_{FB_PWM} = \left(\frac{V_{FB}}{R2} - \frac{V_{OUT} - V_{FB}}{R1} \right) \times R11 + V_{FB} + V_F$$

Where, V_F is the DIODE forward voltage. The V_{FB-PWM} control voltage can be provided by a DC voltage source or a PWM voltage source.

If OUT_EN function is used, different OUT_EN signal duty cycle can get different average power on the resistive load.

The default configuration of this board is using external sensing resistor. To use the internal sensing block, first shut off power supply, then connect MODE pin (find it by looking for R8 on the board) to GND through R8 of which the value should be 0Ω. After power-on, MP3427 automatically uses internal sensing resistor.

NOTICE: The information in this document is subject to change without notice. Please contact MPS for current specifications. Users should warrant and guarantee that third party Intellectual Property rights are not infringed upon when integrating MPS products into any application. MPS will not assume any legal responsibility for any said applications.