

### DESCRIPTION

EV3421-G-00A Evaluation Board is designed to demonstrate the capability of MP3421. MP3421 is a high-efficiency, synchronous, current-mode, step-up converter with output disconnect.

The MP3421 can provide inrush current limiting and output short-circuit protection. It can work with an input voltage as low as 1.9V. The integrated P-channel synchronous rectifier improves efficiency and eliminates the need for an external Schottky diode. The PMOS disconnects the output from the input when the part shuts down.

The 600kHz switching frequency allows for small external components, while the internal compensation and soft-start minimize the external component count. The MP3421 is available in 14-pin QFN 2mmx2mm package.

### ELECTRICAL SPECIFICATION

Parameter	Symbol	Value	Units
Input Voltage	$V_{IN}$	2.8 – 4.2 <sup>(1)</sup>	V
Output Voltage	$V_{OUT}$	5	V
Output Current	$I_{OUT}$	0 – 2.1	A

### FEATURES

- 1.9V to 5.5V Input Work Range
- 2.5V to 5.5V Output Range
- Internal Synchronous Rectifier
- 600kHz Fixed Frequency Switching
- >5.5A Switch Current Limit Capability
- 43uA Quiescent Current
- High Efficiency over Full Load Range
- Internal Soft-start and Compensation
- True Output Load Disconnect from Input
- OCP, SCP, OVP and OTP Protection
- Small QFN2x2-14 Package

### APPLICATIONS

- Battery-Powered Products
- Power Banks, Juice Packs, Battery Back-up Units
- USB Power Supply
- Consumer Electronic Accessories
- Tablets

All MPS parts are lead-free and adhere to the RoHS directive. For MPS green status, please visit MPS website under Products, Quality Assurance page.

“MPS” and “The Future of Analog IC Technology”, are Registered Trademarks of Monolithic Power Systems, Inc.

**Note:**

1) This board can supply 5V/2.1A load from 2.8V-4.2V input power, it can work with lower than 2.8V input but the load capability is lower than 2.1A, it can work with higher than 4.2V input but it may trigger down mode with high power-loss when  $V_{IN}$  is close to  $V_{OUT}$ .

### EV3421-G-00A EVALUATION BOARD



(L x W x H) 6.35cm x 6.35cm x 0.6cm	
Board Number	MPS IC Number
EV3421-G-00A	MP3421GG

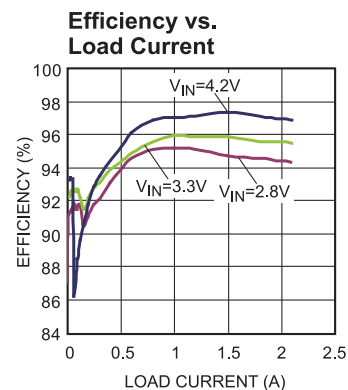

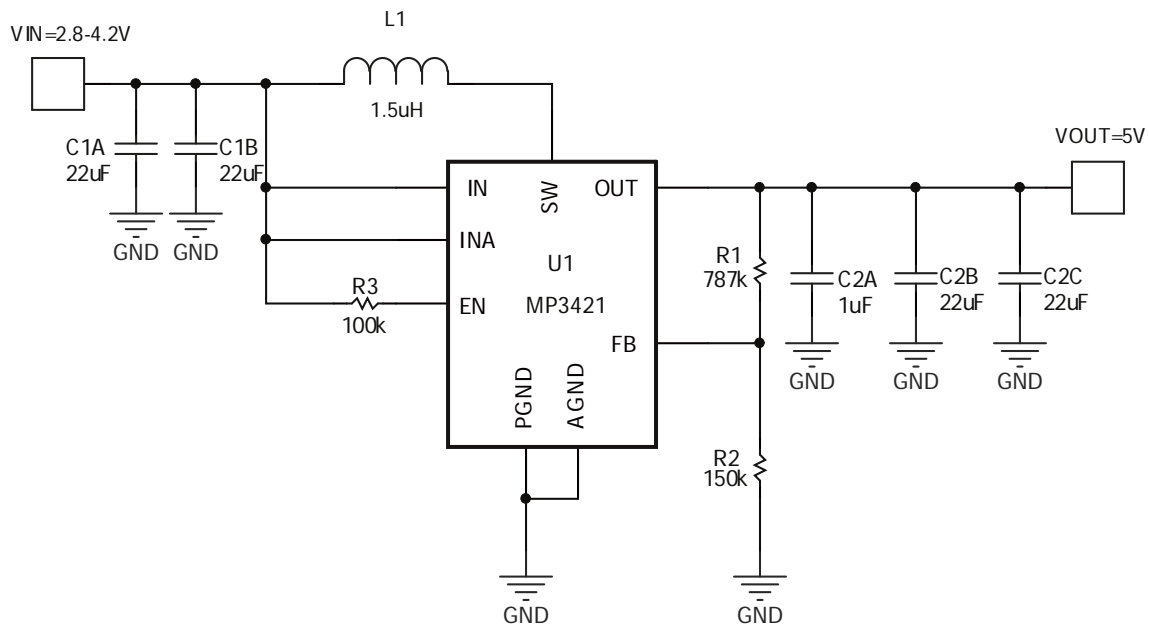
**EVALUATION BOARD SCHEMATIC (2)(3)(4)**

**Notes:**

- 2) INA pin needs short to VIN.
- 3) It is strongly recommended control IC on/off through EN pin.
- 4) It is optimized for typical 5V output with 1.5μH inductor, the feedback compensation may need change for other output voltage or other inductance.

**EV3421-G-00A BILL OF MATERIALS**

Qty	Ref	Value	Description	Package	Manufacturer	Part Number
4	C1A, C1B, C2B, C2C	22μF	Ceramic Cap, 10V,X7R	1210	Murata	GRM32ER71A226KE20L
1	C2A	1μF	Ceramic Cap,10V,X5R	0603	Murata	GRM188R61A105KA61D
1	L1	1.5μH	RDC=6.6mΩ, IR=11A,Isat=14A,	SMD	Würth	744311150
1	R1	787kΩ	Film Res,1%	0603	YAGEO	RC0603FR-07787KL
1	R2	150kΩ	Film Res,1%	0603	ROYAL	RL0603FR-07150KL
1	R3	100kΩ	Film Res,1%	0603	ROYAL	RL0603FR-07100KL
1	U1	MP3421	5.5A Synchronous Step-up Converter with Output Disconnect	QFN-14 2mmx2mm	MPS	MP3421GG

## EVB TEST RESULTS

Performance waveforms are tested on the evaluation board.

$V_{IN} = 3.3V$ ,  $V_{OUT} = 5V$ ,  $L = 1.5\mu H$ ,  $T_A = 25^\circ C$ , unless otherwise noted.

**Efficiency vs. Load Current**

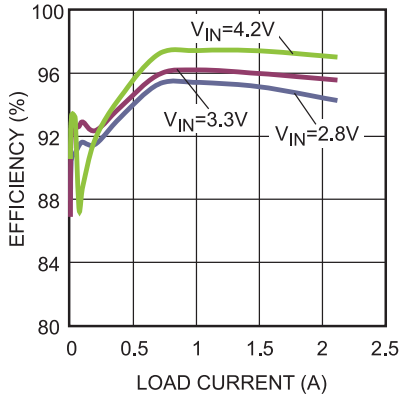

**Case Temperature Rising vs. Load Current**

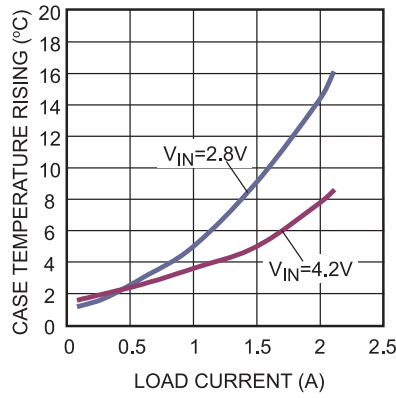

**Line Regulation**

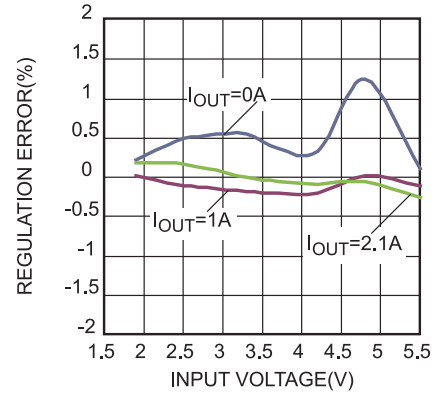

**Load Regulation**

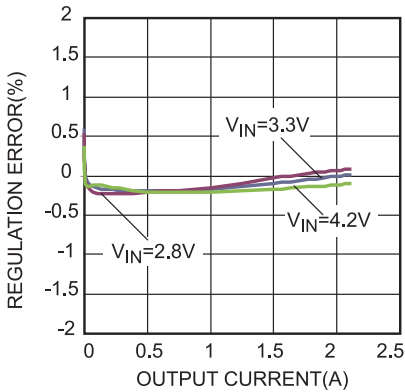

**Bode Plot**

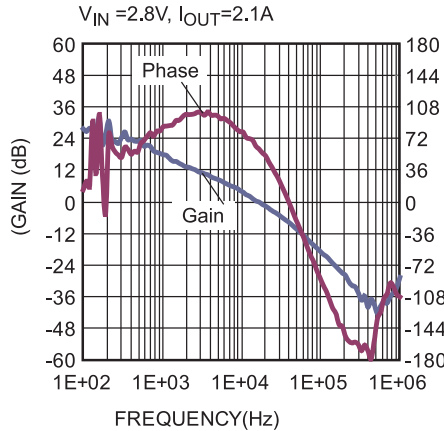

**Bode Plot**

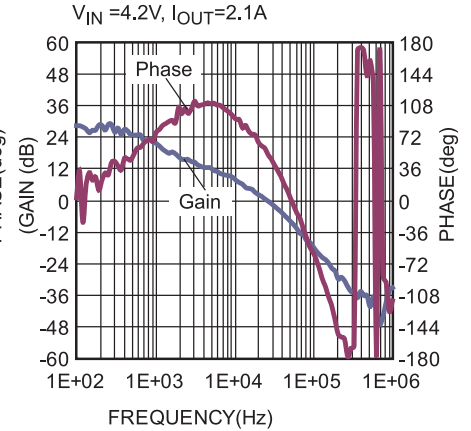

## EVB TEST RESULTS (continued)

Performance waveforms are tested on the evaluation board.

$V_{IN} = 3.3V$ ,  $V_{OUT} = 5V$ ,  $L = 1.5\mu H$ ,  $T_A = 25^\circ C$ , unless otherwise noted.

**Output Voltage Ripple**

$I_{OUT} = 0A$

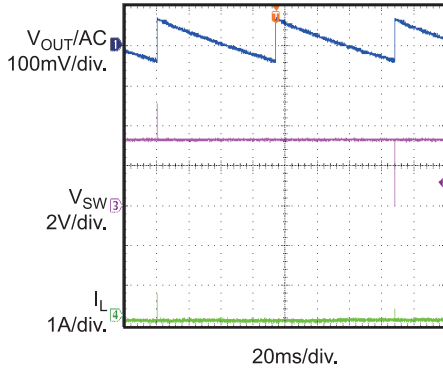

**Output Voltage Ripple**

$I_{OUT} = 0.1A$

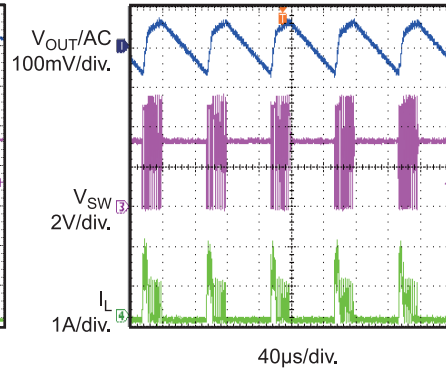

**Output-Voltage Ripple**

Load = 2.1A

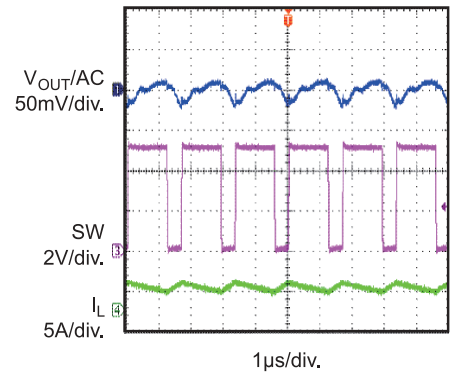

**V<sub>IN</sub> Startup**

$I_{OUT} = 0A$

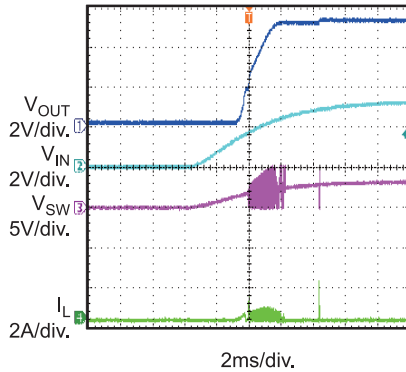

**V<sub>IN</sub> Startup**

$R_{LOAD} = 3.5\Omega$

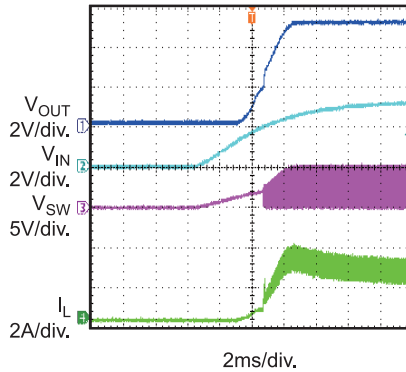

**V<sub>IN</sub> Shutdown**

$I_{OUT} = 0.01A$

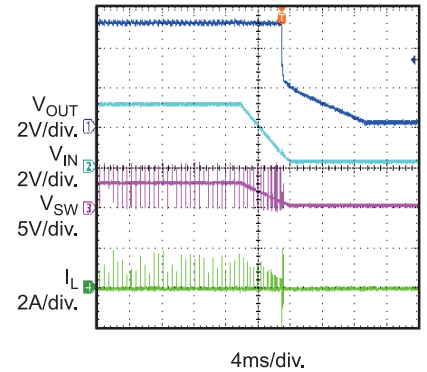

**V<sub>IN</sub> Shutdown**

$R_{LOAD} = 3.5\Omega$

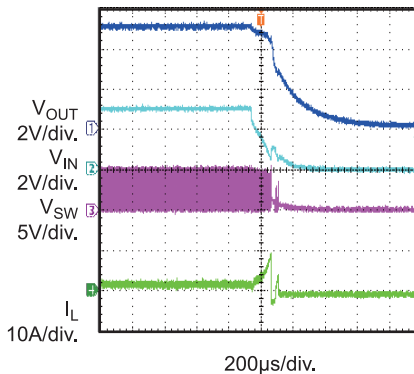

**EN Startup**

$I_{OUT} = 0A$

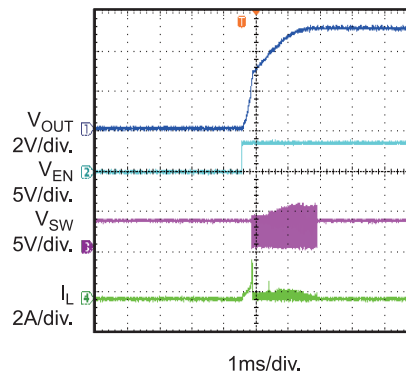

**EN Startup**

$R_{LOAD} = 3.5\Omega$

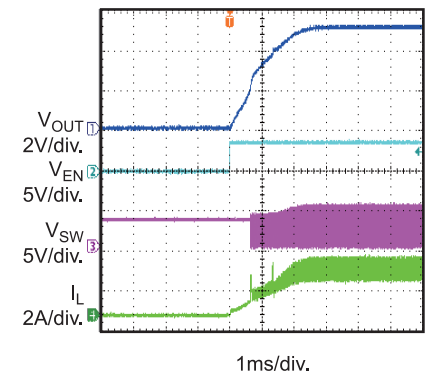

## EVB TEST RESULTS (continued)

Performance waveforms are tested on the evaluation board.

$V_{IN} = 3.3V$ ,  $V_{OUT} = 5V$ ,  $L = 1.5\mu H$ ,  $T_A = 25^\circ C$ , unless otherwise noted.

### EN Shutdown

$I_{OUT} = 0.01A$

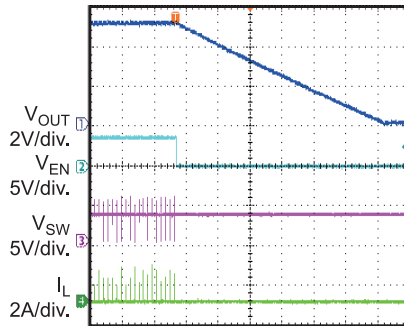

4ms/div.

### EN Shutdown

$R_{LOAD} = 3.5\Omega$

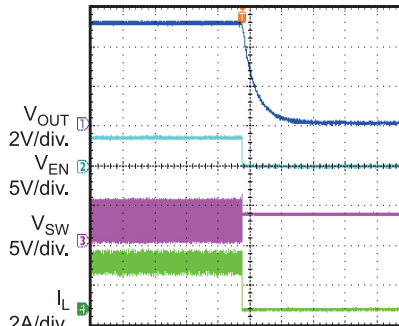

400μs/div.

### Load Transient Response

Load = 0.01A → 1A @ 100mA/μs

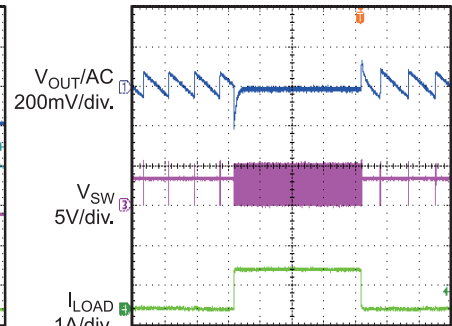

1ms/div.

### Load Transient Response

Load = 1A → 2A @ 100mA/μs

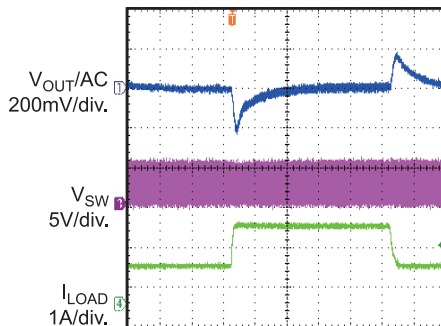

100μs/div.

### Short Circuit Entry

$V_{IN} = 4.2V$ ,  $I_{OUT} = 0.5A$

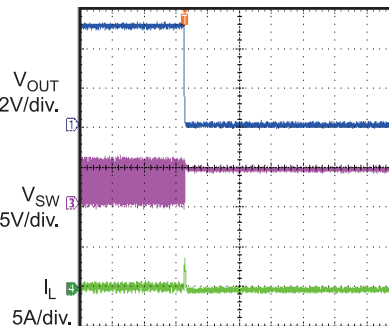

200μs/div.

### Short Circuit Recovery

Recovers to 0.1A Load

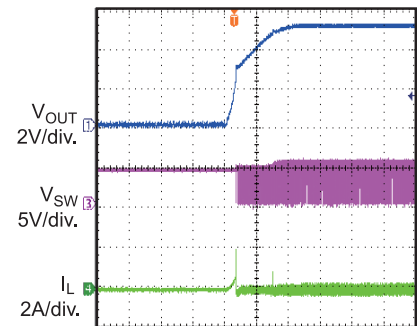

1ms/div.

## PRINTED CIRCUIT BOARD LAYOUT

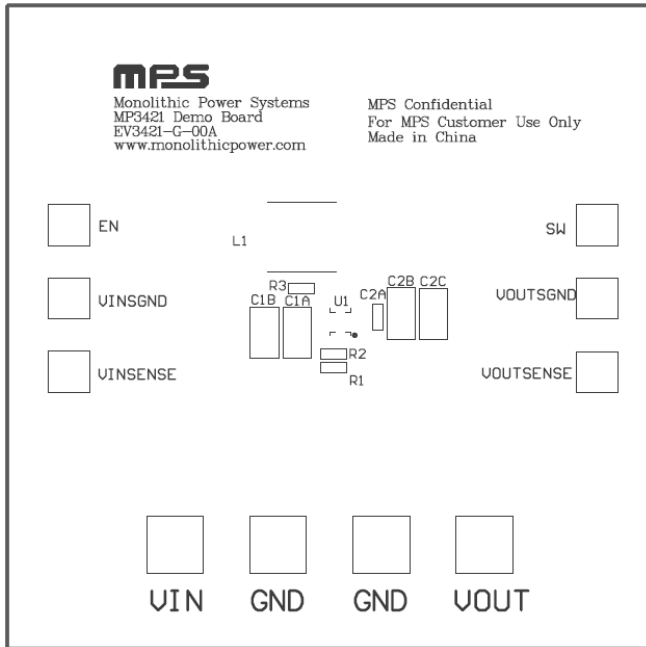

Figure 1—Top Silk Layer

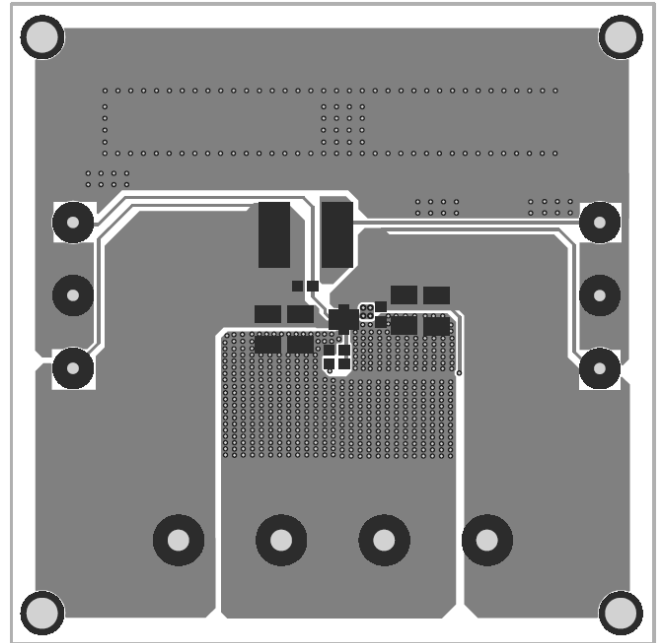

Figure 2—Top Layer

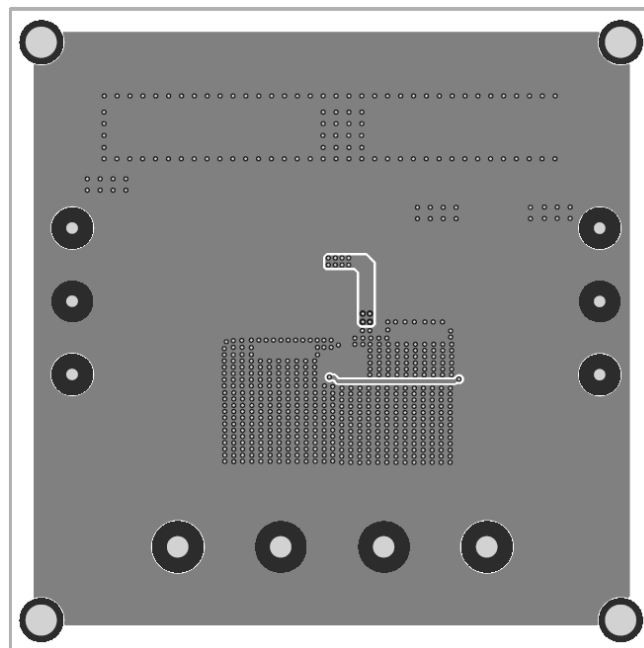

Figure 3—Bottom Layer

## QUICK START GUIDE

The output voltage of this board is set to 5V. The board layout accommodates most commonly used components.

1. Preset Power Supply to  $2.8V \leq V_{IN} \leq 4.2V$ .
2. Turn Power Supply off.
3. Connect Power Supply terminals to:
  - a. Positive (+): VIN
  - b. Negative (-): GND
4. Connect Load to:
  - a. Positive (+): VOUT
  - b. Negative (-): GND
5. Turn Power Supply on after making connections.
6. The MP3421 is enabled on the evaluation board once VIN is applied.
7. The output voltage VOUT can be changed by varying R2. Calculate the new value using the formula:

$$V_{out} = V_{FB} \times \frac{R1+R2}{R2}$$

Where  $V_{FB} = 0.807V$  and  $R1=787k\Omega$ .

8. To use the Enable function, apply a digital input to the EN pin. Drive EN higher than 1.2V to turn on MP3421 or less than 0.4V to turn it off.

**NOTICE:** The information in this document is subject to change without notice. Please contact MPS for current specifications. Users should warrant and guarantee that third party Intellectual Property rights are not infringed upon when integrating MPS products into any application. MPS will not assume any legal responsibility for any said applications.