

## DESCRIPTION

EV3416-J-00A evaluation board is designed to demonstrate the capability of MP3416. The MP3416 is a 1.1A switching current, low quiescent current, step-up converter with output disconnect.

The MP3416 works in peak current control mode, providing good transient response. The integrated P-channel synchronous rectifier improves efficiency and eliminates the need for an external schottky diode.

The device enters pulse skip mode to save power loss in light load condition. When the part shuts down, the output is disconnected from input, allowing the part to draw less than 0.65µA in shutdown mode. The MP3416 is available in a small 8-pin TSOT23 package.

## Electrical Specification

Parameter	Symbol	Value	Units
Input Voltage	V <sub>IN</sub>	0.86-5.5	V
Startup Voltage	V <sub>START</sub>	1.25-5.5	V
Output Voltage	V <sub>OUT</sub>	3.3	V

## FEATURES

- Input voltage range: 0.86V to 5.5V
- Startup voltage range: 1.25V to 5.5V
- Output voltage range: 1.8V to 5.5V
- 9.5µA quiescent current
- < 650nA shutdown current
- Up to 80% efficiency at 100µA-200µA light load condition
- Output disconnect in shutdown
- Down mode when V<sub>IN</sub> > V<sub>OUT</sub>
- Adjustable low battery detection
- Internal synchronous rectifier
- Over-temperature protection with thermal shutdown at 155°C
- TSOT23-8 Package

## APPLICATIONS

- Medical Devices
- Digital Retail Displays
- Gaming Controllers
- Remote Controls
- Battery-Powered Products
- Handheld Computers and Smart phones

All MPS parts are lead-free, halogen free, and adhere to the RoHS directive. For MPS green status, please visit MPS website under Quality Assurance.

"MPS" and "The Future of Analog IC Technology" are Registered Trademarks of Monolithic Power Systems, Inc.

## EV3416-J-00A EVALUATION BOARD



(L x W x H) 6.35cm x 6.35cm x XXX cm

Board Number	MPS IC Number
EV3416-J-00A	MP3416GJ

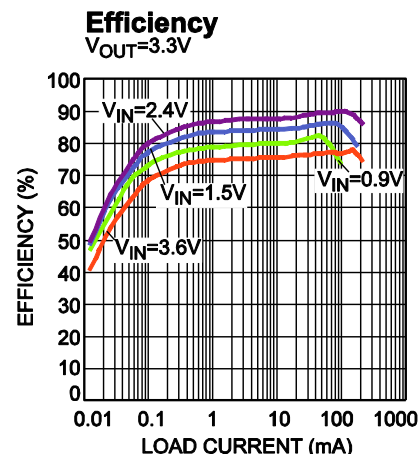

## EVALUATION BOARD SCHEMATIC

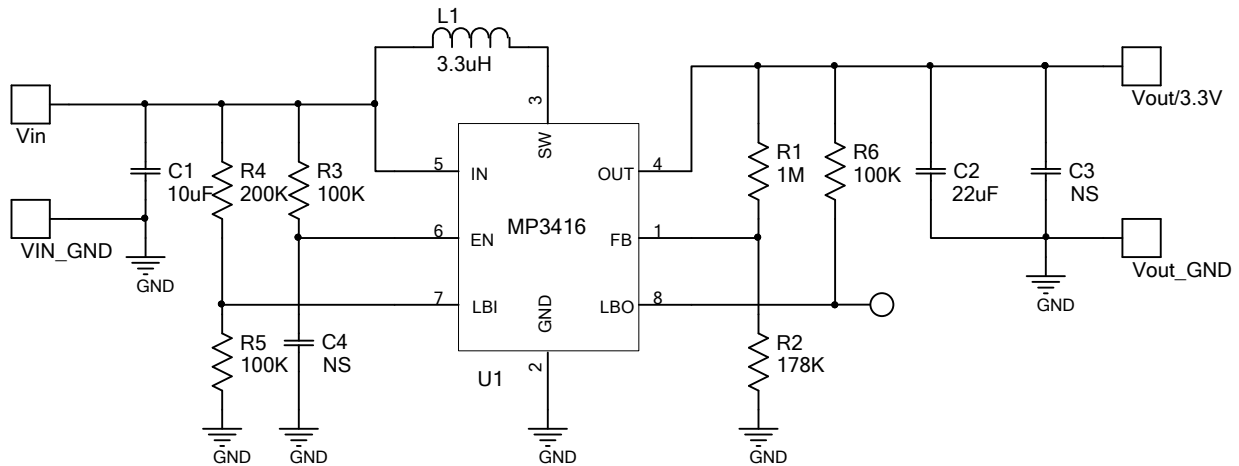

## EV3416-J-00A BILL OF MATERIALS

Qty	Ref	Value	Description	Package	Manufacturer	Part Number
1	C1	10µF	10V, Ceramic Capacitor	0805	muRata	GRM219R61A106KE44D
1	C2	22µF	6.3V, Ceramic Capacitor	0805	muRata	GRM21BR60J226ME39L
2	C3,C4	NS				
1	L1	3.3µH	$I_{SAT}=1.8A$ , $RDC=65m\Omega$		Würth	744042003
1	R1	1M	Film resistor, 1%	0603	Yageo	RC0603FR-071ML
1	R2	178k	Film resistor, 1%	0603	Yageo	RC0603FR-07178KL
3	R3, R5, R6	100k	Film resistor, 1%	0603	Yageo	RC0603FR-07100KL
1	R4	200k	Film resistor, 1%	0603	Yageo	RC0603FR-07200KL
1	U1	MP3416	Boost Converter	TSOT23-8	MPS	MP3416GJ-Z

## EV BOARD TEST RESULTS

$V_{IN} = 1.8V$ ,  $V_{OUT} = 3.3V$ ,  $L = 3.3 \mu H$ ,  $T_A = 25^\circ C$ , unless otherwise noted.

### Efficiency

$V_{OUT}=3.3V$

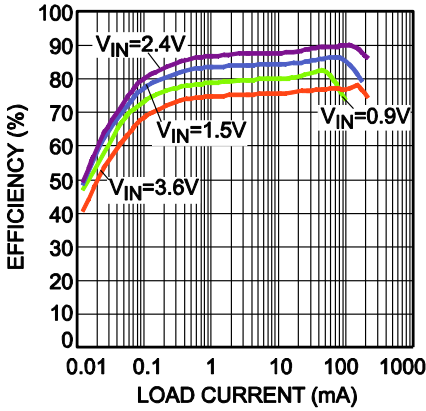

### Load Regulation

$V_{OUT}=3.3V$

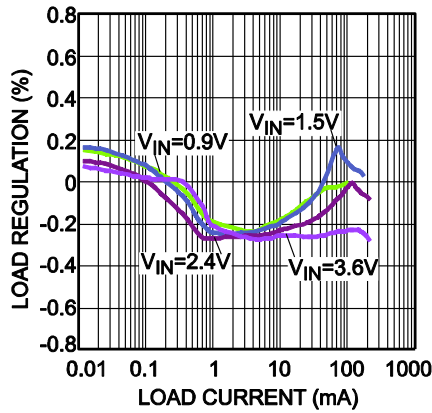

### Line Regulation

$V_{OUT}=3.3V$ ,  $I_{OUT}=100mA$

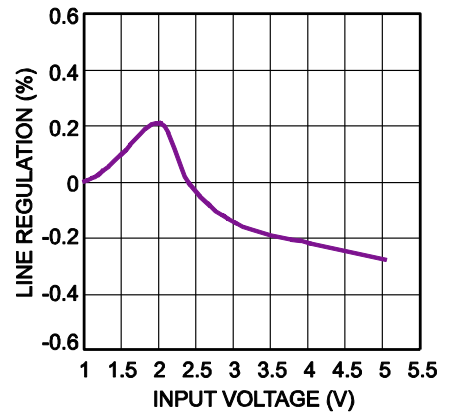

### SW Frequency vs. Load Current

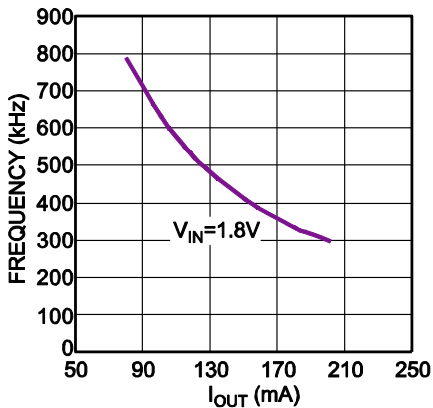

### Case Temperature Rise vs. Output Current

$V_{OUT}=3.3V$

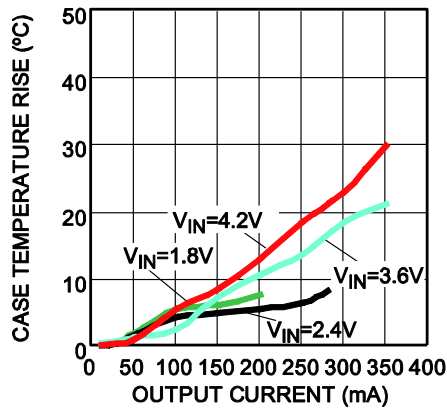

## EVB TEST RESULTS *(continued)*

$V_{IN} = 1.8V$ ,  $V_{OUT} = 3.3V$ ,  $L = 3.3\mu H$ ,  $T_A = 25^\circ C$ , unless otherwise noted.

### Output Ripple

$I_{OUT} = 0A$

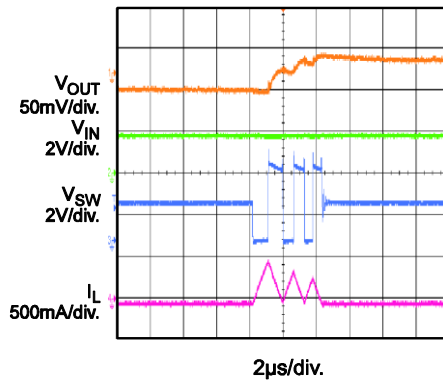

### Output Ripple

$I_{OUT} = 0.2A$

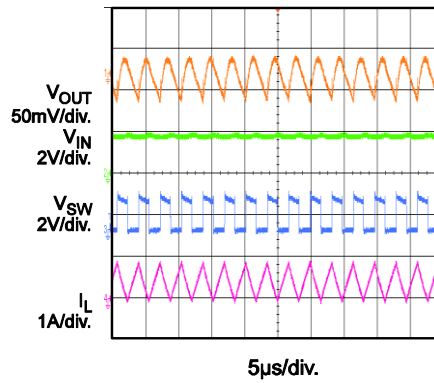

### V<sub>IN</sub> Startup

$I_{OUT} = 0A$

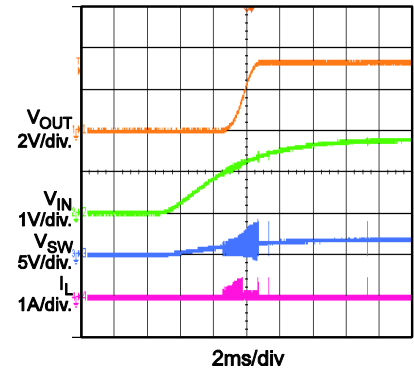

### V<sub>IN</sub> Startup

$I_{OUT} = 0.2A$

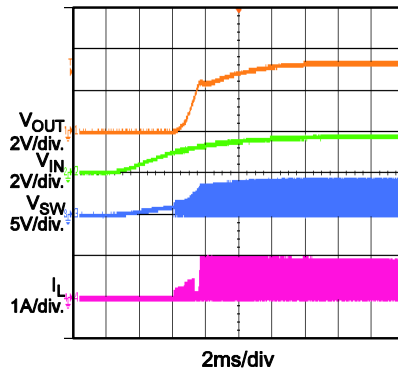

### V<sub>IN</sub> Shutdown

$I_{OUT} = 0A$

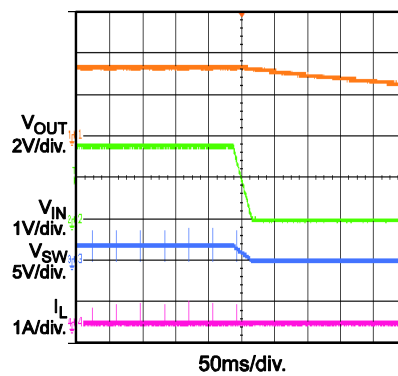

### V<sub>IN</sub> Shutdown

$I_{OUT} = 0.2A$

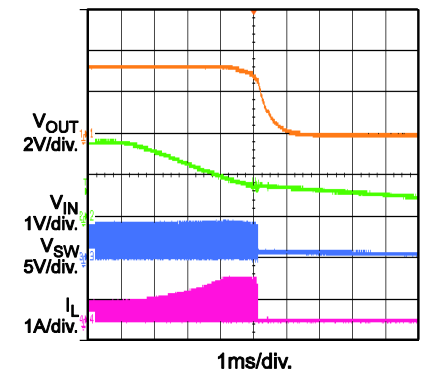

### EN Startup

$I_{OUT} = 0A$

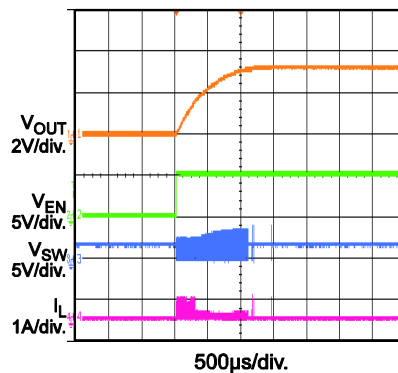

### EN Startup

$I_{OUT} = 0.2A$

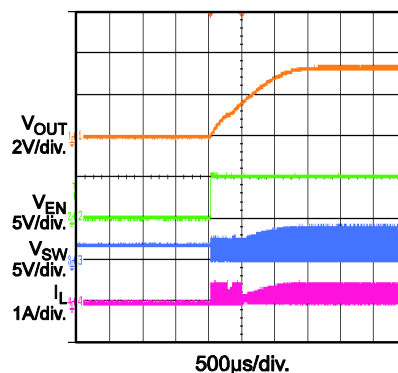

### EN Shutdown

$I_{OUT} = 0A$

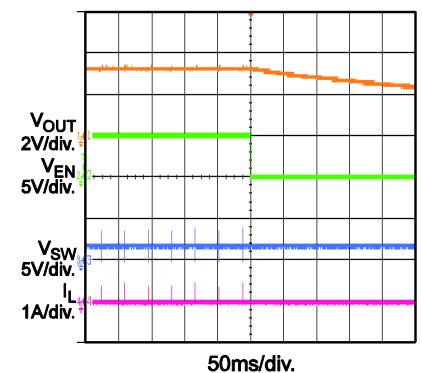

## EVB TEST RESULTS *(continued)*

$V_{IN} = 1.8\text{ V}$ ,  $V_{OUT} = 3.3\text{ V}$ ,  $L = 3.3\mu\text{H}$ ,  $T_A = 25^\circ\text{C}$ , unless otherwise noted.

### EN Shutdown

$I_{OUT} = 0.2\text{ A}$

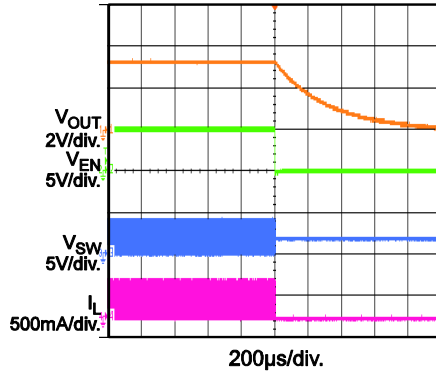

### SCP Enter

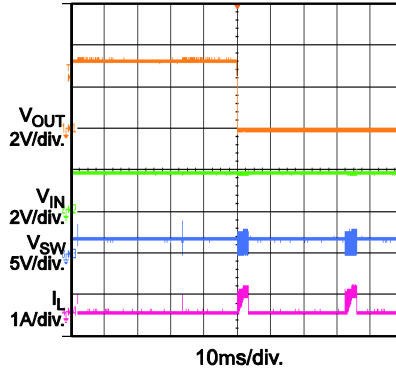

### SCP Recover

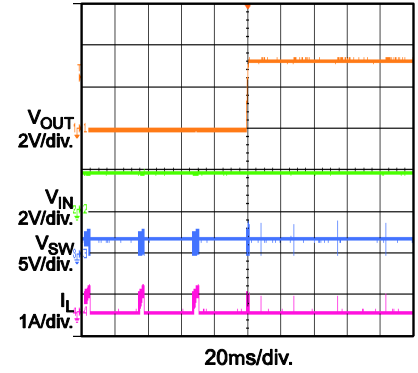

### Line Transient

$V_{IN} = 1.8\text{ V to } 3.6\text{ V}$ ,  $I_{OUT} = 0.1\text{ A}$

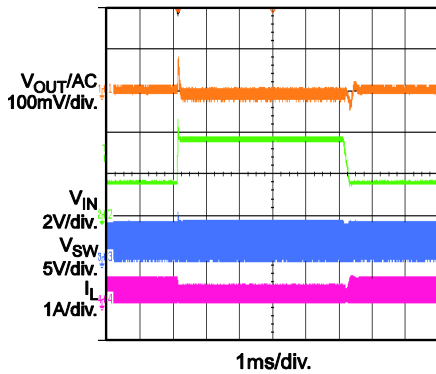

### Load Transient

$I_{OUT} = 0.1\text{ A to } 0.2\text{ A}$

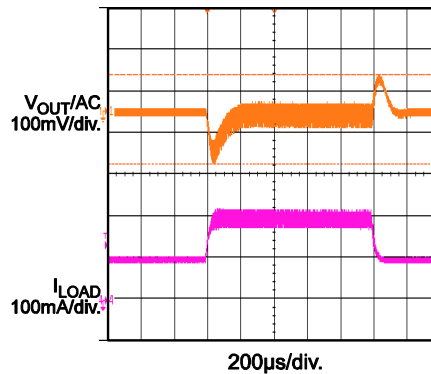

# PRINTED CIRCUIT BOARD LAYOUT

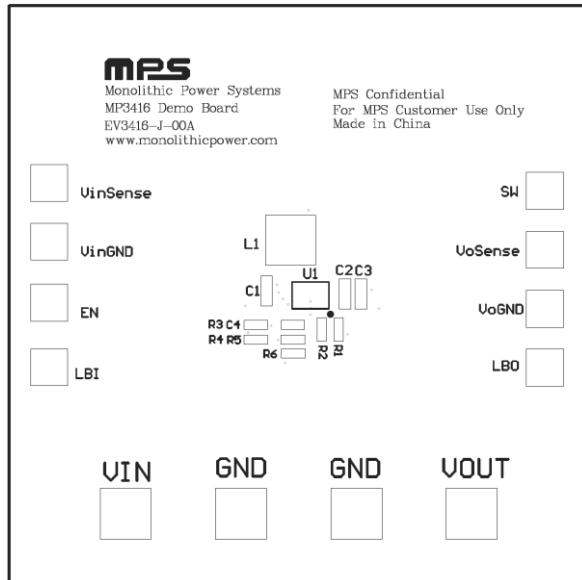

Figure 1—Top Silk Layer

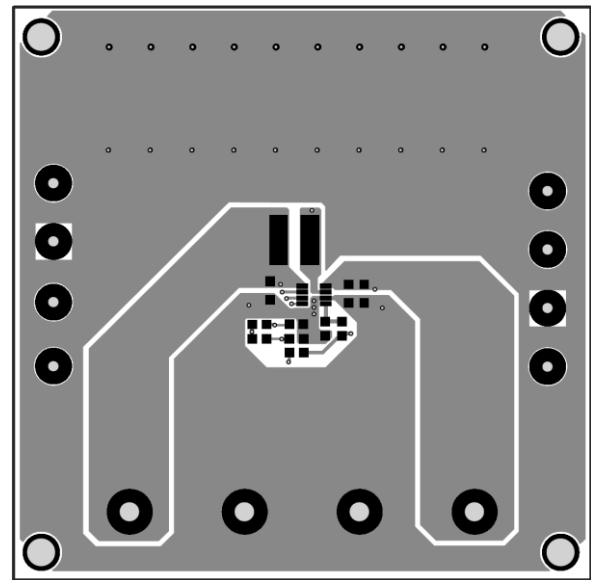

Figure 2—Top Layer

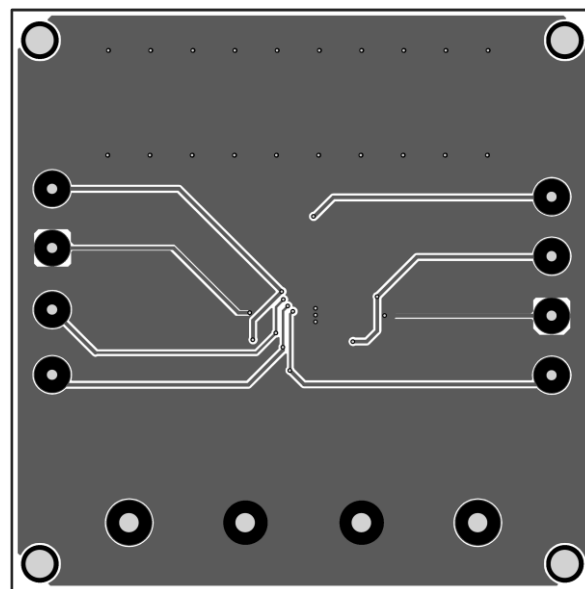

Figure 3—Bottom Layer

## Quick Start Guide

The output voltage of this board is set to 3.3V. The board layout accommodates most commonly used components.

1. Preset Power Supply to  $1.25V \leq V_{IN} \leq 5.5V$ .
2. Turn Power Supply off.
3. Connect Power Supply terminals to:
  - a. Positive (+): VIN
  - b. Negative (-): GND
4. Connect Load to:
  - a. Positive (+): VOUT
  - b. Negative (-): GND
5. Turn Power Supply on after making connections.
6. The MP3416 is enabled on the evaluation board once VIN is applied.
7. The output voltage VOUT can be changed by varying R2. Calculate the new value using the formula:

$$V_{OUT} = V_{FB} \times \left(1 + \frac{R1}{R2}\right)$$

Where  $V_{FB} = 0.504V$  and  $R1=1M\Omega$ .

8. To use the enable function, apply a digital input to the EN pin. Drive EN higher than 0.7V to turn on EV3416-J-00A or less than 0.2V to turn it off.

**NOTICE:** The information in this document is subject to change without notice. Please contact MPS for current specifications. Users should warrant and guarantee that third party Intellectual Property rights are not infringed upon when integrating MPS products into any application. MPS will not assume any legal responsibility for any said applications.