



The Future of Analog IC Technology®

EV3398T-F-00A

4 strings, 80V Return Voltage WLED Driver Evaluation Board

DESCRIPTION

The MP3398T is a step-up controller with 4 current channels, which is designed to drive WLED arrays for large-size LCD-panel backlighting applications. It is able to expand the number of LED channels with two or more ICs in parallel sharing a single power source.

The MP3398T uses peak-current mode with a fixed switching frequency. The frequency is programmable through an external setting resistor. The MP3398T drives an external MOSFET to boost up the output voltage from a 4.5V to 33V input supply. It regulates the current in each LED string to the value set by an external current-setting resistor.

The MP3398T applies 4 internal current sources for current balance. The current matching can achieve 2% regulation accuracy between strings. Its low regulation voltage on LED current sources reduces power loss.

The MP3398T supports direct PWM dimming. In addition, rich protection modes are integrated including OCP, OTP, UVP, OVP, LED short/open protection, inductor/diode short protection.

The MP3398T is available in a TSSOP-16EP package.

ELECTRICAL SPECIFICATIONS

Parameter	Symbol	Value	Units
Input Voltage	V_{IN}	13 – 33	V
LEDs #		4 LED strings 20 LEDs/string	
LED Current	I_{LED}	120/string	mA

FEATURES

- 4-String, Max 400mA/String WLED Driver
- 4.5V to 33V Input Voltage Range
- 80V Abs. Rating for Each String
- 2% Current Matching Accuracy Between Each String
- PWM Dimming
- Cascading Capability with a Single Power Source
- LED Open and Short LED Protection
- Programmable Recoverable Over Voltage Protection
- 0.2V Latch-off OCP Protection Threshold.
- Recoverable thermal Shutdown Protection
- TSSOP-16EP Package

APPLICATIONS

- Desktop LCD Flat Panel Displays
- All in one
- 2D/3D LCD TVs

All MPS parts are lead-free and adhere to the RoHS directive. For MPS green status, please visit MPS website under Products, Quality Assurance page.

"MPS" and "The Future of Analog IC Technology" are registered trademarks of Monolithic Power Systems, Inc.

EV3398T-F-00A EVALUATION BOARD

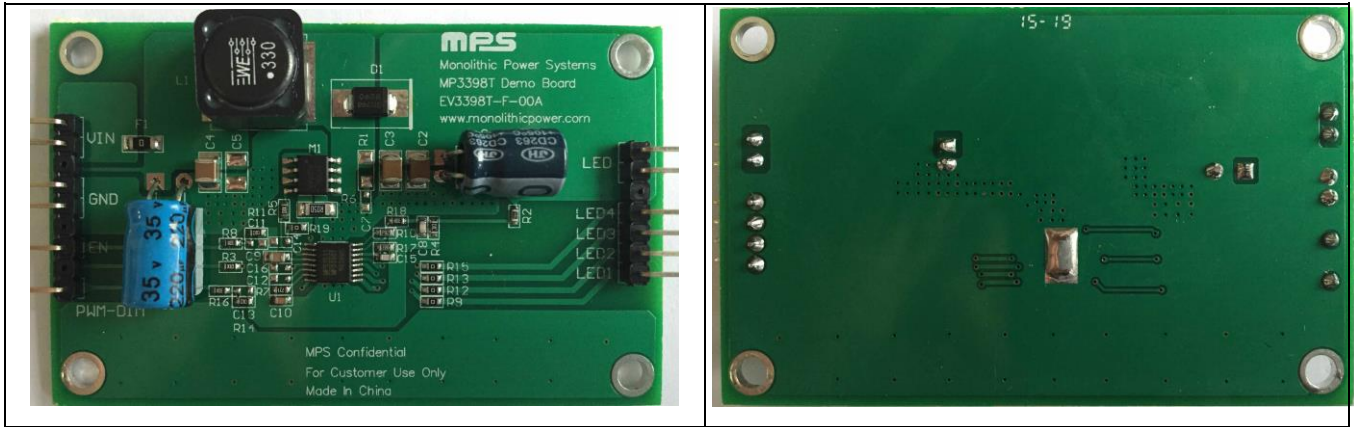

(L x W x H) 7.75cm x 4.88cm x 1.1cm

Board Number	MPS IC Number
EV3398T-F-00A	MP3398TGF

EVALUATION BOARD SCHEMATIC

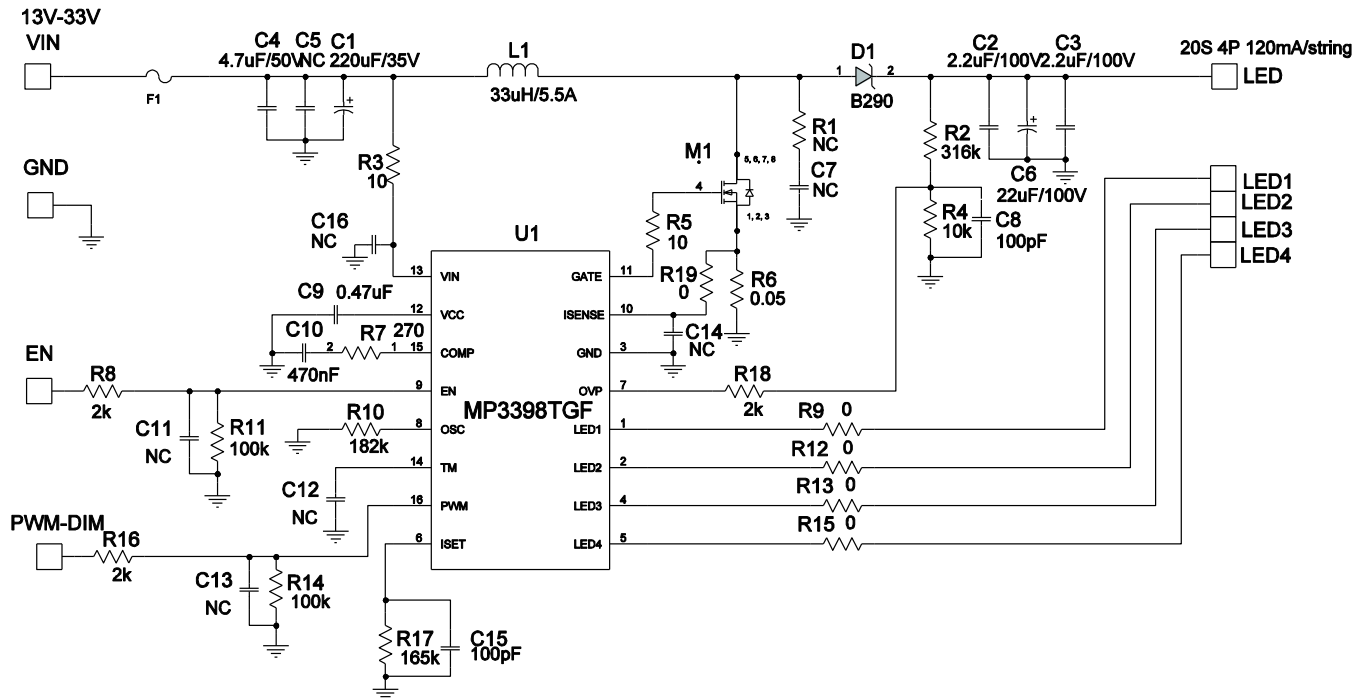

EV3398T-F-00A BILL OF MATERIALS

Qty	Ref	Value	Description	Package	Manufacturer	Part Number
1	C1	220 μ F	Electrolytic Capacitor, 35V			
2	C2,C3	2.2 μ F	Ceramic Capacitor, 100V, X7R	1210	Murata	GRM32ER72A225KA35L
1	C4	4.7 μ F	Ceramic Capacitor, 50V, X7R	1210	Murata	GRM32ER71H475KA88L
1	C5	NC		1210		
1	C6	22 μ F	Electrolytic Capacitor, 100V			
6	C7,C11, C12, C13,C14, C16	NC		0603		
2	C8,C15	100pF	Ceramic Capacitor,50V, COG	0603	Murata	GRM1885C1H101JA01D
1	C9	470nF	Ceramic Capacitor, 16V, X7R	0805	Murata	GRM219R71C474KA01D
2	C10	470nF	Ceramic Capacitor, 16V, X7R	0603	Murata	GRM18R7C474KA88D
1	D1		Diode Schottky, 90V, 2A	SMB	Diodes Inc	B290
1	F1	0 Ω	Fuse, 2A, 63V	1206	Cooper	3216FF2-R
1	L1	33 μ H	Inductor,5.5A,45mohm	SMD	Würth	7447709330
1	M1		N- channel MOSFET	SO8	Analog Power	AM4490N
1	R1	NC		0603		
1	R2	316k Ω	Resistor, 1%	0603	Yageo	RC0603FR-07316KL
2	R3,R5	10 Ω	Resistor, 1%	0603	Yageo	RC0603FR-0710RL
1	R4	10k Ω	Resistor, 1%	0603	Yageo	RC0603FR-0710KL
5	R9,R12, R13, R15,R19	0 Ω	Resistor, 1%	0603	Yageo	RC0603JR-070RL
1	R7	270 Ω	Resistor, 1%	0603	Yageo	RC0603FR-07270RL
1	R6	0.05 Ω	Current Resistor, 1%	1206	Yageo	RC1206FR-070R05L
3	R8,R16, R18	2k Ω	Resistor, 1%	0603	Yageo	RC0603FR-072KL
1	R10	182k Ω	Resistor, 1%	0603	Yageo	RC0603FR-07182KL
2	R11,R14	100k Ω	Resistor, 1%	0603	Yageo	RC0603FR-07100KL
1	R17	165k Ω	Resistor, 1%	0603	Yageo	RC0603FR-07165KL
1	U1		LED Driver IC	TSSOP-16EP	MPS	MP3398TGF

EVB TEST RESULTS

Performance waveforms are tested on the evaluation board.

$V_{IN} = 19V$, 4 strings, 20 LEDs/string, $I_{LED} = 120mA/$ String, $T_A = 25^{\circ}C$, unless otherwise noted.

Steady State

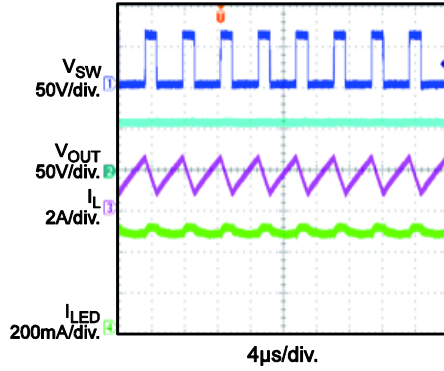

Power On

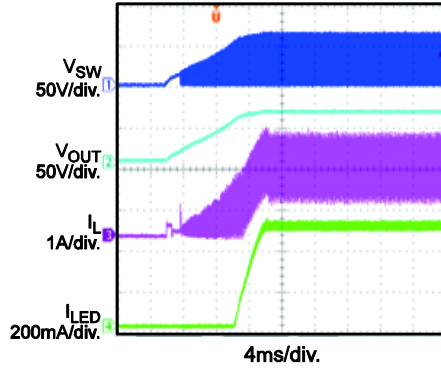

EN On

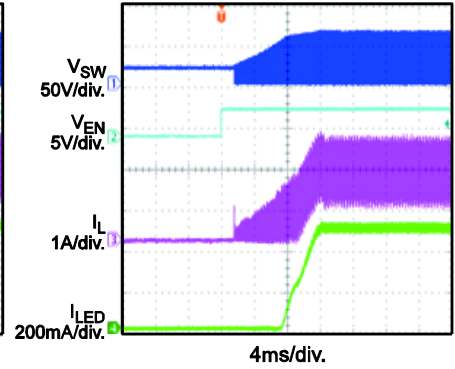

PWM Dimming

$f_{sw} = 200Hz$, $D_{PWM} = 50\%$

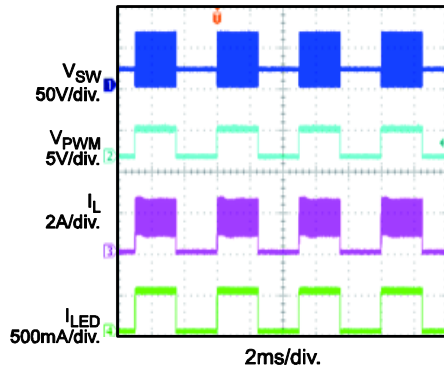

Open LED Protection

Open One LED String at Working

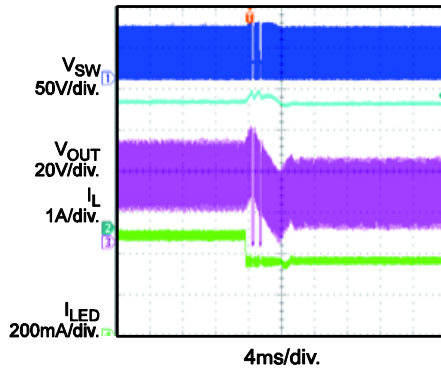

Short LED Protection

Short One LED String at Working

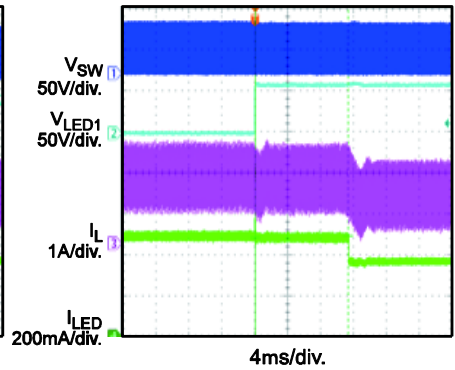

Short-Inductor Protection

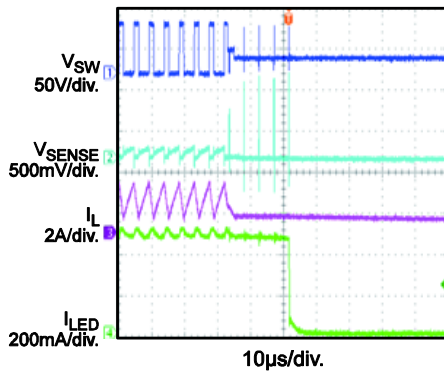

Short-Diode Protection

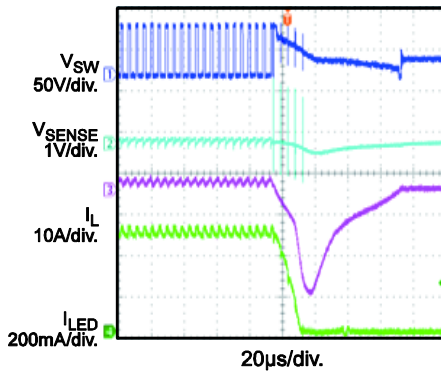

PRINTED CIRCUIT BOARD LAYOUT

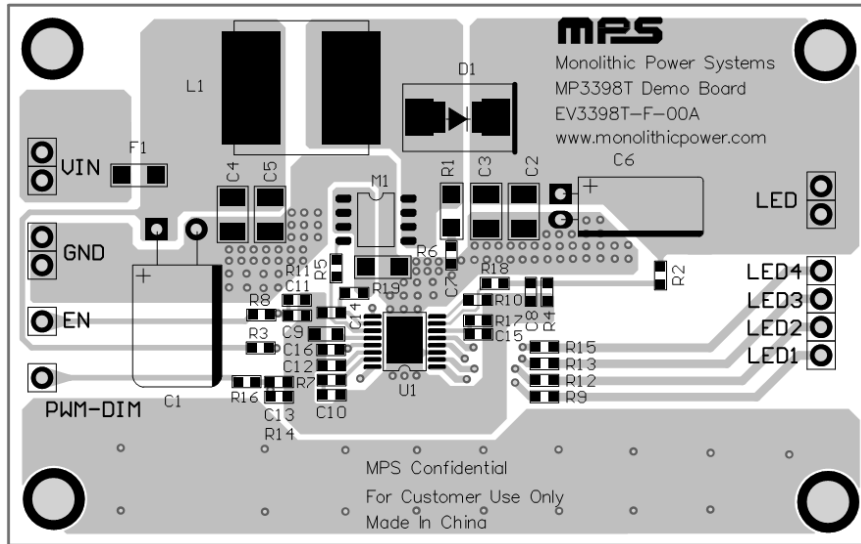

Figure 1—Top Layer

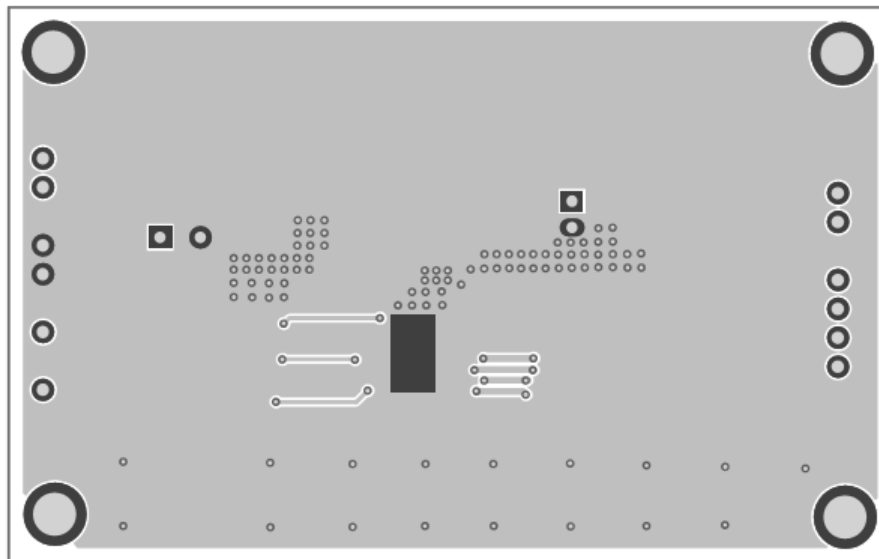

Figure 2—Bottom Layer

QUICK START GUIDE

1. Connect the positive and negative terminals of the load panel (20 white LEDs in series, 4 strings) to the LED+ and LED1~4 pins on the EV board, respectively.
2. Connect the positive and negative terminals of the power supply (13V ~ 33V) to the VIN and GND pins on the EV board, respectively.
3. Drive EN pin high (5V) to enable the MP3398T.
4. For PWM dimming, apply a PWM rectangular waveform with a minimum voltage less than 0.4V and a maximum greater than 1.5V on PWM-DIM pin. The frequency of the PWM signal is recommended between 200Hz to 2kHz.

NOTICE: The information in this document is subject to change without notice. Users should warrant and guarantee that third party Intellectual Property rights are not infringed upon when integrating MPS products into any application. MPS will not assume any legal responsibility for any said applications.