



The Future of Analog IC Technology®

# EV3336-C-00A

## Dual-Channel Flash LED Driver With 2A/Ch and I<sup>2</sup>C Interface Evaluation Board

### DESCRIPTION

The MP3336 is a dual-channel and high-power flash LED driver with very compact package. It can drive up to 2A in flash mode for each LED. It is usually applied for camera phones to improve image and video quality in low light environment. The device operates in 1/2/3/4MHz synchronous, current-mode PWM boost converter to regulate the LED current with two high current source. The MP3336 provides an optimized solution for smaller PCB space and higher efficiency.

The MP3336 features standard I<sup>2</sup>C interface, dual LED channels, rich protection modes and high power density and performances. It supports flash/assist/torch/indicator/5V DC modes.

The cathodes of the dual flash LED are referenced to GND, which is better for layout to improve thermal performance. It is available in WLCSP20-1.6X2.0mm package.

### ELECTRICAL SPECIFICATIONS

Parameter	Symbol	Value	Units
Input Voltage	V <sub>IN</sub>	2.7-5.5	V
Output Voltage	V <sub>out</sub>	<5.5	V
LEDs #		2	
LED Current/Ch	I <sub>LED</sub>	Max.2	A

### FEATURES

- 2.7V~5.5V Input Voltage
- 1/2/3/4MHz Selectable Max Switching Frequency
- Switching Frequency Fold-Back Function
- 400kHz I<sup>2</sup>C Compatible Interface
- Standby/Flash/Assist/Torch/Indicator/5V DC Modes

#### **Flash Mode:**

Up to 2A/Ch Programmable Current with +/-7% Accuracy for Each LED, 7.84mA/Step

#### **Assist/Torch Mode:**

Up to 319mA/Ch Programmable Current with +/-7% Accuracy for Each LED, 1.25mA/Step

#### **Indicator Mode:**

Work In 31.5kHz PWM Dimming Mode With 2/16, 3/16, 4/16, 5/16 Duty Cycle

Used for Blinking and 128/256/512ms Selectable Blinking Time

#### **5V DC Mode:**

Output Constant 5V DC Voltage

- 1A to 4.2A Programmable Input DC Current Limit Protection
- External Torch/Strobe/TX Pin
- LED Forward Voltage Balance to Improve Efficiency
- VIN to VOUT Disconnection Function
- Low Battery Voltage Protection
- LED Short/Open Protection
- VOUT-GND Short Protection
- Over Voltage Protection
- Over Temperature Protection
- Input Under Voltage Lockout Protection
- Available In WLCSP20-1.6X2.0mm

### APPLICATIONS

- Smart Phone Flash LED Application
- Cameras for Tablet
- Digital Still Camera

All MPS parts are lead-free, halogen free, and adhere to the RoHS directive. For MPS green status, please visit MPS website under Quality Assurance.

"MPS" and "The Future of Analog IC Technology" are Registered Trademarks of Monolithic Power Systems, Inc.

## EV3336-C-00A EVALUATION BOARD

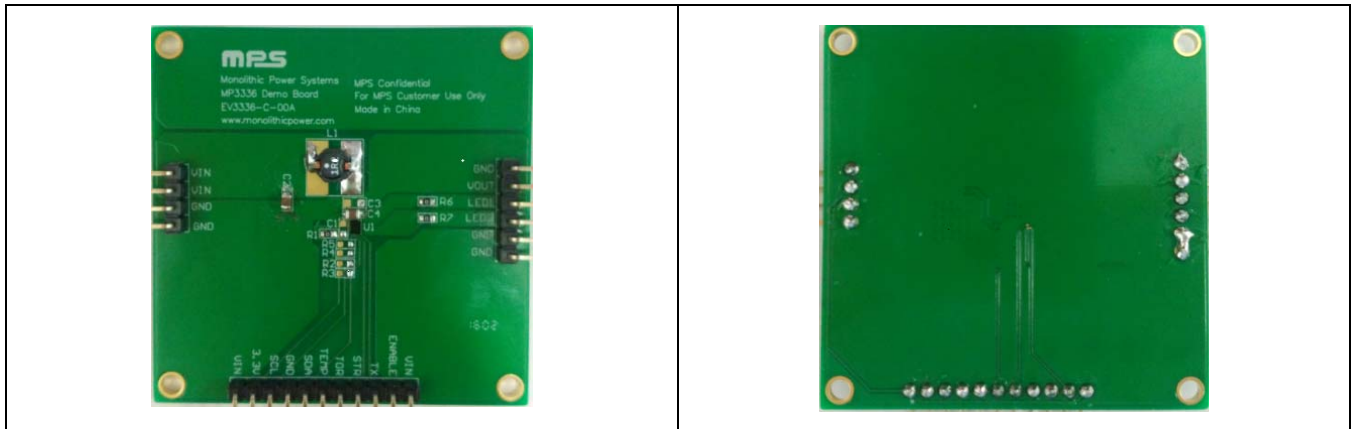

(L x W x H) 5.5cm x 5.5cm x 1cm

Board Number	MPS IC Number
EV3336-C-00A	MP3336GC

## EVALUATION BOARD SCHEMATIC

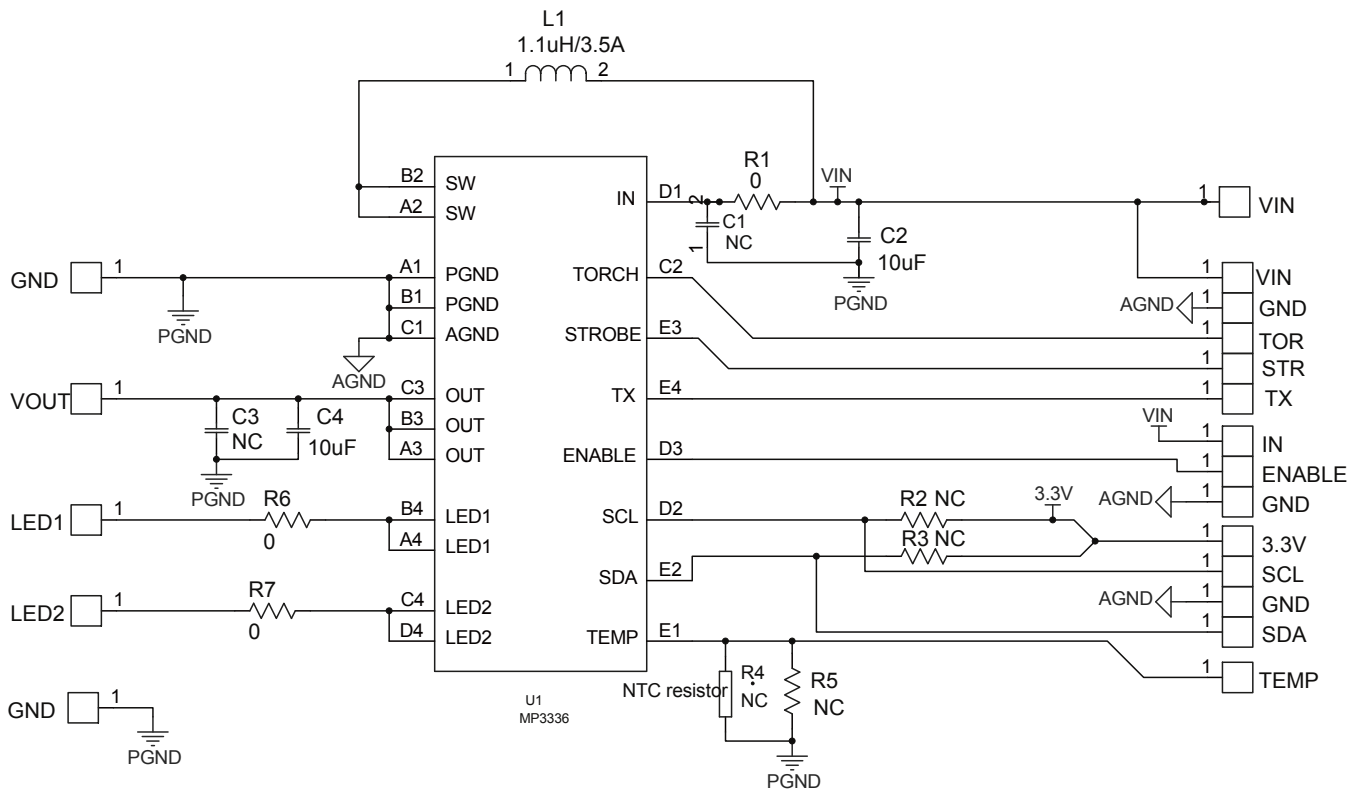

**EV3336-C-00A BILL OF MATERIALS**

Item	Ref	Value	Description	Footprint	Manufacturer	Manufacturer P/N
1	C1	NC		0603		
1	C2,C4	10 $\mu$ F	ceramic capacitor,10V,X5R	0805	muRata	GRM21BR61A106KE19L
2	C3	NC		0805		
1	R1,R6,R7	0	res,1%	0603	Yageo	RC0603FR-070RL
1	R2,R3,R4,R5	NC		0603		
1	L1	1.1 $\mu$ H	1.1 $\mu$ A, 20m,3.46A		TDK	D53LC-#A915AY-1R1M
1	U1		MP3336	CSP20 1.6*2mm	MPS	MP3336

## EVB TEST RESULTS

Performance waveforms are tested on the evaluation board.

**V<sub>IN</sub> = 3.6V, L = 1.1μH, I<sub>1/2\_TOR</sub> = 300mA, I<sub>1/2\_FL</sub> = 400mA, I<sub>1/2\_TX</sub> = 400mA, FL\_TIM = 200ms, 2 Channel. Unless otherwise noted.**

### Torch/Assist Mode

LED\_EN Bit Enable

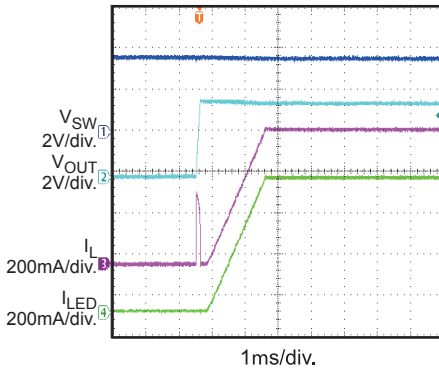

### Torch/Assist Mode

LED\_EN Bit Disable

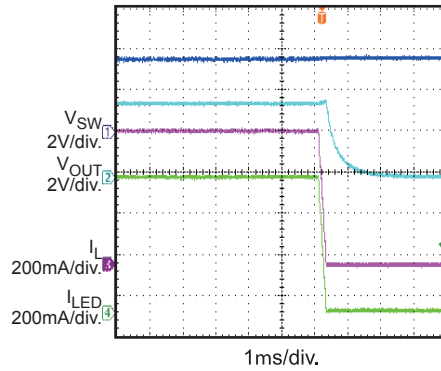

### Indicator Mode

I<sub>LED</sub> Duty = 5/16,  
I<sub>LED\_AMPLITUDE/Ch</sub> = 100mA

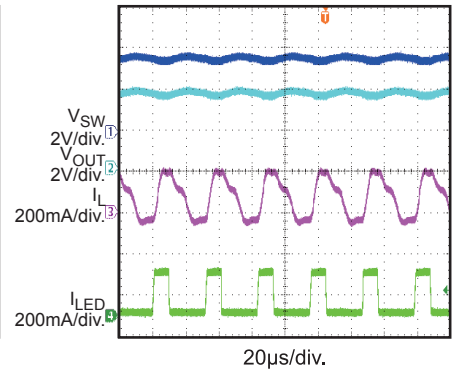

### Blinking Mode

Blinking Time = 128ms

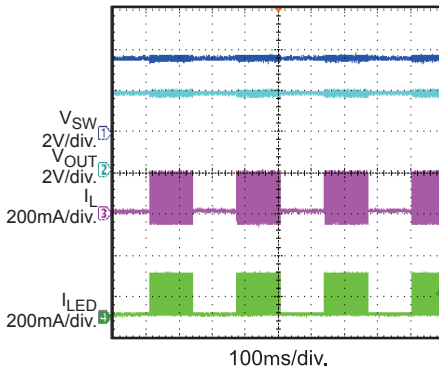

### Flash Mode

with Level Trigger Way

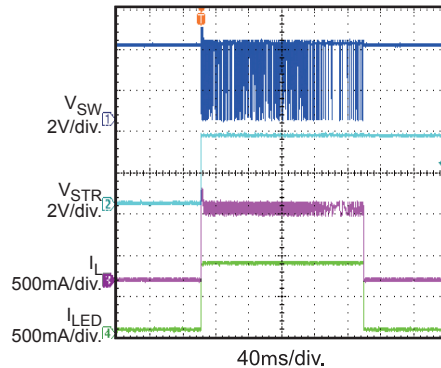

### Flash Mode

with Edge Trigger Way

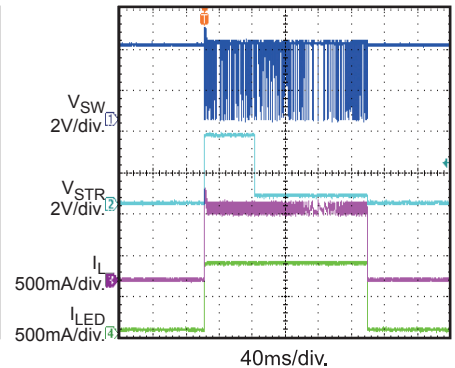

### Flash Mode

FL\_TIM = 1600ms, I<sub>1\_FL</sub> = 2A,  
LED2\_EN = 0

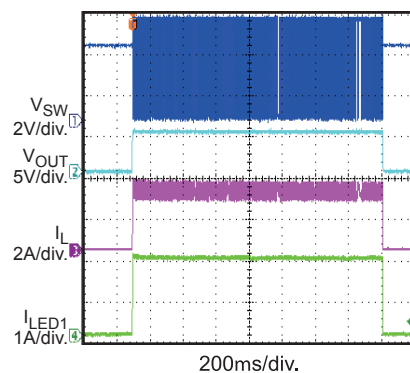

### Flash Mode

TX pin with 2Hz, 50% pulse,  
I<sub>1/2\_FL</sub> = 1A

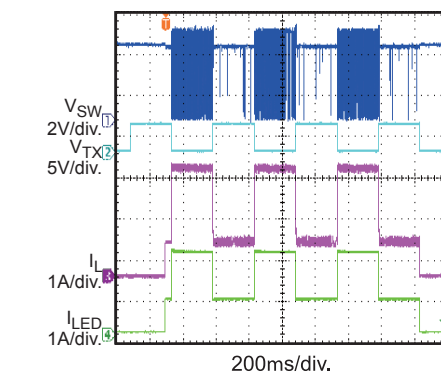

### Torch/Assist Mode

to Flash Mode  
I<sub>1/2\_TOR</sub> = 120mA

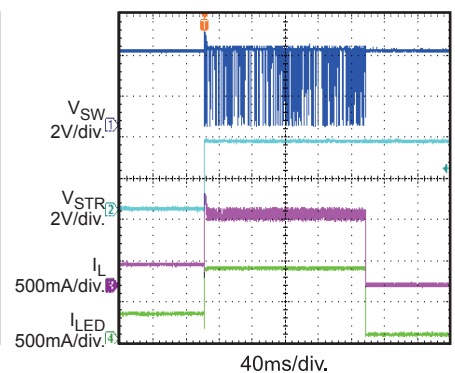

## EVB TEST RESULTS

Performance waveforms are tested on the evaluation board.

V<sub>IN</sub> = 3.6V, L = 1.1μH, I<sub>1/2\_TOR</sub> = 300mA, I<sub>1/2\_FL</sub> = 400mA, I<sub>1/2\_TX</sub> = 400mA, FL\_TIM = 200ms, 2 Channel. Unless otherwise noted.

### Load Balance

Set BAL\_ON Bit from 0 to 1

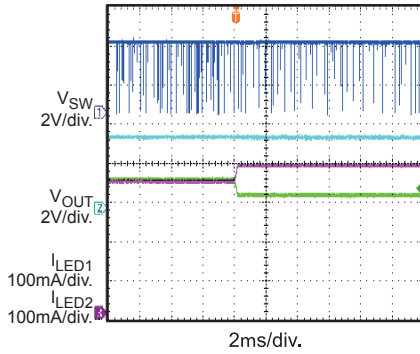

### 5V\_DC Mode

V<sub>OUT</sub> to GND with 75Ω Resistor

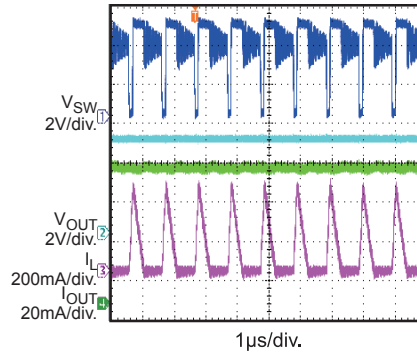

### Short LED to GND Protection

Short One Channel when Working

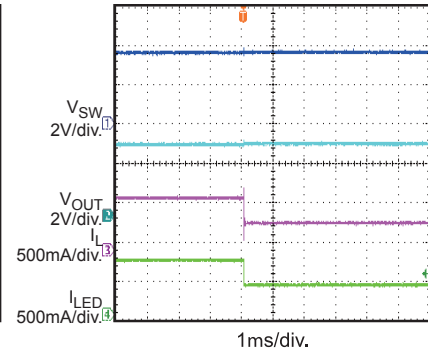

### Open LED Protection

Open one Channel when Working

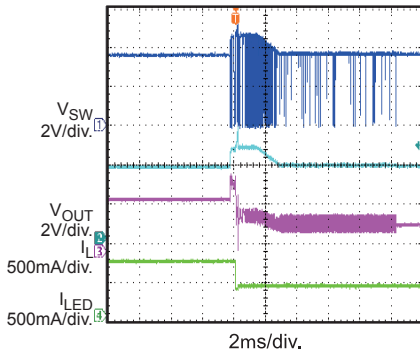

### V<sub>OUT</sub> to GND Short Protection

when Working

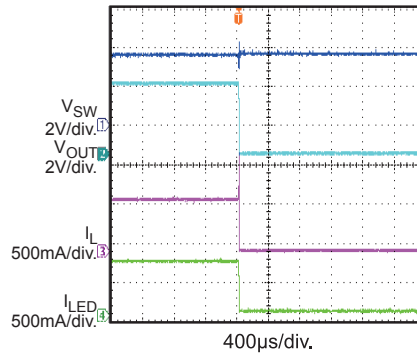

### Thermal Protection

Flash Mode, Set LED\_OTAD=1, I<sub>1/2\_FL</sub> = 600mA, FL\_TIM = 1600ms

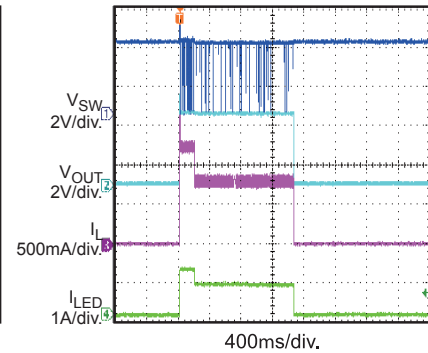

### Thermal Protection

Assist Mode, Set LED\_OTAD=0

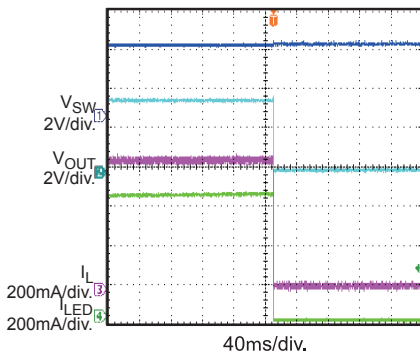

### NTC Detection

Set NTC\_WD = 0.88V, Set LED\_T\_SD = 1

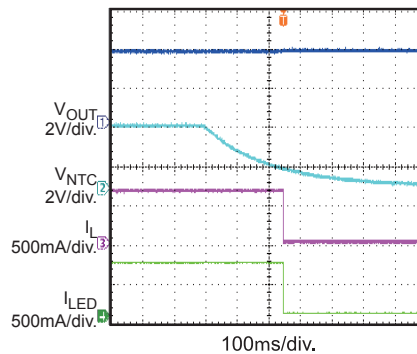

## PRINTED CIRCUIT BOARD LAYOUT

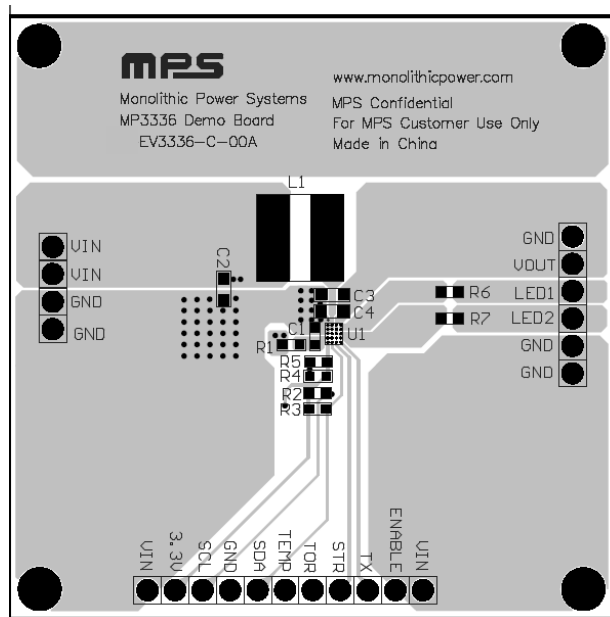

Figure 1—Top Layer

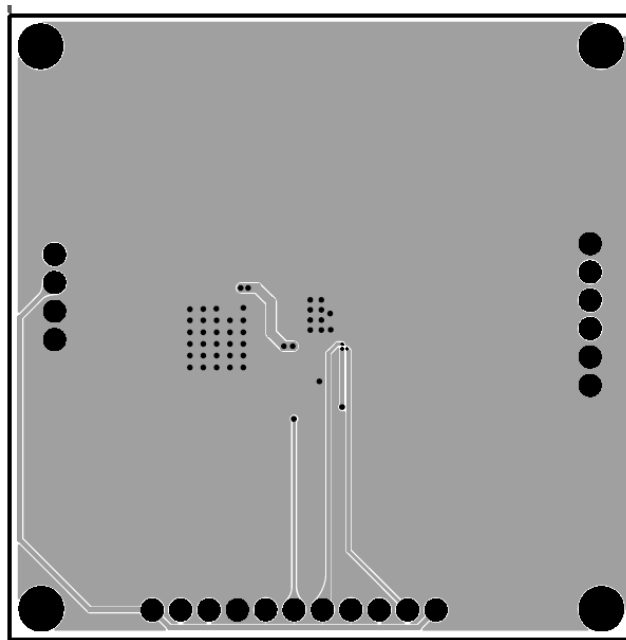

Figure 2—Bottom Layer

## QUICK START GUIDE

1. Connect the positive and negative terminals of the power supply (2.7V ~ 5.5V) to the VIN and GND pins on the EV board, respectively.
2. Supply the EN terminal with logical signal.
3. Connect the positive and negative terminals of the LED to the LED1/2 pin and GND on the EV board, respectively.
4. Please connect SCL, SDA and GND of EV board to SCL, SDA and GND of a programmable kit with I<sup>2</sup>C interface, respectively.
5. When work in Torch mode, please pull torch terminal to high. When work in flash mode with hardware trigger mode, please give a level or pulse signal to STR pin.

**NOTICE:** The information in this document is subject to change without notice. Please contact MPS for current specifications. Users should warrant and guarantee that third party Intellectual Property rights are not infringed upon when integrating MPS products into any application. MPS will not assume any legal responsibility for any said applications.