



EV3309-QG-00A

40mA, Synchronous Boost White LED Driver with I²C Interface Evaluation Board

DESCRIPTION

The EV3309-QG-00A is designed for the MP3309, a WLED driver. The device has a 2.7V to 5.5V input voltage range and uses peak current mode control to regulate the LED current sensed through an external, low-side resistor. Synchronous rectification and the 200mV feedback voltage reduce power loss and PCB size. To save driver losses, select non-synchronous mode by using an internal register to disable the rectifier MOSFET.

The MP3309 features a configurable switching frequency to optimize efficiency. It supports both analog and PWM dimming.

In addition, the MP3309 has LED open protection, cycle-by-cycle current limit protection, under-voltage protection (UVP), and thermal shutdown protection. The I²C interface can set the protection indication bits and the over-voltage protection (OVP) threshold.

The MP3309 is available in a QFN-10 (1.4mmx1.8mm) package

ELECTRICAL SPECIFICATIONS

Parameter	Symbol	Value	Units
Input voltage	V _{IN}	2.7 to 5.5	V
Output voltage	V _{LED}	<35	V
LED current	I _{LED}	40	mA

FEATURES

- 2.7V to 5.5V Input Voltage Range
- Analog and PWM Dimming
- Selectable Synchronous or Non-Synchronous Mode
- 400kHz I²C-Compatible Interface
- Digitally Set LED Current
- Configurable Switching Frequency
- Configurable Over-Voltage Protection (OVP) Threshold
- Low 200mV Feedback Voltage with ±1% Accuracy
- Software or Hardware Enable Function
- Internal Soft Start
- Under-Voltage Lockout (UVLO), Thermal Shutdown, and Over-Current Protection (OCP)
- The MP3309 Supports Default Analog Dimming (PWMH) via the External PWM Signal Input
- The MP3309C Provides a Default I²C Interface
- Available in a QFN-10 (1.4mmx1.8mm) Package

APPLICATIONS

- Feature Phones and Smartphones
- Tablets
- <10inch Video Displays

All MPS parts are lead-free, halogen-free, and adhere to the RoHS directive. For MPS green status, please visit the MPS website under Quality Assurance. "MPS", the MPS logo, and "Simple, Easy Solutions" are registered trademarks of Monolithic Power Systems, Inc. or its subsidiaries.

EV3309-QG-00A EVALUATION BOARD

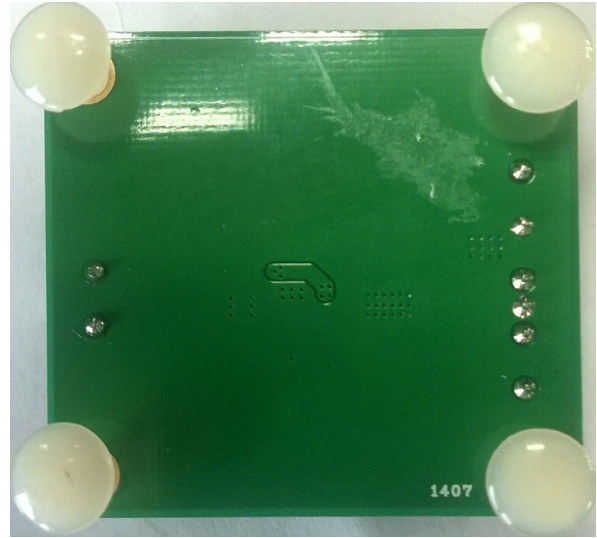
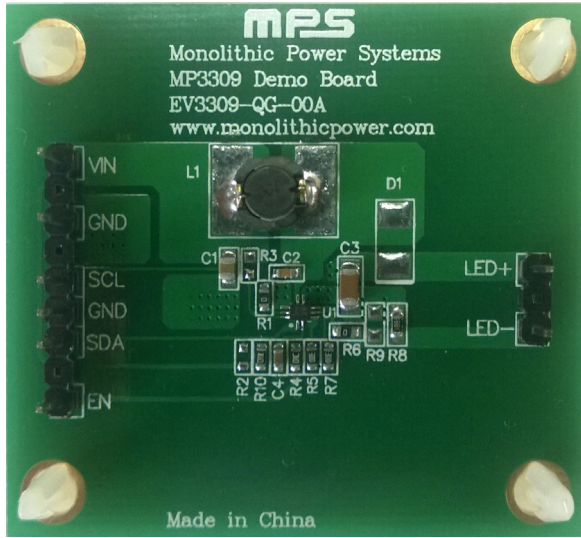

LxWxH (5cmx4.6cmx1.0cm)

Board Number	MPS IC Number
EV3309-QG-00A	MP3309GQG

QUICK START GUIDE

1. Place a voltage source (2.7 to 5.5V) between the VIN terminal and GND.
2. Connect the LED strings between LED+ and LED-.
3. Set the dimming mode.

Analog Dimming

1. Pull the EN/PWML pin to logic high. To select analog dimming for different ICs, follow the instructions below:
 - a. MP3309: the default analog dimming is set by an external PWM input. For analog dimming, connect the SCL and SDA pins together to act as PWMH, then add a >20kHz PWM signal to PWMH.
 - b. MP3309C: the MP3309C can work with the I²C interface. Control the dimming via register 00h, bits[D0:D4]. Set the EN bit to 1 before dimming.

PWM Dimming

1. Connect the SCL and SDA pins together, then pull these pins to logic high.
2. Apply a 200Hz to 2kHz PWM signal to the EN/PWML pin.
3. To select the output current using a resistor on the FB pin, see the related IC datasheet for more details.

EVALUATION BOARD SCHEMATIC

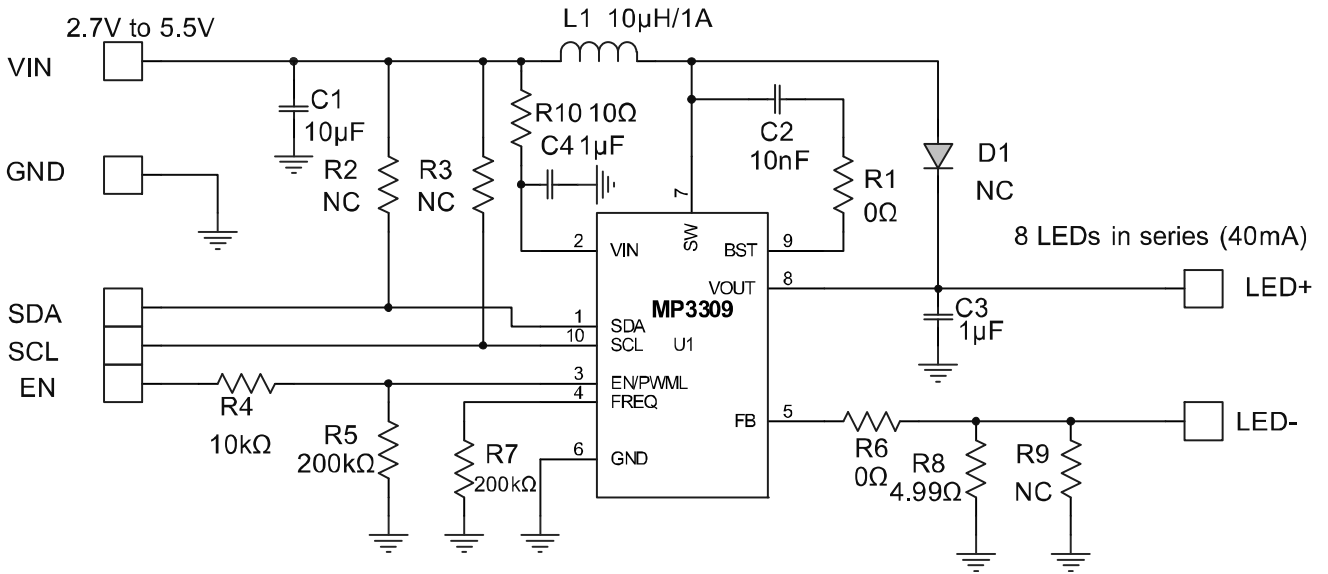

Figure 1: Evaluation Board Schematic

EV3309-RT-00A BILL OF MATERIALS

Qty	Ref	Value	Description	Package	Manufacturer	Manufacturer P/N
1	C1	10 μ F	Ceramic capacitor, 6.3V, X7R	0805	Murata	GCM21BR70J106KE2
1	C2	10nF	Ceramic capacitor, 50V, X7R	0603	Murata	GRM188R71H103KA01D
1	C3	1 μ F	Ceramic capacitor, 50V, X7R	1206	Murata	GRM31MR71H105KA88L
1	C4	1 μ F	Ceramic capacitor, 6.3V, X5R	0603	Murata	GRM188R60T105KA01D
1	D1	NC				
1	L1	10 μ H	Inductor, 1.14A, DCR = 59m Ω	SMD	Toko	D63LCB-A921CY-100M=P3
2	R1, R6	0 Ω	Resistor, 0 Ω , 5%	0603	Yageo	RC0603JR-070RL
1	R10	10 Ω	Resistor, 10 Ω , 1%	0603	Yageo	RC0603FR-0710RL
3	R2, R3, R9	NC				
2	R5, R7	200k Ω	Resistor, 200k Ω , 1%	0603	Yageo	RC0603FR-07200KL
1	R4	10k Ω	Resistor, 10k Ω , 1%	0603	Yageo	RC0603FR-0710KL
1	R8	4.99 Ω	Resistor, 4.99 Ω , 1%	0603	Yageo	RC0603FR-074R99L
1	U1	MP3309	White LED driver	QFN-10 (1.4mmx1.8mm)	MPS	MP3309GQG

EVB TEST RESULTS

Performance waveforms are tested on the evaluation board. $V_{IN} = 3.6V$, 8 LEDs in series, $I_{LED} = 40mA$, $L = 10\mu H$, $T_A = 25^\circ C$, unless otherwise noted.

Steady State

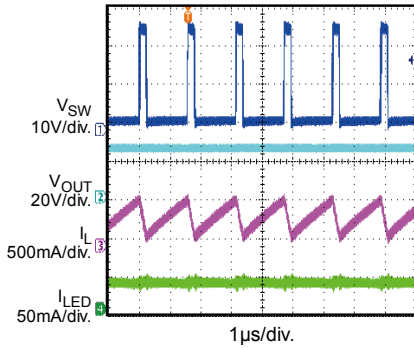

Start-Up through VIN

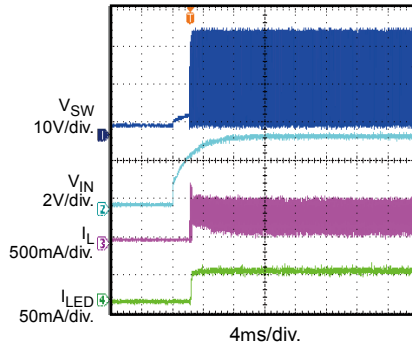

Start-Up through EN

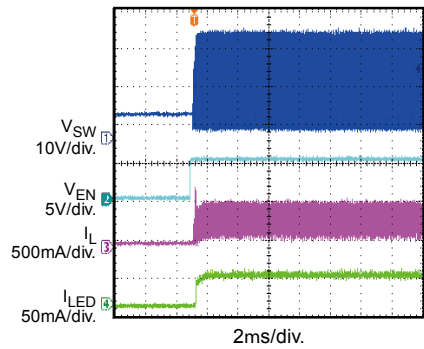

PWM Dimming

$f_{DIM} = 200Hz$, $D_{DIM} = 50\%$

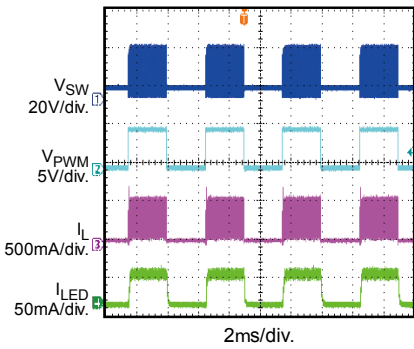

Analog Dimming

$f_{DIM} = 20kHz$, $D_{DIM} = 90\%$

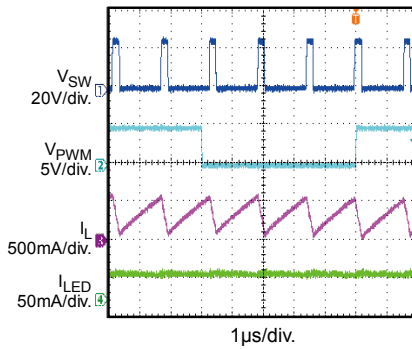

Open LED Protection

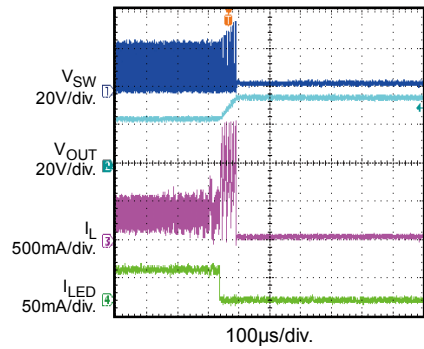

Set I_{LED} via the I²C

For the MP3309C

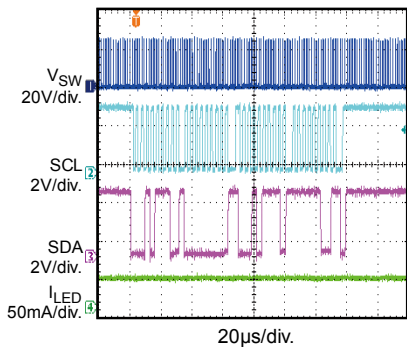

Set Enable Bit to 1

For the MP3309C

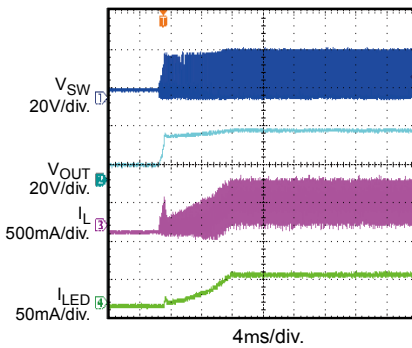

PCB LAYOUT

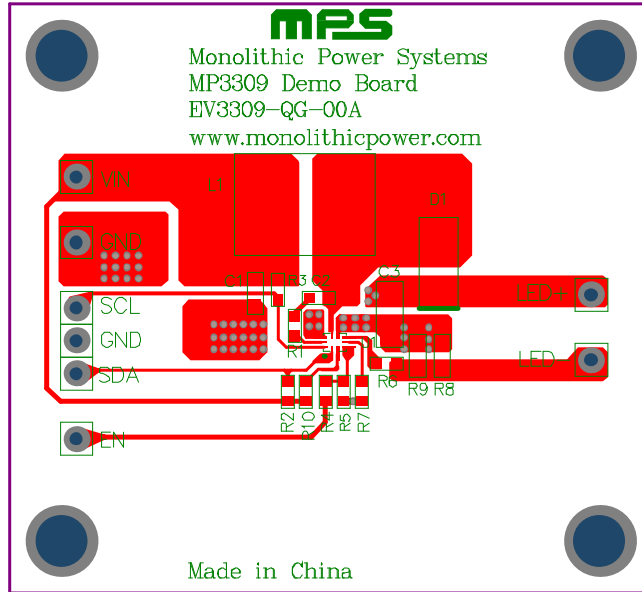

Figure 2: Top Layer

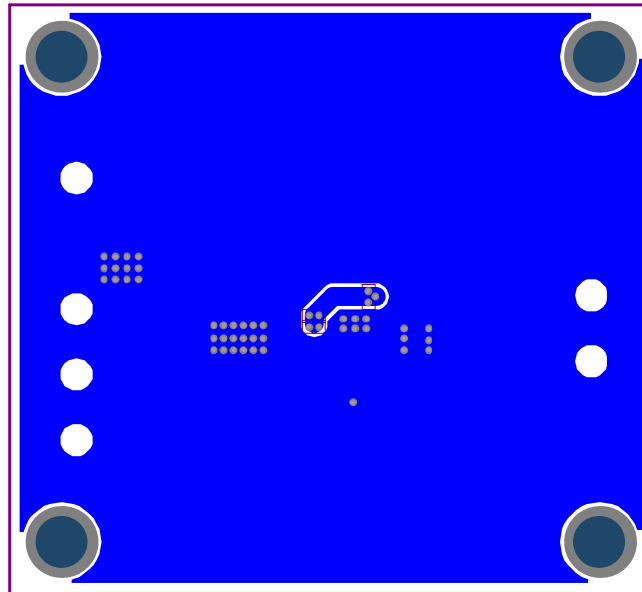

Figure 3: Bottom Layer



Revision History

Revision #	Revision Date	Description	Pages Updated
1.0	06/19/2014	Initial Release	-
1.1	03/13/2015	EVB waveforms added	P6
1.2	02/24/2021	Grammar review	All

Notice: The information in this document is subject to change without notice. Please contact MPS for current specifications. Users should warrant and guarantee that third-party Intellectual Property rights are not infringed upon when integrating MPS products into any application. MPS will not assume any legal responsibility for any said applications.