



The Future of Analog IC Technology™

EV3221-J-00A

2.7A, 1.2MHz, Step up Converter With Input Disconnection EV board

DESCRIPTION

The MP3221 is a 1.2MHz frequency, 6-pin TSOT23 current mode step up converter intended for small, low power applications. The device can step up three-cell alkaline, NiCd, and NiMH batteries, or a single-cell Li-on battery up to 6V. It is capable of delivering 1A output current at 5V with a supply voltage of 3V.

The MP3221 provides the internal soft start and compensation to minimize the external component count and help producing a compact solution. It integrates a FAULT driver for external PMOS to disconnect the output from input when the part shuts down or in output short circuit condition. This disconnect feature allows the output to be completely discharged, thus allowing the part to draw less than 1µA off current in shutdown mode.

The MP3221 is available in a small 6-pin TSOT-23 package.

Parameter	Symbol	Value	Units
Input Voltage	V_{IN}	2.5 - 4.8	V
Output Voltage	V_{OUT}	5	V
Output Current	I_{OUT}	1	A

FEATURES

- Integrated 88mΩ Power MOSFET
- 270µA Quiescent Current
- 2.5V to 6V Input Voltage
- 3V to 6V Output Voltage
- 1.2MHz Fixed Switching Frequency
- Internal 2.7A Switch Current Limit
- Integrated Input Disconnect Driver
- Internal Soft Start and Compensation
- True Output Disconnect from Input
- Under voltage lockout
- Short-Circuit Protection
- Over-Temperature Protection
- Available in a 6-Pin TSOT23-6 Package

APPLICATIONS

- Single-Cell Li-on Battery or Three-Cell Alkaline, NiCd, or NiMH Batteries Based Products
- Portable Media Players
- Wireless Peripherals
- Handheld Computers and Smart phones

All MPS parts are lead-free and adhere to the RoHS directive. For MPS green status, please visit MPS website under Products, Quality Assurance page.

"MPS" and "The Future of Analog IC Technology" are Registered Trademarks of Monolithic Power Systems, Inc.

EV3221-J-00A EVALUATION BOARD



(L x W x H) 2.5" x 2.5" x 0.4"
(6.35cm x 6.35cm x 1.0cm)

Board Number	MPS IC Number
EV3221-J-00A	MP3221GJ

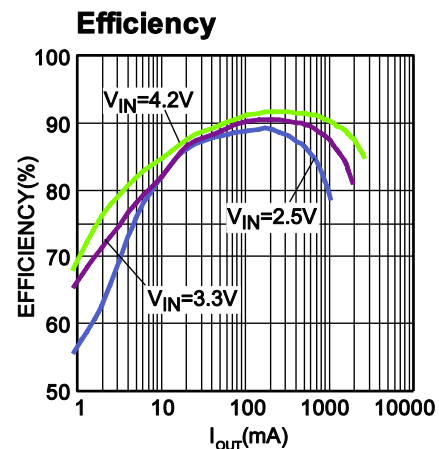

EVALUATION BOARD SCHEMATIC

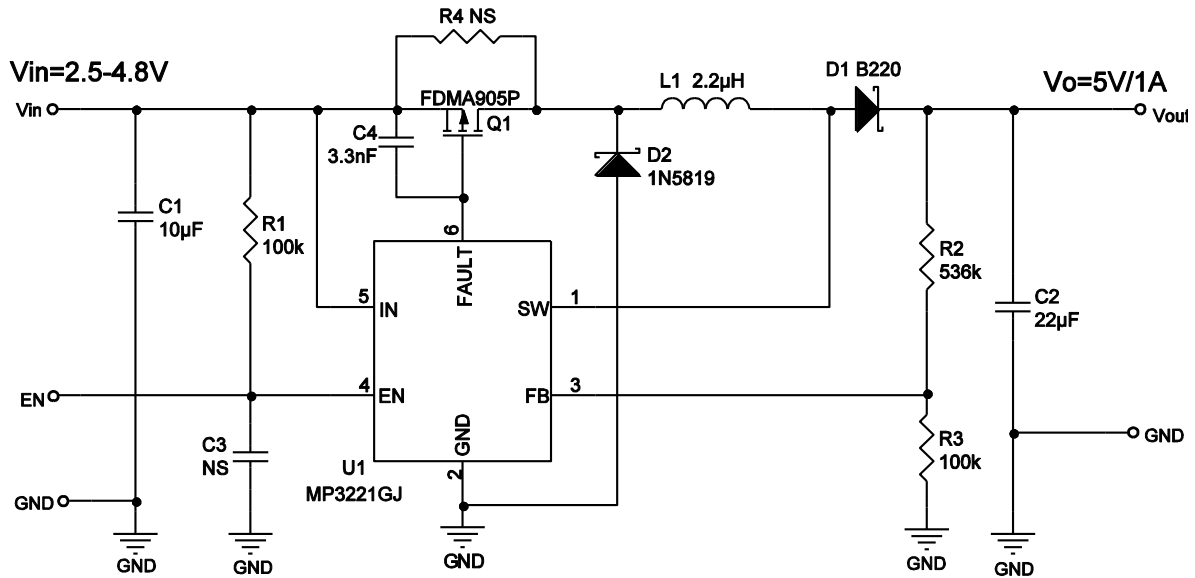

EV3221-J-00A BILL OF MATERIALS

Qty	Ref	Value	Description	Package	Manufacturer	Part Number
1	U1	MP3221GJ		MPS	TSOT23-6	MP3221GJ
1	Q1	FDMA905P	12V,10A,16mOhm P channel MOSFET	FairChild	MicroFET-2x2	FDMA905P
1	L1	2.2uH	10mOhm, 5.5A saturation current	TDK	SMD	RLF7030-2R2M5R4
1	R1	100K	5% film resistor	Yageo	0603	RC0603JR-07100KL
1	R2	536k	1% film resistor	Yageo	0603	RC0603FR-07536k
1	R3	100k	1% film resistor	Yageo	0603	RC0603FR-07100K
1	R4	NC				
1	C1	10uF	10V X5R Ceramic Capacitor	Murata	1210	GRM32ER61A106KA01L
1	C2	22uF	10V X5R Ceramic Capacitor	Murata	1210	GRM32ER61A226KE20L
1	C3	NS				
1	C4	3.3nF	50V X5R Ceramic Capacitor	Murata	0603	GRM188R71H332KA01D
1	D1	B220	Schottky diode, 20V, 2A	DIODES	SMA	B220
1	D2	1N5819	Schottky diode, 40V, 1A	DIODES	SOD-123	1N5819HW

TYPICAL PERFORMANCE CHARACTERISTICS

$V_{IN}=3.3V$, $V_{OUT}=5V$, $I_{OUT}=1A$, $T_A=25^{\circ}C$, unless otherwise noted.

Efficiency

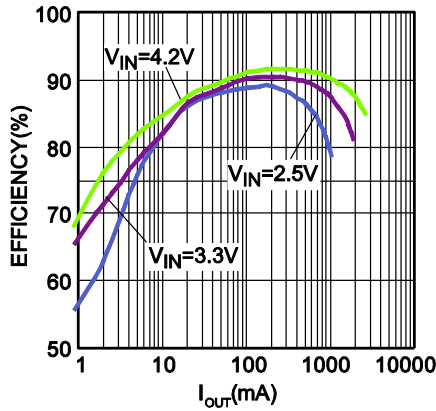

Load Regulation

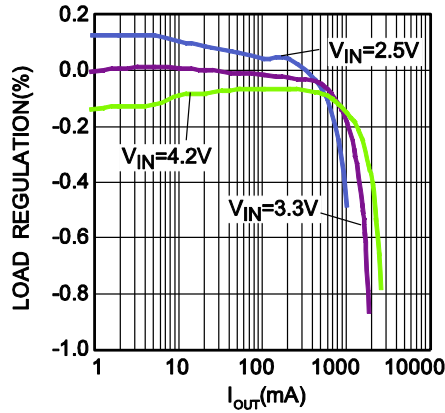

Line Regulation

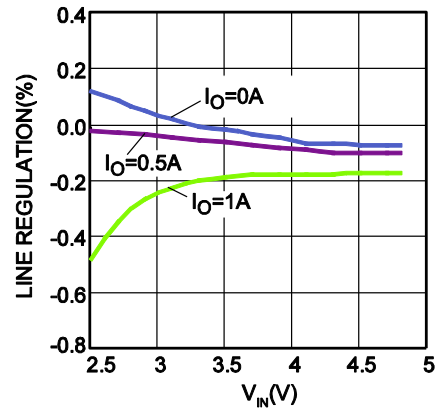

Max. Output Current Vs. Vin Voltage

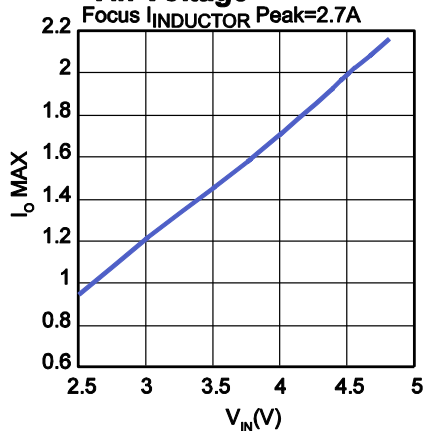

Current Limit vs. Temperature

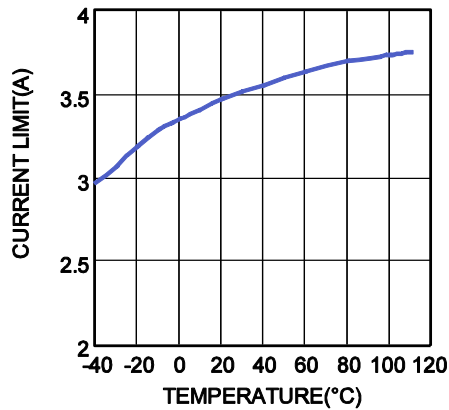

Current Limit vs. Duty

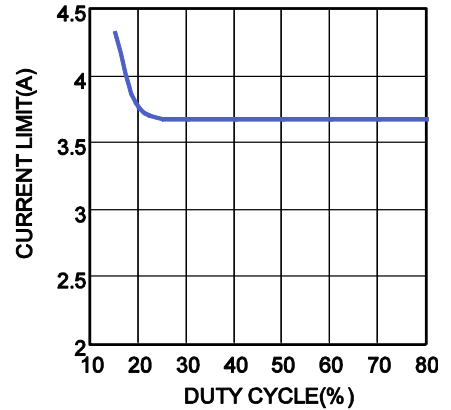

TYPICAL PERFORMANCE CHARACTERISTICS *(continued)*
 $V_{IN}=3.3V$, $V_{OUT}=5V$, $I_{OUT}=1A$, $T_A=25^{\circ}C$, unless otherwise noted.

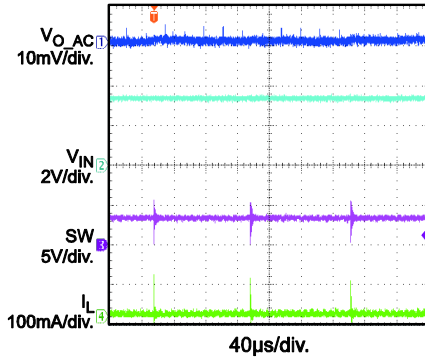
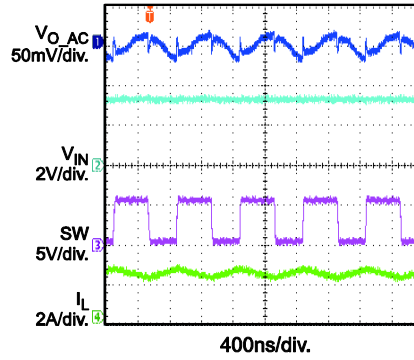
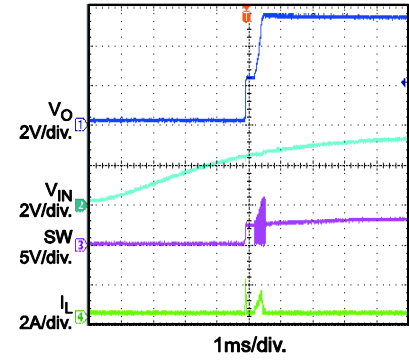
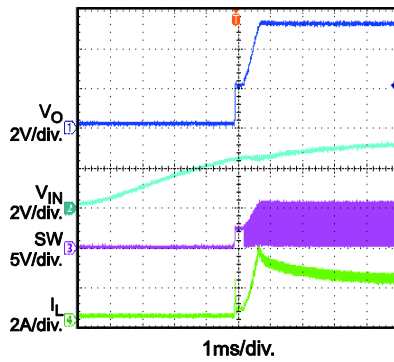
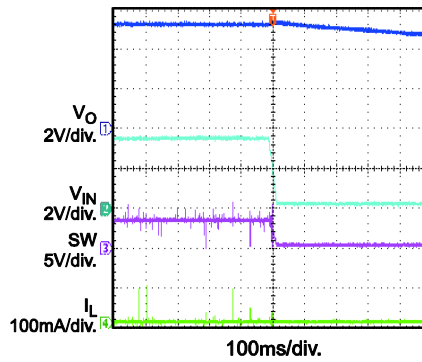
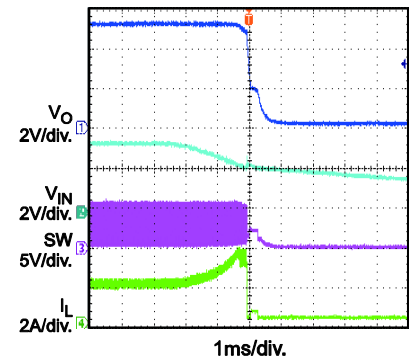
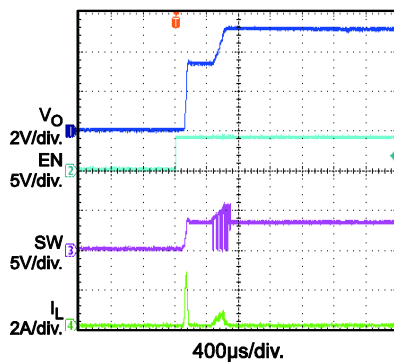
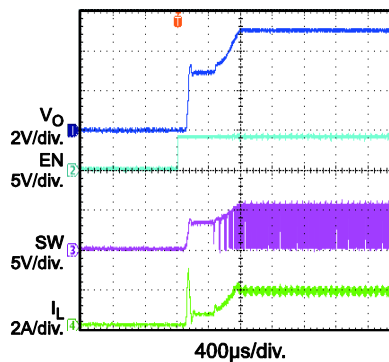
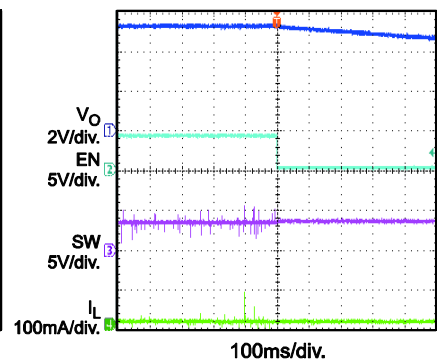
Steady state
 $V_{IN} = 3.3V$, $V_O = 5V/0A$

Steady state
 $V_{IN} = 3.3V$, $V_O = 5V/1A$

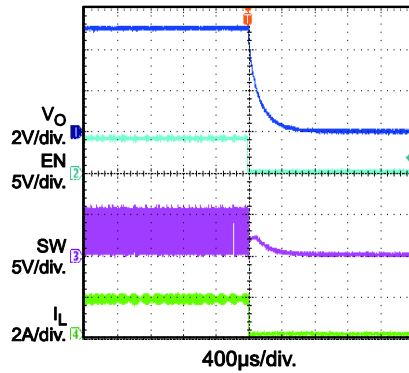
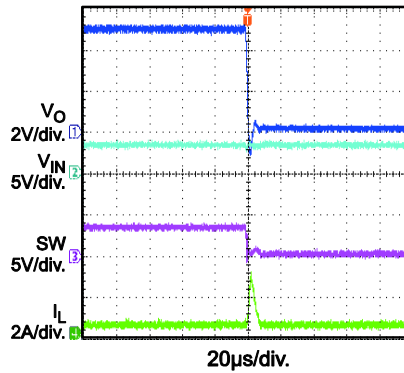
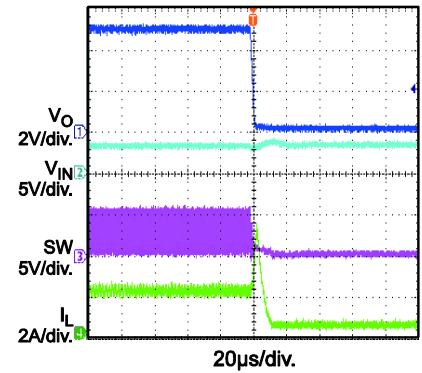
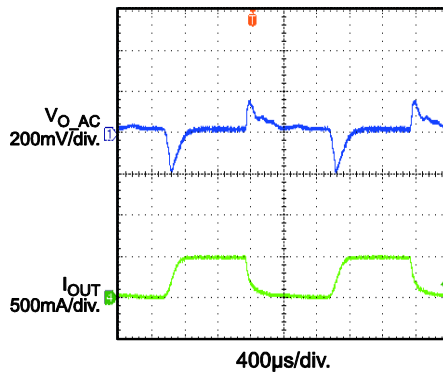
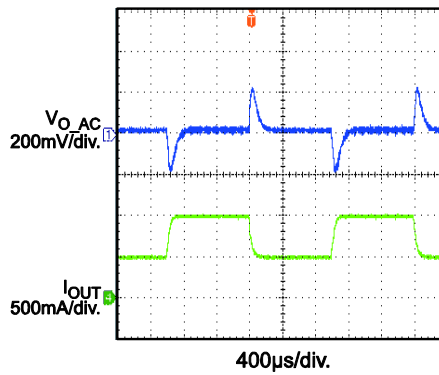
VIN startup
 $V_{IN} = 3.3V$, $V_O = 5V/0A$

VIN startup
 $V_{IN} = 3.3V$, $V_O = 5V/1A$

VIN shutdown
 $V_{IN} = 3.3V$, $V_O = 5V/0A$

VIN shutdown
 $V_{IN} = 3.3V$, $V_O = 5V/1A$

En startup
 $V_{IN} = 3.3V$, $V_O = 5V/0A$

En startup
 $V_{IN} = 3.3V$, $V_O = 5V/1A$

EN shutdown
 $V_{IN} = 3.3V$, $V_O = 5V/0A$

TYPICAL PERFORMANCE CHARACTERISTICS *(continued)*
 $V_{IN}=3.3V$, $V_{OUT}=5V$, $I_{OUT}=1A$, $T_A=25^{\circ}C$, unless otherwise noted.

EN shutdown
 $V_{IN} = 3.3V$, $V_O = 5V/1A$

SCP entry
 $V_{IN} = 3.3V$, $V_O = 5V/0A$ to short

SCP entry
 $V_{IN} = 3.3V$, $V_O = 5V/1A$ to short

Load transient
 $V_{IN} = 3.3V$, $V_O = 5V$,
 $I_O=0A \rightarrow 0.5A$ | ramp=10mA/ μ s

Load transient
 $V_{IN} = 3.3V$, $V_O = 5V$,
 $I_O=0.5A \rightarrow 1A$ | ramp=10mA/ μ s

PRINTED CIRCUIT BOARD LAYOUT

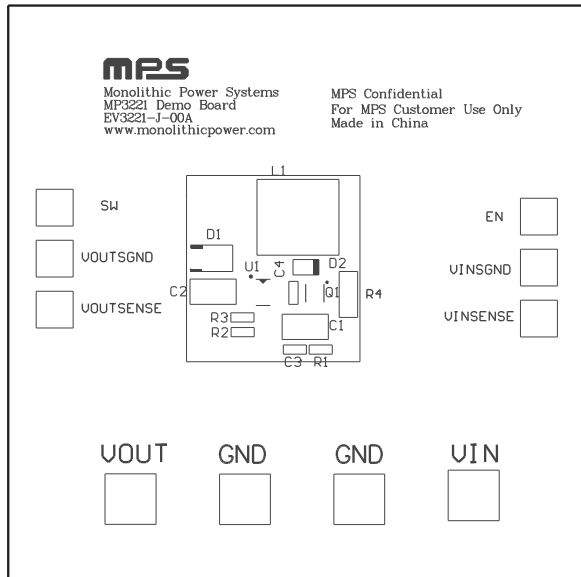

Figure 1: Top Silk Layer

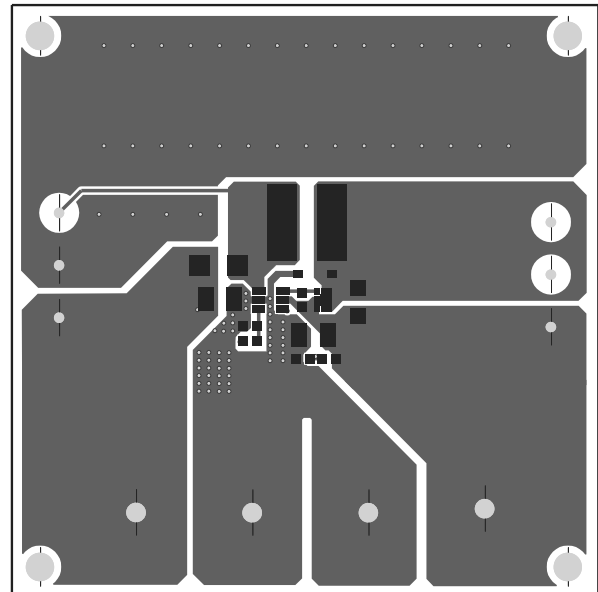

Figure 2: Top Layer

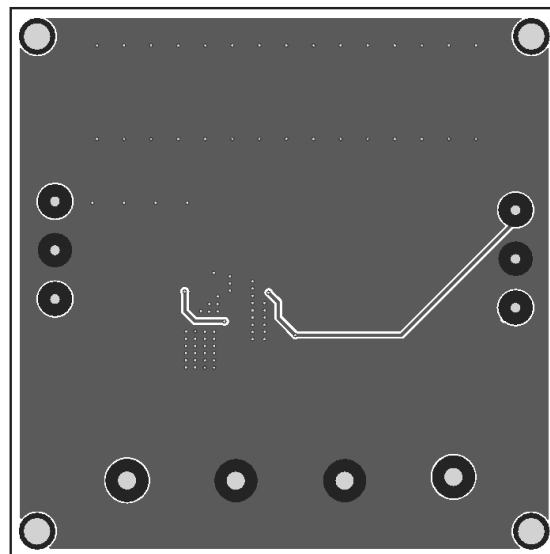

Figure 2: Bottom Layer

QUICK START GUIDE

1. Connect the positive and negative terminals of the load to the VOUT and GND pins respectively.
2. Preset the power supply output between 2.5V and 4.8V, and then turn off the power supply.
3. Connect the positive and negative terminals of the power supply output to the VIN and GND pins, respectively.
4. Turn the power supply on. The M3221 will automatically startup.
5. To use the Enable function, apply a digital input to the EN pin. Drive EN higher than 1.3V to turn on the regulator or less than 0.5V to turn it off.
6. Use R2 and R3 to set the output voltage with $V_{FB} = 0.8V$. Follow the Application Information section in the device datasheet to select the proper value of R2, R3, inductor and output capacitor values when output voltage is changed.

NOTICE: The information in this document is subject to change without notice. Users should warrant and guarantee that third party Intellectual Property rights are not infringed upon when integrating MPS products into any application. MPS will not assume any legal responsibility for any said applications.