

DESCRIPTION

The MP28200 is a monolithic power management unit containing 200mA high efficiency step-down switching. The sub microampere quiescent current provides extremely high efficiency when load current is low down to uA range. With the input range up to 5.5V, the MP28200 is ideal for powering battery-powered devices.

The constant-on-time control scheme provides fast transient response, high light load efficiency as well as the minimum capacitors.

The regulation is tight by integrating an error amplifier to correct the output voltage.

The CTRL pins control the ON/OFF and output voltage selection function.

Fault condition protection includes UVLO, over current protection, and thermal shutdown.

The MP28200 requires a minimum number of readily available standard external components and is available in a small QFN12 (2x2mm) package.

ELECTRICAL SPECIFICATION

Parameter	Symbol	Value	Units
Input Voltage	V_{IN}	2.0 – 5.5	V
Output Voltage	V_{OUT}	Table 1	
Output Current	I_{OUT}	0.2	A

Note: $V_{IN} < 3.3V$ may need more input capacitor.

FEATURES

- Ultra Low IQ: 500nA
- Wide 2.0V to 5.5V Operating Input Range
- 7 Selectable Output Voltages
- Up to 200mA Output Current
- 1.5MHz Switching Frequency at CCM Mode
- 100% Duty Cycle in Dropout
- 0.25Ω and 0.25Ω Internal Power MOSFET Switches
- Cycle-by-Cycle Over Current Protection
- Short Circuit Protect with Hiccup Mode
- Over Temperature Protection
- Available in a QFN12-2.0mmx2.0mm Package

APPLICATIONS

- Wearables
- IOT
- Portable Instruments
- Battery-Powered Devices

All MPS parts are lead-free, halogen free, and adhere to the RoHS directive. For MPS green status, please visit MPS website under Quality Assurance.

"MPS" and "The Future of Analog IC Technology" are Registered Trademarks of Monolithic Power Systems, Inc.

EV28200-G-00A EVALUATION BOARD



(L x W) 6.3cm x 6.3cm

Board Number	MPS IC Number
EV28200-G-00A	MP28200GG

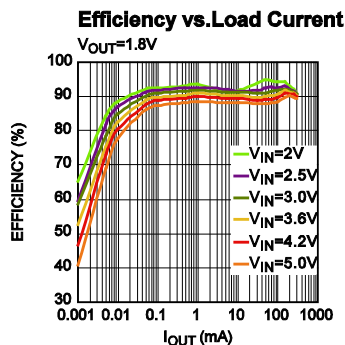

EVALUATION BOARD SCHEMATIC

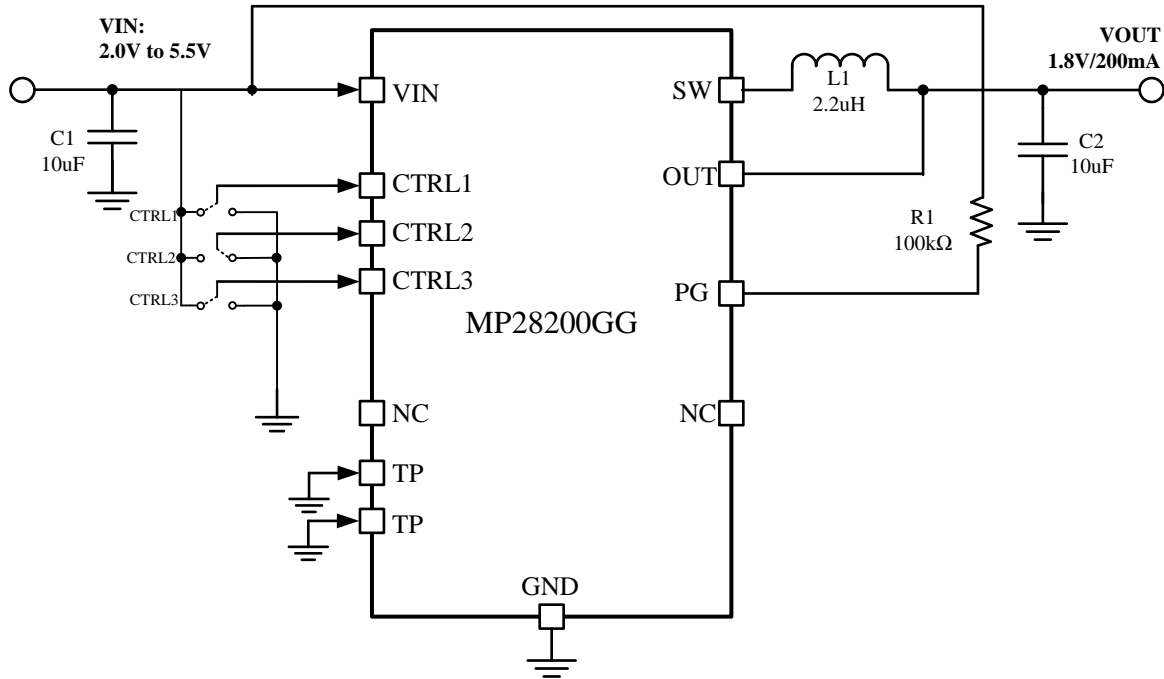

Figure 1. Typical Application Circuit for MP28200GG

Note: $V_{IN} < 3.3V$ may need more input capacitor.

EV28200GG-00A BILL OF MATERIALS

Qty	RefDes	Value	Description	Package	Manufacturer	Manufacturer P/N
2	C1,C2	10 μ F	Ceramic Cap,6.3V,X5R	0603	muRata	GRM188R60J106ME47D
1	R1	100k	Film Res.1%	0603	ROYALOHM	F1003T5E
1	L1	2.2 μ H	Inductor, Isate=2.1A, Rdc=144m Ω	2016	muRata	DFE201612P-2R2M
1	U1		Step-down Switcher	QFN12-2x2mm	MPS	MP28200GG
3	CTRL1, CTRL2, CTRL3,				Würth	450301014042

EVB TEST RESULTS

Performance waveforms are tested on the evaluation board.

$V_{IN}=3.6V$, $V_{OUT}=1.8V$, $L_1=2.2\mu H$, $C_{IN}=10\mu F$, $C_{OUT}=10\mu F$, $T_A = +25^\circ C$, unless otherwise noted.

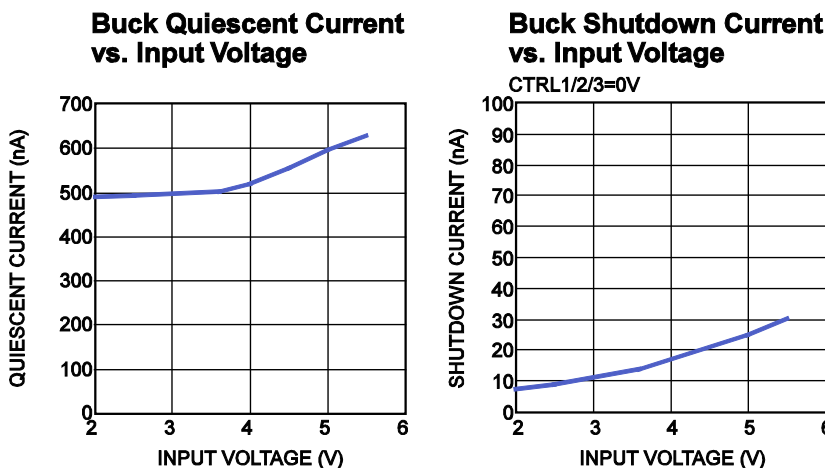
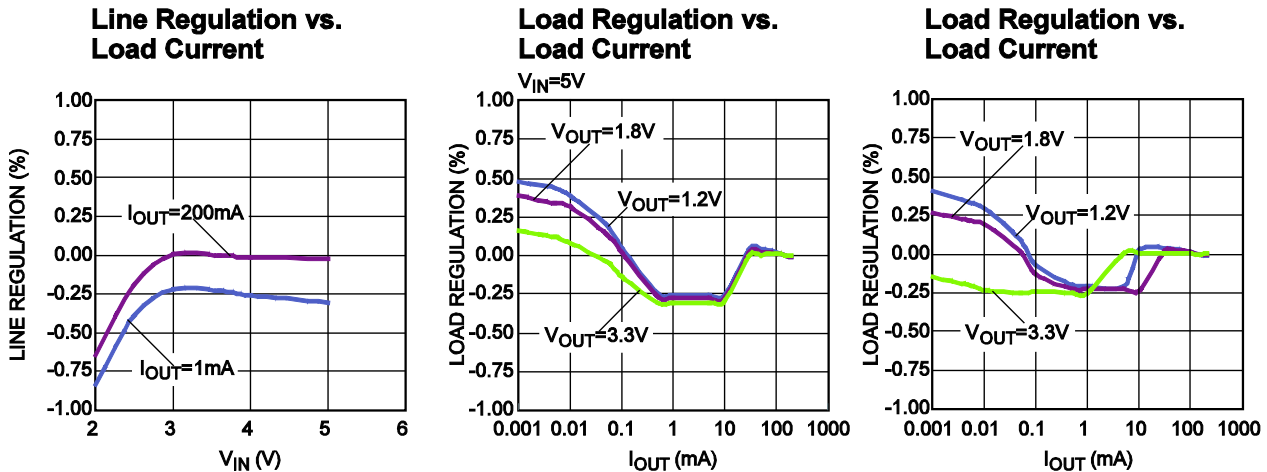
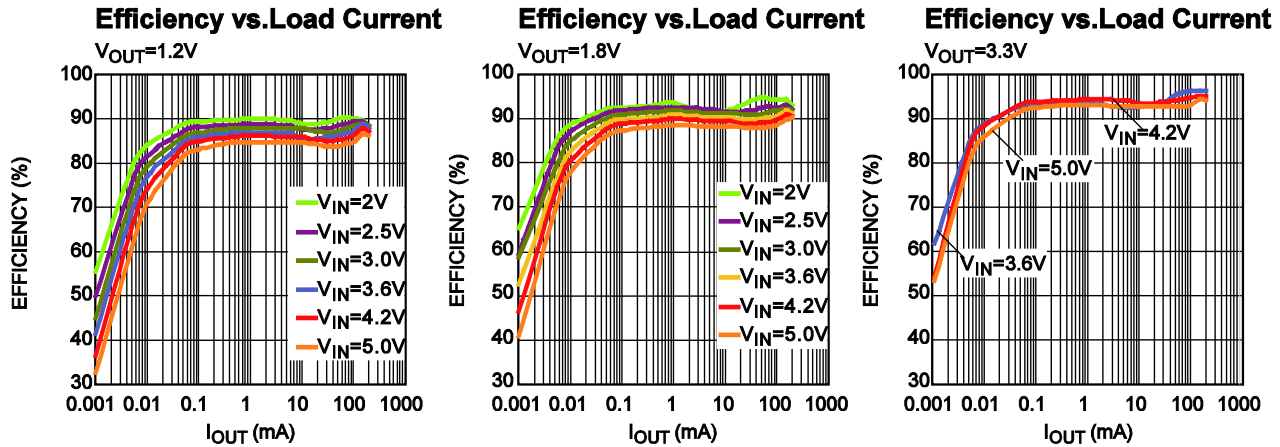

EVB TEST RESULTS (continued)

Performance waveforms are tested on the evaluation board.

$V_{IN}=3.6V$, $V_{OUT}=1.8V$, $L_1=2.2\mu H$, $C_{IN}=10\mu F$, $C_{OUT}=10\mu F$, $T_A = +25^\circ C$, unless otherwise noted.

Buck VIN UVLO Rising Threshold vs. Temperature

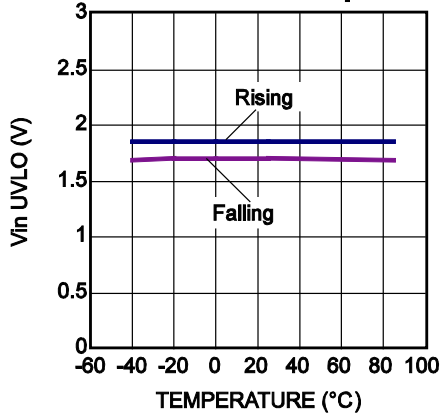

CTRL Rising and Falling Threshold vs. Temperature

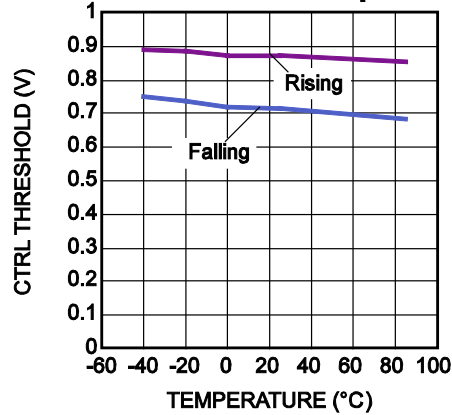

Reference Voltage vs. Temperature

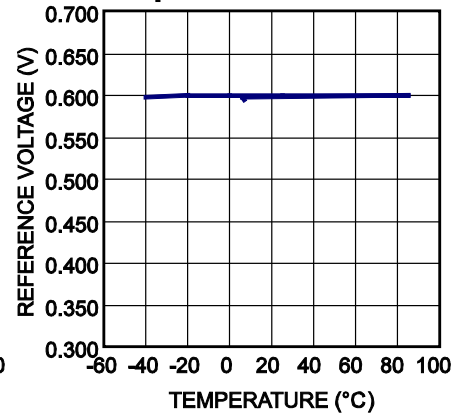

Frequency vs. Temperature

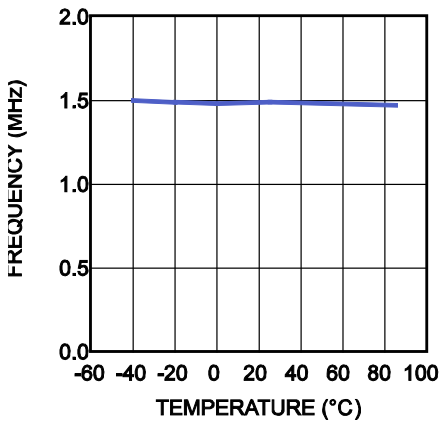

T_{RISE} vs. Output Current
 $V_{IN}=5V$

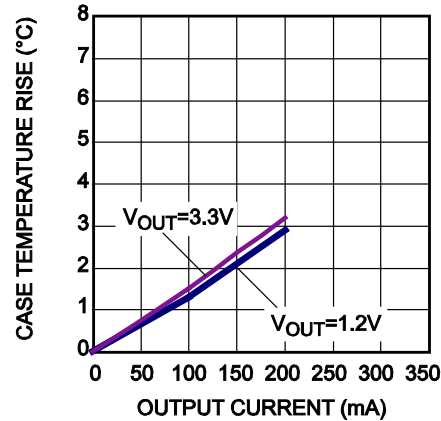

Output Current Derating vs. Ambient Temperature

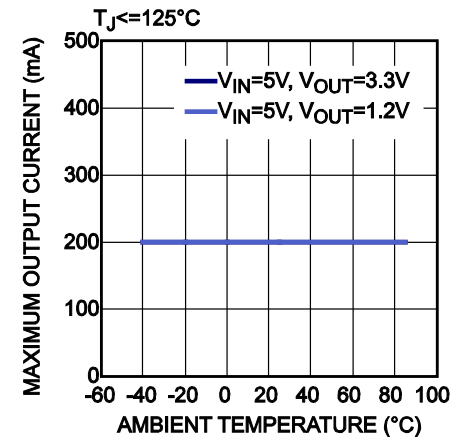

EVB TEST RESULTS (continued)

Performance waveforms are tested on the evaluation board.

$V_{IN}=3.6V$, $V_{OUT}=1.8V$, $L_1=2.2\mu H$, $C_{IN}=10\mu F$, $C_{OUT}=10\mu F$, $T_A = +25^\circ C$, unless otherwise noted.

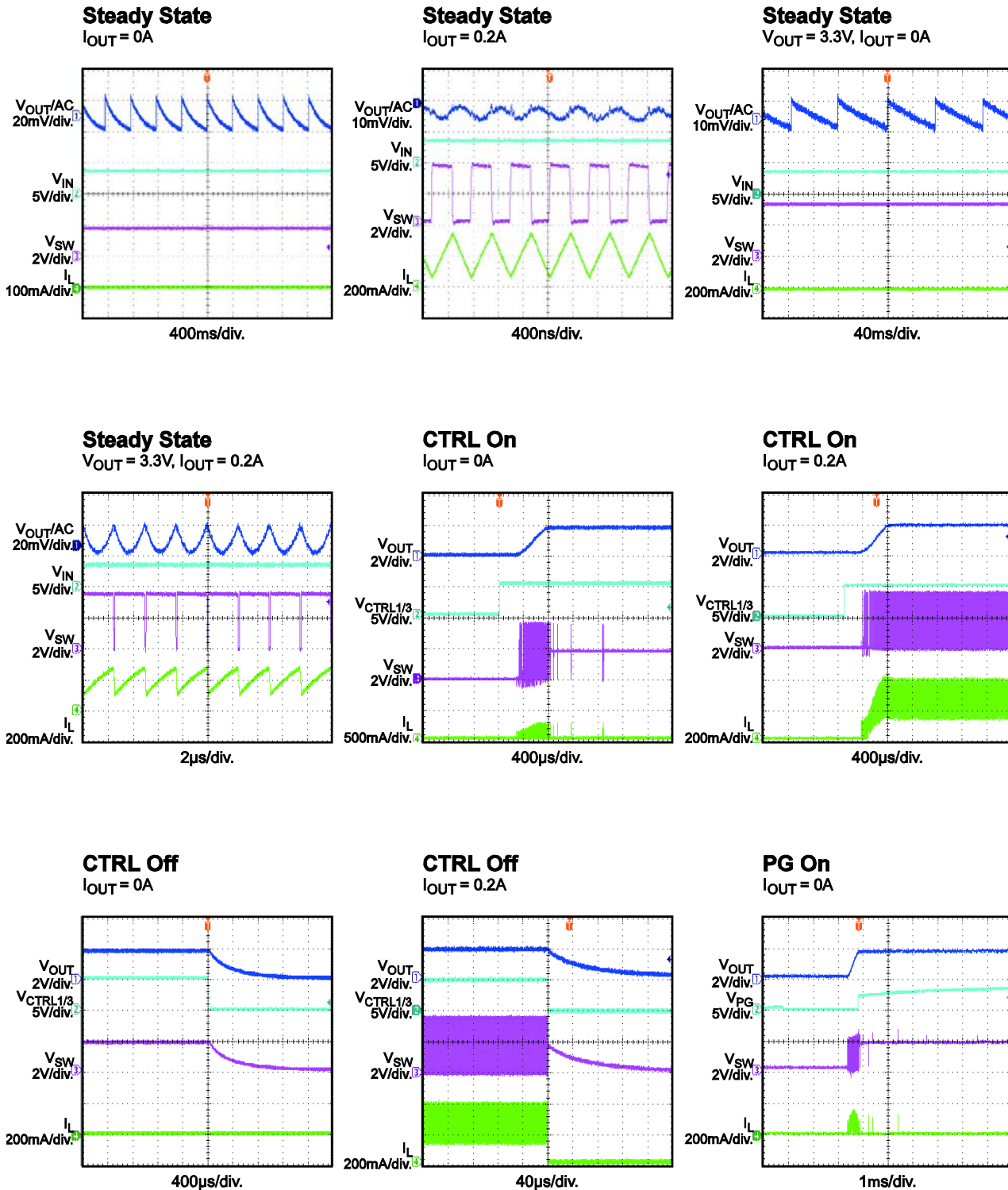

EVB TEST RESULTS (continued)

Performance waveforms are tested on the evaluation board.

$V_{IN}=3.6V$, $V_{OUT}=1.8V$, $L_1=2.2\mu H$, $C_{IN}=10\mu F$, $C_{OUT}=10\mu F$, $T_A = +25^\circ C$, unless otherwise noted.

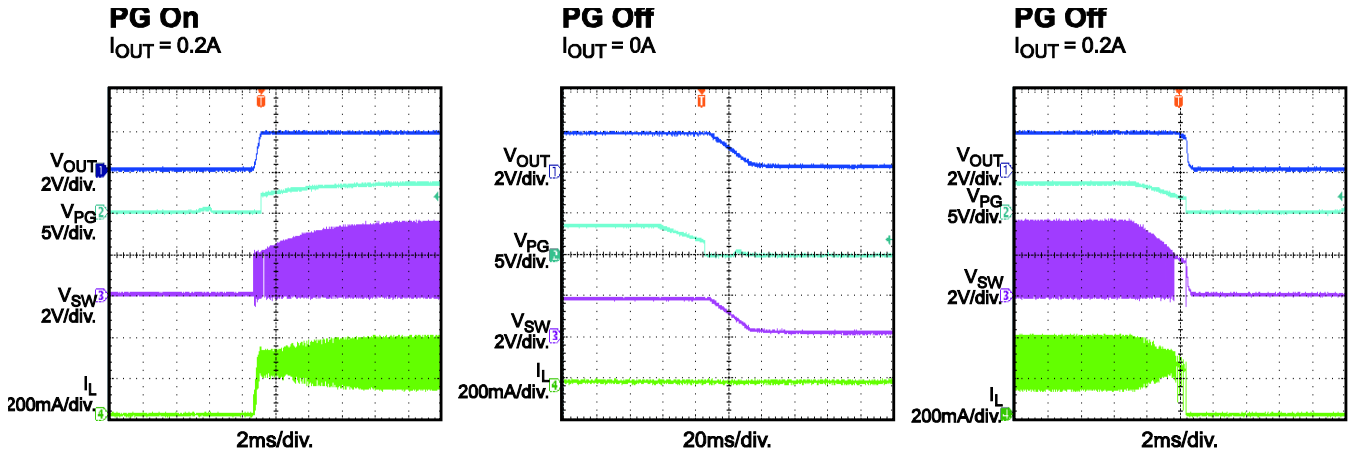

Load Transient
 $I_{OUT} = 30-200mA$, $0.25A/\mu s$

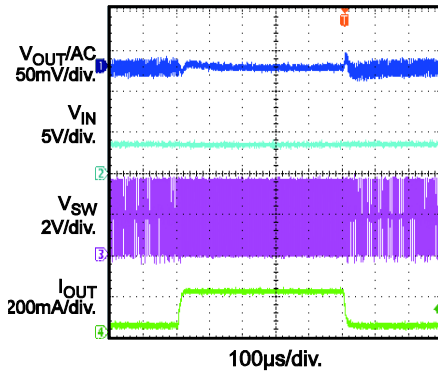

Load Transient
 $I_{OUT} = 100-200mA$, $0.25A/\mu s$

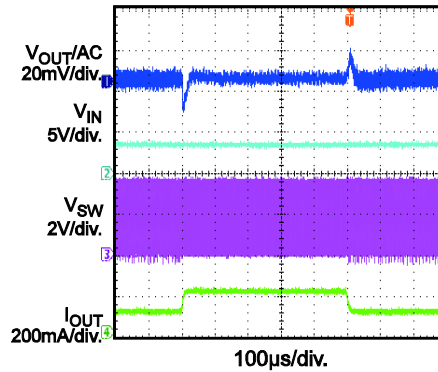

Short-Circuit Entry

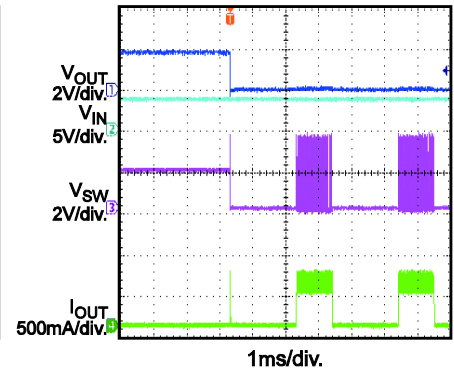

Short-Circuit Steady

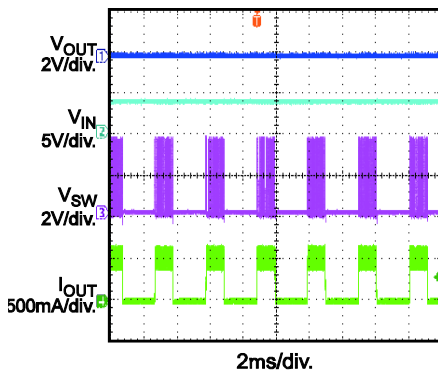

Short-Circuit Recovery

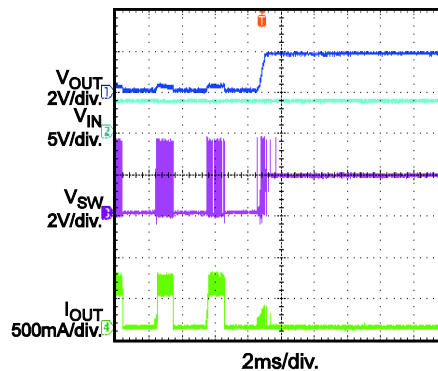

PRINTED CIRCUIT BOARD LAYOUT

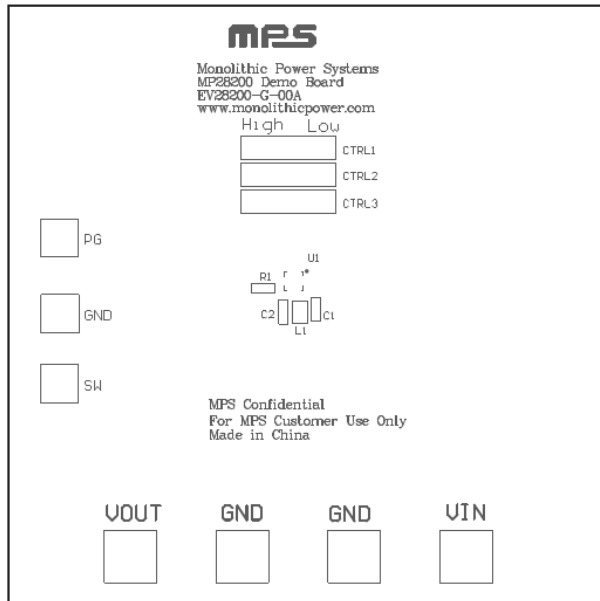

Figure 2—Top Silk Layer

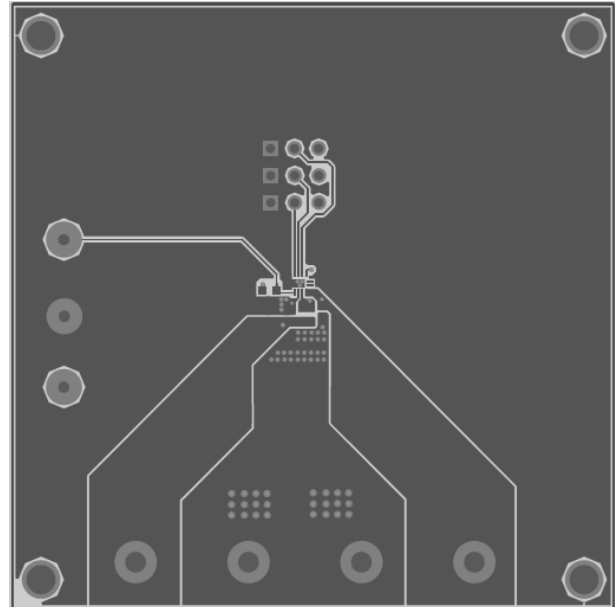

Figure 3—Top Layer

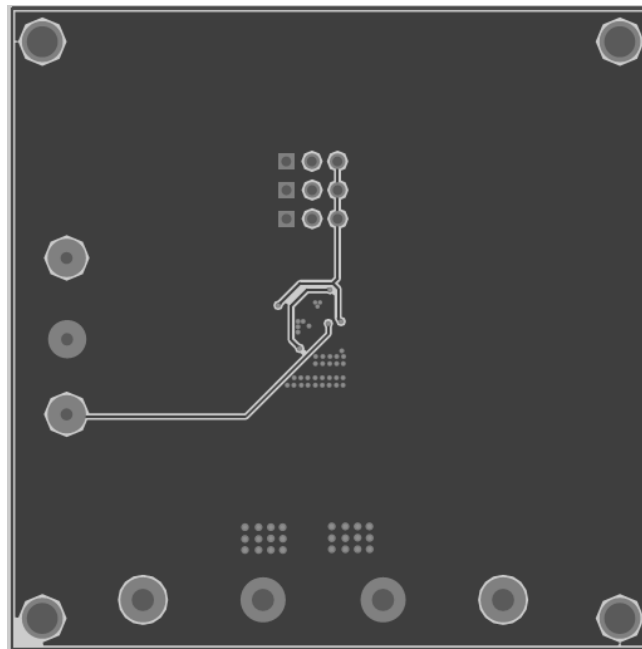

Figure 4—Bottom Layer

QUICK START GUIDE

The output voltage of this board is set by Table1. When switcher turns to high, relative CTRL pin connects to Vin; when switcher turns to low, CTRL pin connects to GND.

1. Connect the positive and negative terminals of the load to the VOUT and GND pins, respectively.
2. Preset the power supply output between 2.0V and 5.5V, and then turn off the power supply.
3. Connect the positive and negative terminals of the power supply output to the VIN and GND pins, respectively. Ton on the power supply.
4. According to Table1, turn on relative switchers(CTRL) to test voltage. The board will automatically start up.
5. Swith to different ouput voltage only need move relative switcher directly.

Table 1 CTRL vs. Output Voltages

CTRL3	CTRL2	CTRL1	OUT1
0	0	0	Disabled
0	0	1	0.8V
0	1	0	1.0V
0	1	1	1.2V
1	0	0	1.5V
1	0	1	1.8V
1	1	0	2.5V
1	1	1	3.3V

NOTICE: The information in this document is subject to change without notice. Please contact MPS for current specifications. Users should warrant and guarantee that third party Intellectual Property rights are not infringed upon when integrating MPS products into any application. MPS will not assume any legal responsibility for any said applications.