



EV2664-G-00A

Evaluation Board of 500mA Linear Charger with Power Path Management for Single-Cell Li-Ion Battery in QFN package

DESCRIPTION

The EV2664-G-00A is an evaluation board for the MP2664, a highly-integrated single-cell Li-Ion/Li-Polymer battery charger with system power path management, targeted at space limited portable applications. It takes input power from either an AC adapter or a USB port to supply the system load and charge the battery independently. The charger section features constant current pre charge (PRE.C), constant current fast charge (CC) and constant voltage (CV) regulation, charge termination and charge status.

EV2664 ensures the continuous power to the system by automatically selecting the input, the battery or both to power the system.

EV2664 provides system short circuit protection to prevent the Li-Ion battery from being damaged due to excessive high current.

EV2664 cuts off the path between battery and system when battery UVLO to prevent the Li-Ion battery from being overly discharged.

Through the I2C connector on EV2664, the customer can program the charging parameters, such as: input current limit, input minimum voltage regulation, charging current, battery regulation voltage, and battery UVLO.

ELECTRICAL SPECIFICATION

Parameter	Symbol	Value	Units
Input Voltage	V _{IN}	4.35 - 5.5	V
Battery Voltage	V _{BATT}	3.60 - 4.545	V
Input Current Limit	I _{IN_LIM}	85 - 455	mA
Input Minimum Voltage Regulation	V _{IN_MIN}	V _{BATT} +400mV	V
Charge Current	I _{CC}	8 - 535	mA
Discharge Current	I _{DSCHG}	400 - 3200	mA

FEATURES

- Fully Autonomous Charger for Single-Cell Li-Ion/Polymer Batteries
- Current Limit for USB Port
- Complete Power Path Management for Simultaneously Powering the System and Charging the Battery
- 0.5% Charging Voltage Accuracy
- 13V Maximum Voltage for the Input Source
- I²C Interface for Setting charging Parameters and Status Reporting
- Robust Charging Protection Including Battery Temperature Monitor and Programmable Timer
- Battery Disconnection Function

APPLICATIONS

- Wearable devices
- Smart Handheld Devices
- Fitness Accessories
- Smart Watches

All MPS parts are lead-free, halogen free, and adhere to the RoHS directive. For MPS green status, please visit MPS website under Quality Assurance. "MPS" and "The Future of Analog IC Technology" are Registered Trademarks of Monolithic Power Systems, Inc.

EVALUATION BOARD SCHEMATIC

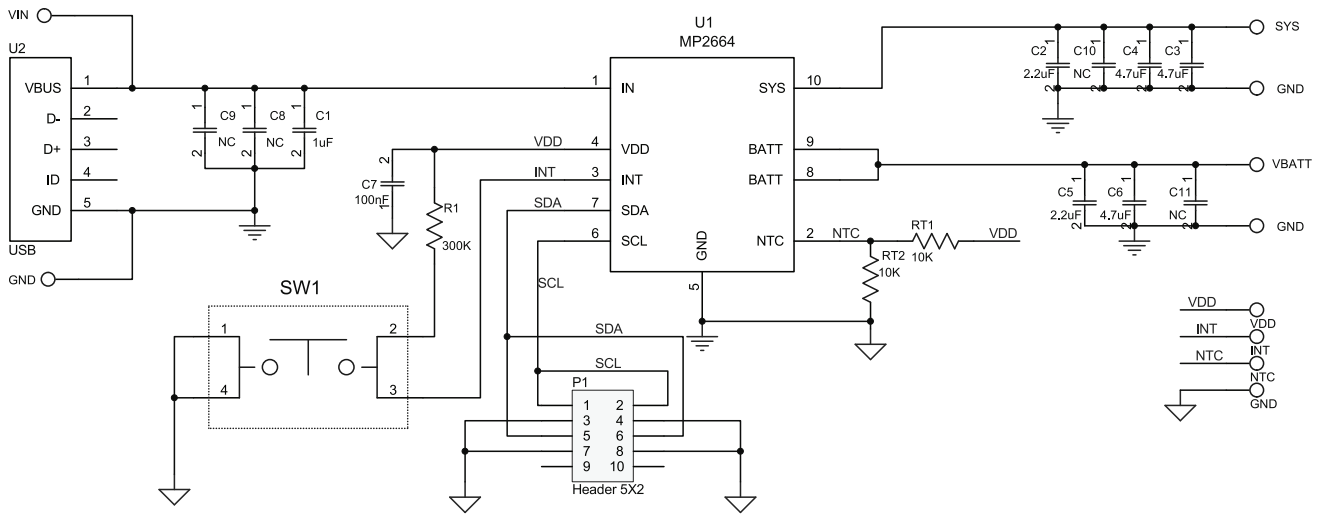

EV2664-G-00A BILL OF MATERIALS

Qty	Ref	Value	Description	Package	Manufacture	Manufacture_PN
1	C1	1 μ F	Ceramic Cap;25V; X7R;0603;	0603	muRata	GRM188R71E105KA12D
2	C5, C2	2.2 μ F	Ceramic Cap;25V; X7R;0805;	0805	muRata	GRM21BR71E225KA73L
2	C8, C10	NC	Ceramic Cap;25V; X7R;0805;	0805	muRata	GRM21BR71E225KA73L
3	C3, C4, C6	4.7 μ F	Ceramic Cap;25V; X7R;1206	1206	muRata	GRM31CR71E475KA88L
1	C7	100nF	Ceramic Cap;25V; X7R;0805;	0805	HHEC	C0805X104K025T
2	C9, C11	NC	Ceramic Cap;25V; X7R;1206	1206	muRata	GRM31CR71E475KA88L
1	P1		Header, 5-Pin, Dual row			
1	R1	300k	Film Resistor;1%;	0603	Yageo	RC0603FR-07300KL
2	RT1, RT2	10k	Film Resistor;1%;	0603	Yageo	RC0603FR-0710KL
1	U2		Micro-B USB connector;			
1	U1		IC;2mm*2mm	QFN-10	MPS	MP2664GG-0000

PRINTED CIRCUIT BOARD LAYOUT

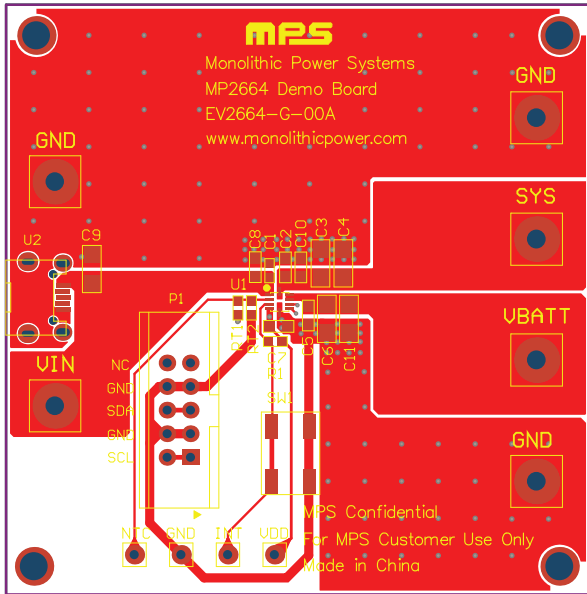

Figure 1: Top Layer

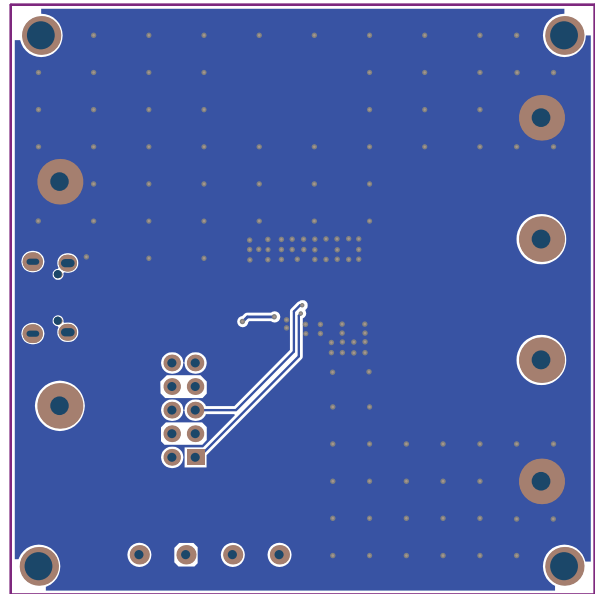

Figure 2: Bottom Layer

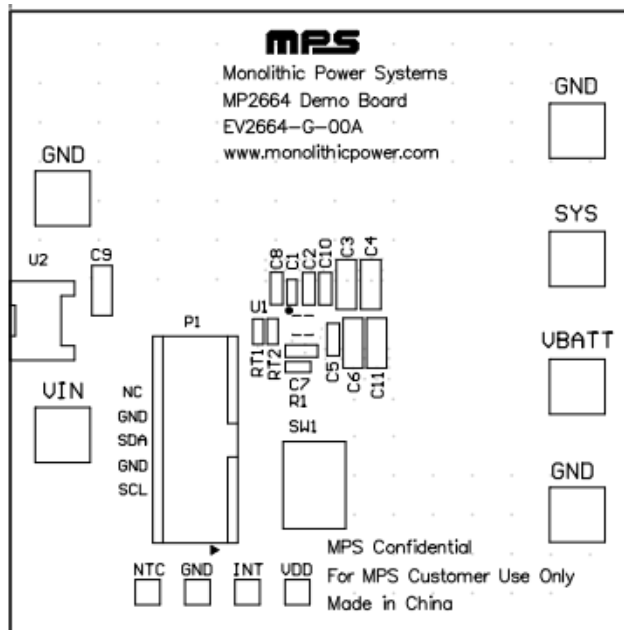

Figure 3: Top Silk Layer

QUICK START GUIDE

This board is designed for MP2664 which is a highly-integrated single-cell Li-Ion/Li-Polymer battery charger with system power path management function. And layout accommodates most commonly used capacitors. The default function of this board is preset for charger mode and the charge full voltage is preset to 4.200V for 1 cell Li-Ion battery.

Evaluation Platform Preparation:











- 1) A computer with at least one USB port and a USB cable. The MP2664 evaluation software must be properly installed.
- 2) USB-to-I²C Communication Kit (EVKT-USBI2C-02)



Figure 4: USB-to-I²C Communication Kit

- 3) Software - Double-click on the “MP2664 Evaluation Kit” EXE file to run the MP2664 evaluation software. The software supports the Windows® XP and Windows 7 operating systems. The MP2664 Evaluation Kit EXE file is available on MPS website:

<http://mps-ebench/InstallationFile.aspx?categoryID=7>

GUI		
Show 10 entries		
Name	Description	Download
Magnet	sensima	
MP2624	Charge	
MP2638 Evaluation Kit	I2C evaluation kit software for MP2638, V1.1.7.	
MP2638A Evaluation Kit	Evaluation kit for MP2638A, V1.0. Parts supported: MP2638A.	
MP2650	for Charge group	
MP2660 Evaluation Kit	I2C evaluation kit software for MP2660, V1.6.7. Parts supported: MP2660.	
MP2661 Evaluation Kit	I2C evaluation kit software for MP2661, V1.1.5. Parts supported: MP2661.	
MP2663 Evaluation Kit	I2C evaluation kit software for MP2663, V1.0. Parts supported: MP2663.	
MP2664 Evaluation Kit	I2C evaluation kit software for MP2664, V1.1.	
MP2669 Evaluation Kit	I2C evaluation kit software for MP2669, V1.0.	

Previous 1 2 3 4 Next

Figure 5: MP2664 Evaluation Kit EXE file on Ebench

4) Original Test Setup for MP2664 in Figure 6

Attach the input voltage (VIN=5V) and the input ground to the VIN and GND pins, respectively.

Attach the positive and negative ends of the load to the SYS and GND pins, respectively.

Attach the positive and negative ends of the battery (VBATT=3-4.2V) to the BATT and GND pins, respectively.

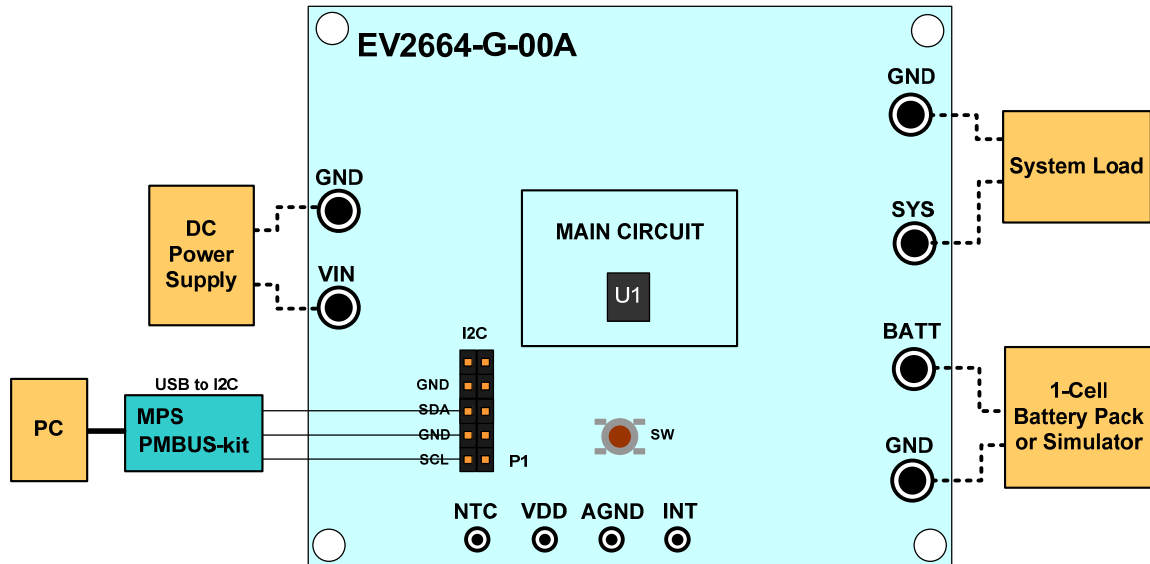

Figure 6: Test Setup for MP2664

5) Turn on the computer. Launch the MP2664 evaluation software. The main window of the software is shown in Figure 7.

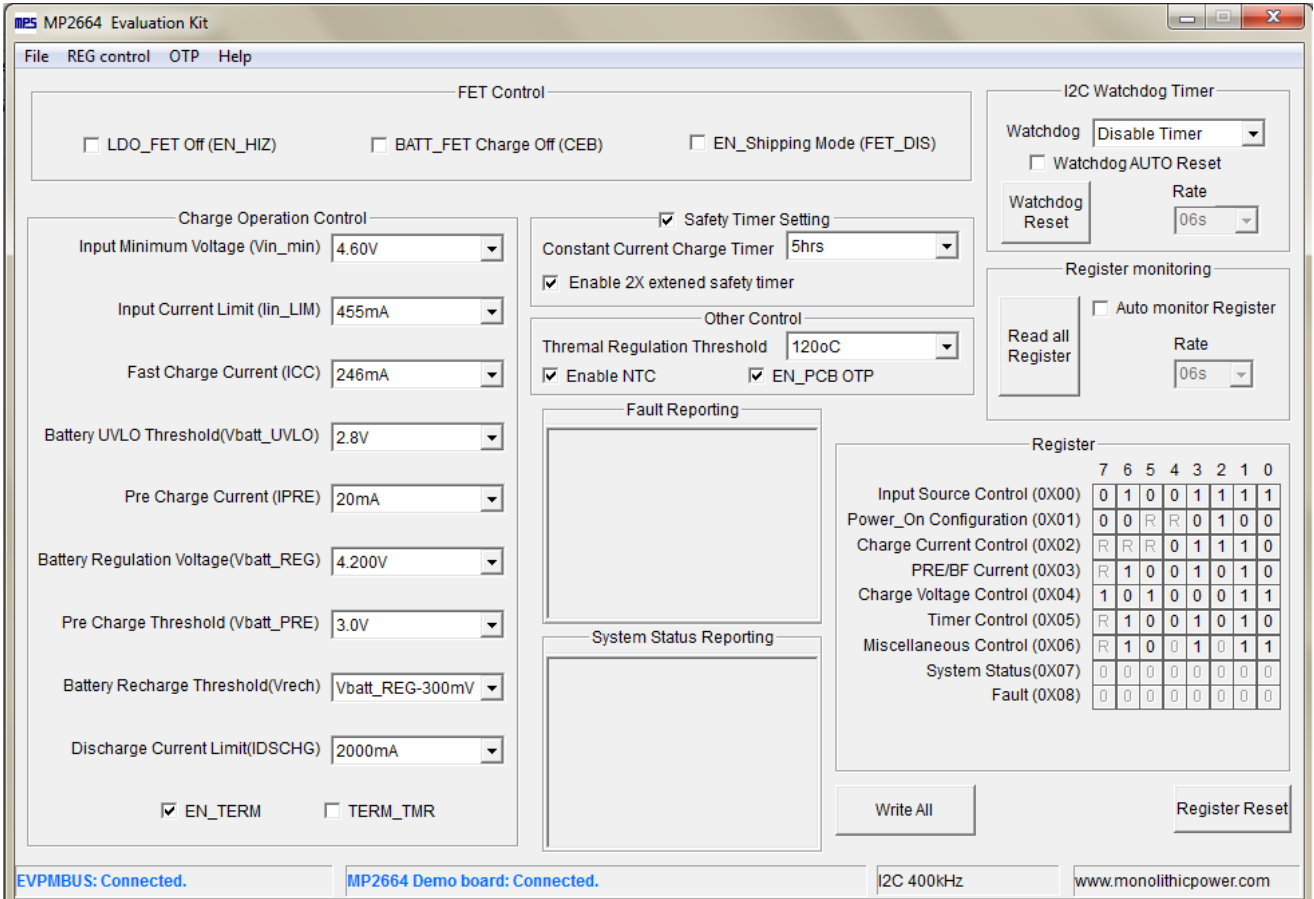

Figure 7: MP2664 evaluation interface

Procedure

Make sure all the connections are normal – both the USB-to-I2C Communication Kit and the EV2664-G-00A are connected correctly. It is ready to run the program!

Charger Function

Charge Operation Control

Input Minimum Voltage (Vin_min)

Input Current Limit (lin_LIM)

Fast Charge Current (ICC)

Battery UVLO Threshold(Vbatt_UVLO)

Pre Charge Current (IPRE)

Battery Regulation Voltage(Vbatt_REG)

Pre Charge Threshold (Vbatt_PRE)

Battery Recharge Threshold(Vrech)

Discharge Current Limit(IDSCHG)

EN_TERM TERM_TMR

1. Set Input Minimum Voltage at 4.60 V (the range is 3.88 - 5.08V)

Input Minimum Voltage (Vin_min)

4.60V

4.68V

4.76V

4.84V

4.92V

5.00V

5.08V

2. Set Input Current Limit to 455mA (the range is 85 – 455mA)

Input Current Limit (lin_LIM)

130mA

175mA

220mA

265mA

310mA

355mA

455mA

3. Set Fast Charge Current, ICC to 246mA (the range is 8 – 535mA)

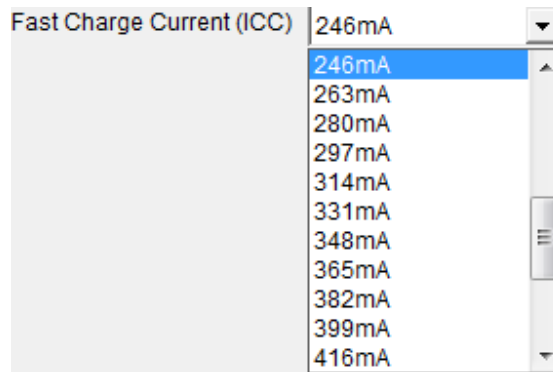

4. Set BATT UVLO threshold to 2.8V (the range is 2.4 – 3.1V)

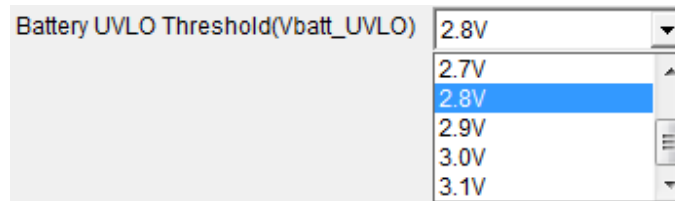

5. Set Pre Charge Current to 20mA (the range is 6 – 27mA)

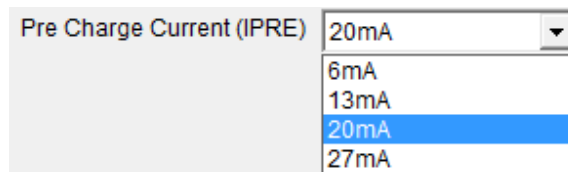

6. Set Battery Regulation Voltage to 4.200V (the range is 3.6 - 4.545V)

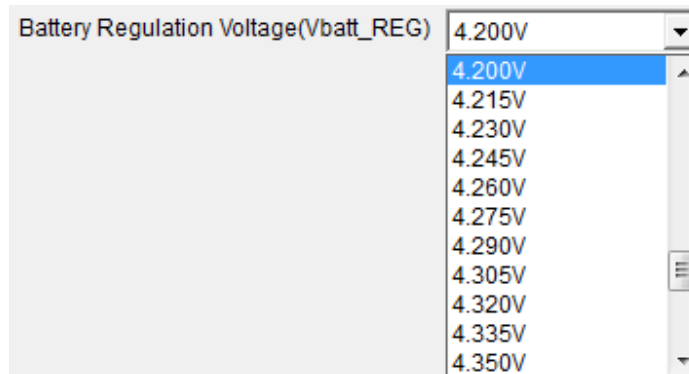

7. Set Pre - Charge to CC Charge Threshold Voltage to 3.0 V (the range is 2.8 – 3.0V)

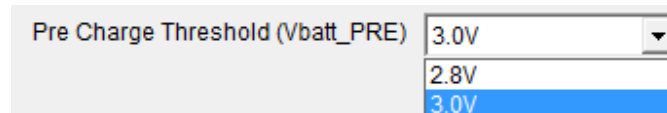

8. Set Battery Auto-recharge Voltage to Vbatt_REG – 300mV (the range is 150mV or 300mV)

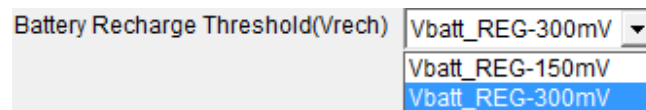

9. Set Battery Discharge Current Limit to 2000mA (the range is 400mA to 3200mA):

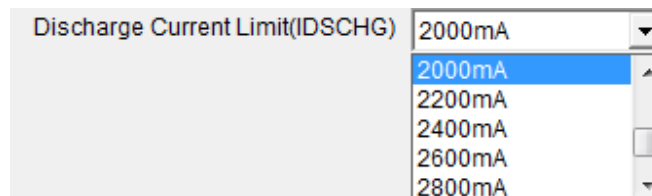

10. Termination Function Select

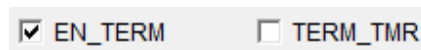

Table 1 Termination Function Selection Table

EN_TERM	TERM_TMR	After I _{BATT} hits I _{TERM} in CV mode	
		Operation	Charge Status
<input type="checkbox"/>	x	Keep CV Charge	Charge
<input checked="" type="checkbox"/>	<input type="checkbox"/>	Charge Done	Charge Done
<input checked="" type="checkbox"/>	<input checked="" type="checkbox"/>	Keep CV Charge	Charge Done

Others

1. LDO FET Control:

LDO_FET Off (EN_HIZ)

This bit only controls the on/off of the LDO FET.

2. BATT FET Control:

BATT_FET Charge Off (CEB) EN_Shipping Mode (FET_DIS)

CEB only control the on/off of the Battery FET in charge mode.

FET_DIS selected could turn off the Battery FET at both charge and discharge mode.

FET_DIS unselected could not turn on Battery FET; pull INT to low by push button could turn on Battery FET when it's turned off by FET_DIS.

3. Other Control.

Other Control

Thermal Regulation Threshold

Enable NTC EN_PCB OTP

Above setting enables PCB OTP; for other application, please refer to the table below.

Table 2 NTC Function Selection Table

Enable NTC	EN_PCB OTP	Function
<input type="checkbox"/>	x	Disable
<input checked="" type="checkbox"/>	<input type="checkbox"/>	NTC
<input checked="" type="checkbox"/>	<input checked="" type="checkbox"/>	PCB OTP

4. Safety Timer Setting

Safety Timer Setting

Constant Current Charge Timer

Enable 2X extened safety timer

5. I²C Watchdog Timer

I2C Watchdog Timer

Watchdog

Watchdog AUTO Reset

Watchdog Rate

Watchdog Reset

6. Resister Auto Monitor

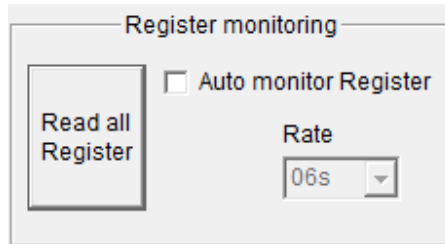

7. Content of the Registers:

Register	7	6	5	4	3	2	1	0
Input Source Control (0X00)	0	1	0	0	1	1	1	1
Power_On Configuration (0X01)	0	0	R	R	0	1	0	0
Charge Current Control (0X02)	R	R	R	0	1	1	1	0
PRE/BF Current (0X03)	R	1	0	0	1	0	1	0
Charge Voltage Control (0X04)	1	0	1	0	0	0	1	1
Timer Control (0X05)	R	1	0	0	1	0	1	0
Miscellaneous Control (0X06)	R	1	0	0	1	0	1	1
System Status(0X07)	0	0	0	0	0	0	0	0
Fault (0X08)	0	0	0	0	0	0	0	0

8. Monitor the MP2664 operation status and Fault report

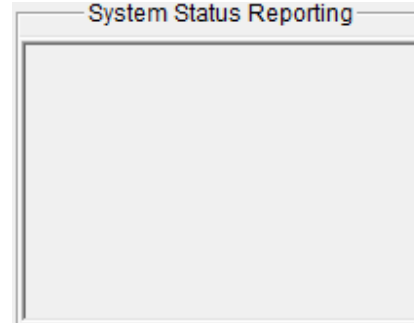
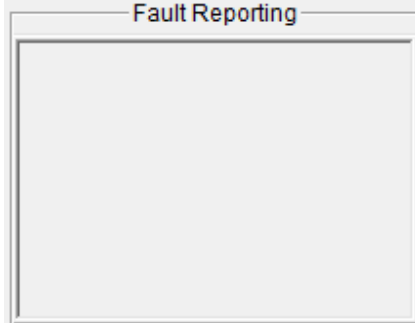

❖Notes❖

please contact local FAE to apply:

1. The latest datasheet to get the other detailed description on the operation of this part
2. The “MP2664 Evaluation Kit” EXE file

NOTICE: The information in this document is subject to change without notice. Please contact MPS for current specifications. Users should warrant and guarantee that third party Intellectual Property rights are not infringed upon when integrating MPS products into any application. MPS will not assume any legal responsibility for any said applications.