

DESCRIPTION

The EV2639A-R-00B is the reference design board for MP2639A, a highly-integrated, flexible switch-mode battery charge management for 2-cell series Li-ion and Li-Polymer battery used in a wide range of applications.

The demo board works in charge mode and allows management of system and battery power based on the state of the input.

When input power is present, the board charges a 2-cell series battery with 2.5A charge current.

The evaluation board provides 4-LED drivers to achieve the voltage based fuel gauge indication. To guarantee safe operation, the EV2639A-R-00B has input-over-voltage protection, battery over-voltage protection, thermal shutdown, battery-temperature monitoring, and a charge timer to prevent prolonged charging a dead battery.

ELECTRICAL SPECIFICATION

Parameter	Symbol	Value	Units
Charge Mode			
Input Voltage Range	V_{IN}	4 – 5.75	V
Charge-Full Voltage	V_{BATT_FULL}	8.4	V
Auto-recharge Voltage	V_{BATT_RC}	8	V
Charge Current	I_{CHG}	2.5	A
Input Current Limit	I_{IN_LIM}	3	A

FEATURES

- 4.0V-to-5.75V Input Voltage Range
- Charge 2- Cell Battery With 5V Input
- USB-compliant Charger
- Integrated Both Input-Current-Based and Input-Voltage-Based Power Management Function
- Input Current at 3A and Input Voltage Limit at 4.49V
- 2.5A Charge Current for 2-Cell Application
- 8.4V Charge Voltage with 0.5% Accuracy
- Negative Temperature Coefficient Pin for Temperature Monitoring
- Charge Timer Back-up Protection
- Thermal Regulation and Thermal Shutdown
- 4 LEDs Battery Level and Status Indication
- 4mmx4mm QFN-26 package

APPLICATIONS

- Power Station Applications
- Tablet and Other Portable Devices
- Mobile Internet Devices

All MPS parts are lead-free, halogen free, and adhere to the RoHS directive. For MPS green status, please visit MPS website under Quality Assurance.

"MPS" and "The Future of Analog IC Technology" are Registered Trademarks of Monolithic Power Systems, Inc.

EV2639A-R-00B EVALUATION BOARD

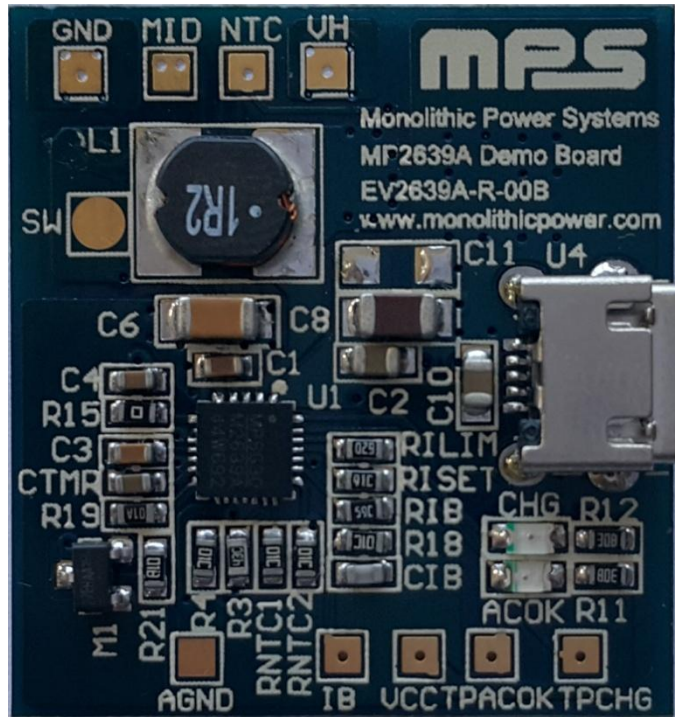

(L x W x H)
(3cm x 2.8cm x 0.16cm)

Board Number	MPS IC Number
EV2639A-R-00B	MP2639AGR

EVALUATION BOARD SCHEMATIC

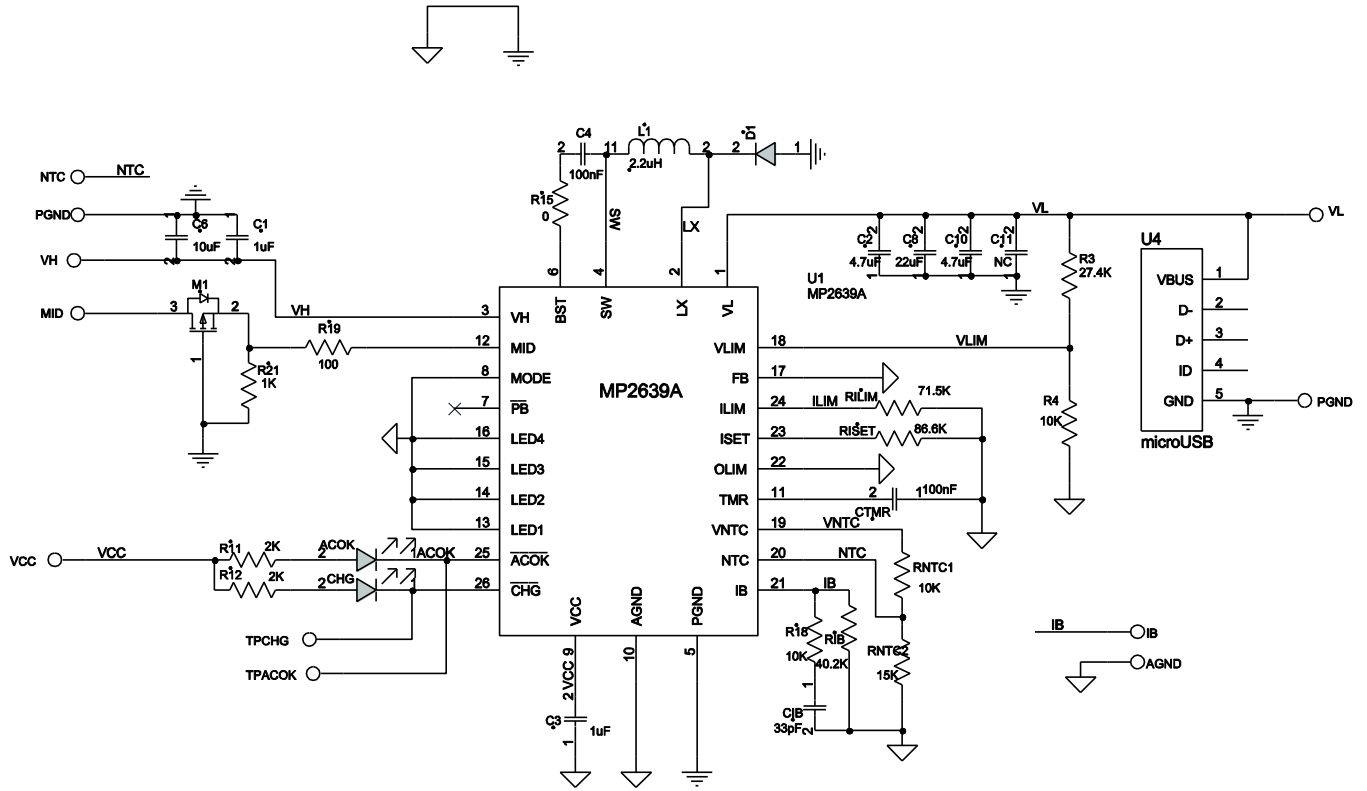

RILIM = 432K for 500mA ILIM, RILIM = 71.5K for 3A ILIMIT, RILIM=640K/3/ILIM
 RISET = 88.8K for 2.46A ICHG, RISET=640K/3/ICHG

EV2639A-R-00B BILL OF MATERIALS

Qty	Ref	Value	Description	Package	Manufacturer	Part Number
1	R3	27.4k	Film Resistor;1%	0603	Yageo	RC0603FR-0727K4L
3	R4, R18, RNTC1	10k	Film Resistor;1%	0603	Yageo	RC0603FR-0710KL
1	RNTC2	15k	Film Resistor;1%	0603	Yageo	RC0603FR-0715KL
2	R11, R12	2k	Film Resistor;1%;	0603	Yageo	RC0603FR-072KL
1	R15	0	Film Resistor;5%;	0603	Yageo	RC0603FR-070RL
1	R19	100	Film Resistor;1%;	0603	Yageo	RC0603FR-07100RL
1	R21	1k	Film Resistor;1%;	0603	Yageo	RC0603FR-071KL
1	RIB	40.2k	Film Resistor;1%;	0603	Yageo	RC0603FR-0740K2L
1	RILIM	79k	Film Resistor;1%	0603	Yageo	RC0603FR-0779KL
1	RISSET	86.6k	Film Resistor;1%	0603	Yageo	RC0603FR-0786K6L
2	C1, C3	1 μ F	Ceramic Capacitor; 25V;X7R	0603	muRata	GRM188R71E105KA12D
2	C2, C10	4.7 μ F	Ceramic Capacitor; 25V;X5R	0805	muRata	GRM21BR61E475KA12L
2	C4, CTMR	100nF	Ceramic Capacitor; 25V;X7R	0603	muRata	GRM188R71E104KA01D
1	C6	10 μ F	Capacitor;25V;X7R	1206	muRata	GRM31CR71E106KA12
1	C8	22 μ F	Capacitor;16V;X7S	1206	Murata	GRM31CC71C226ME11L
1	C11	NC				
1	C1B	33pF	Ceramic Capacitor; 50V;	0603	TDK	C1608C0G1H330J
1	CHG	BL-HUF35A- TRB	LED;green;	0805	BRIGHT LED	BL-HUF35A-TRB
1	ACOK,	BL-HGB35A- TRB	LED;red;	0805	BRIGHT LED	BL-HGB35A-TRB
1	D1	B330B	Schottky Diode; 30V;3A;	SMB	Diodes	B330B-13-F
1	L1	1.2 μ H	Inductor;1.2 μ H,21m, 4.6A	SMD	Würth	7447745012
1	M1	AM2305PE-T1	P-Channel Mosfet;- 20V;	SOT-23	Analog Power	AM2305PE-T1
1	U1				MPS	MP2639AGR
1	U4	microUSB			Würth	629105150521

PRINTED CIRCUIT BOARD LAYOUT

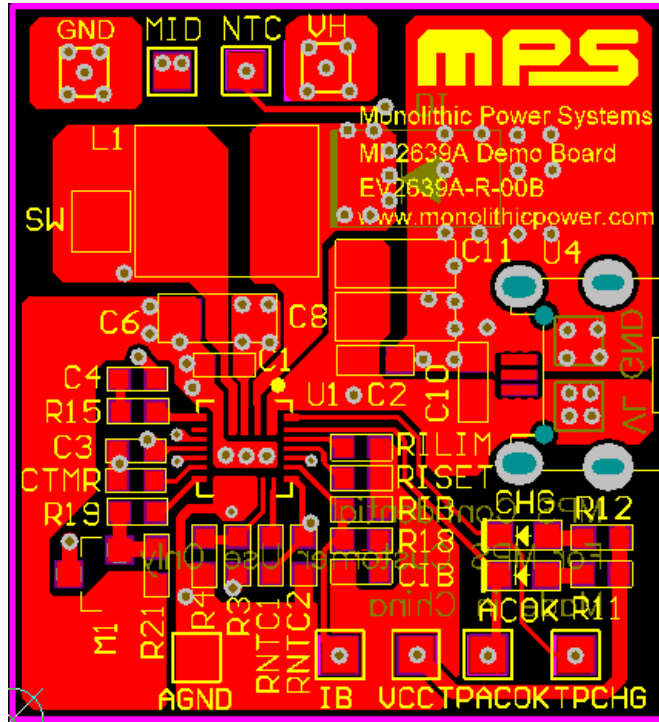

Figure 1: Top Layer

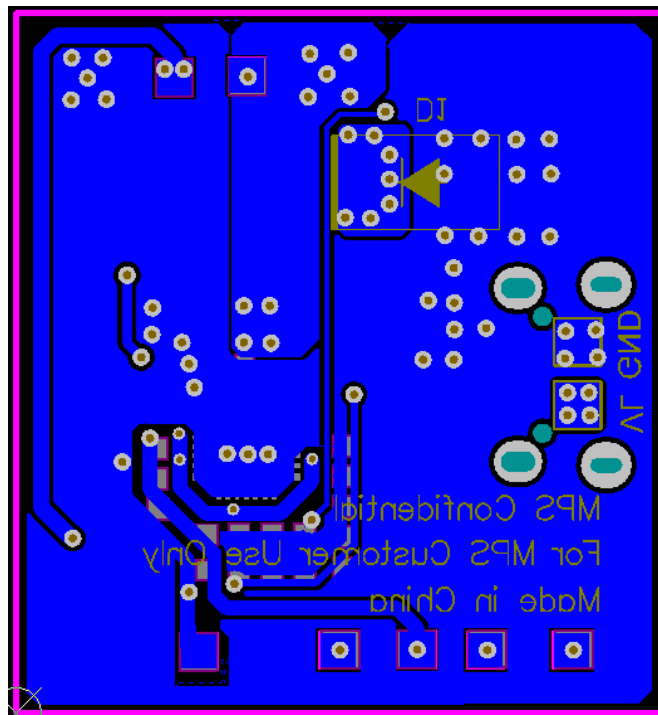

Figure 2: Bottom Layer

QUICK START GUIDE

This demo board is reference design for MP2639A, flexible switch-mode battery charging management device for 2-cell series Li-ion and Li-Polymer battery pack used in a wide range of portable applications through the boost converter from VL to VH.

The board's layout accommodates most commonly-used capacitors. The default function of this board is preset at charge mode, and the charge full voltage is preset to 8.4V for a 2-cell series Li-Ion battery.

Charge Mode Setting

1. Input Current Limit

An input current limit can be set slightly below the input source's maximum current rating. When the input current hits this limit, the charge current could decrease to keep the input current constant at the limit value to initially power the system. R_{ILIM} —the resistor connected to the ILIM pin—programs this limit. To set the input current limit at 3A, use an R_{ILIM} of 71.5k Ω .

$$I_{INLIMIT} = \frac{640k}{3 \times R_{ILIM}} \quad (1)$$

2. Charge Current

The charge current can be programmed via R_{ISET} . Determine the charge current using the following formula:

$$I_{CHG} = \frac{640k}{3 \times R_{ISET}} \quad (2)$$

For 2.5A charge current, the given R_{ISET} is 85.3k Ω .

3. Input Voltage Limit

The input voltage clamp threshold can be programmable by the VLIM pin. The internal reference of the input voltage loop is 1.2V, so the input voltage clamp limit would be,

$$V_{INLIMIT} = 1.2 \times \frac{R_3 + R_4}{R_4} \quad (3)$$

Here, $R_3=27.4k\Omega$, $R_4=10k\Omega$, the input voltage clamp value is 4.49V.

EQUIPMENT REQUIREMENT

Evaluation requires the following equipments:

1. For the charge input, USB cable with an adaptor or any USB port with load capability can be directly used for the reference design board. In case some operation state can't be tested, external wire can be added to connect a power source with 6V/3A capability.
2. Battery simulator or 2-cell battery pack. The battery simulator's output rating should exceed 9V/7.0A. When using a real battery pack, please observe all precautions on the battery manufacturer's data sheet first and ensure the charger's setting doesn't exceed the battery's absolute maximum specifications.
3. An oscilloscope. A single voltage probe and a single current probe.
4. Multi-meter.

Charge Function

- 1 Attach the positive (VH) and negative ends (PGND) of the board to the “+” and “-” terminals of battery or battery simulator, respectively. If it’s a battery simulator, please preset the voltage to 7.6V (typical value for 2-cell) first.
- 2 Attach the USB cable to USB1 port.

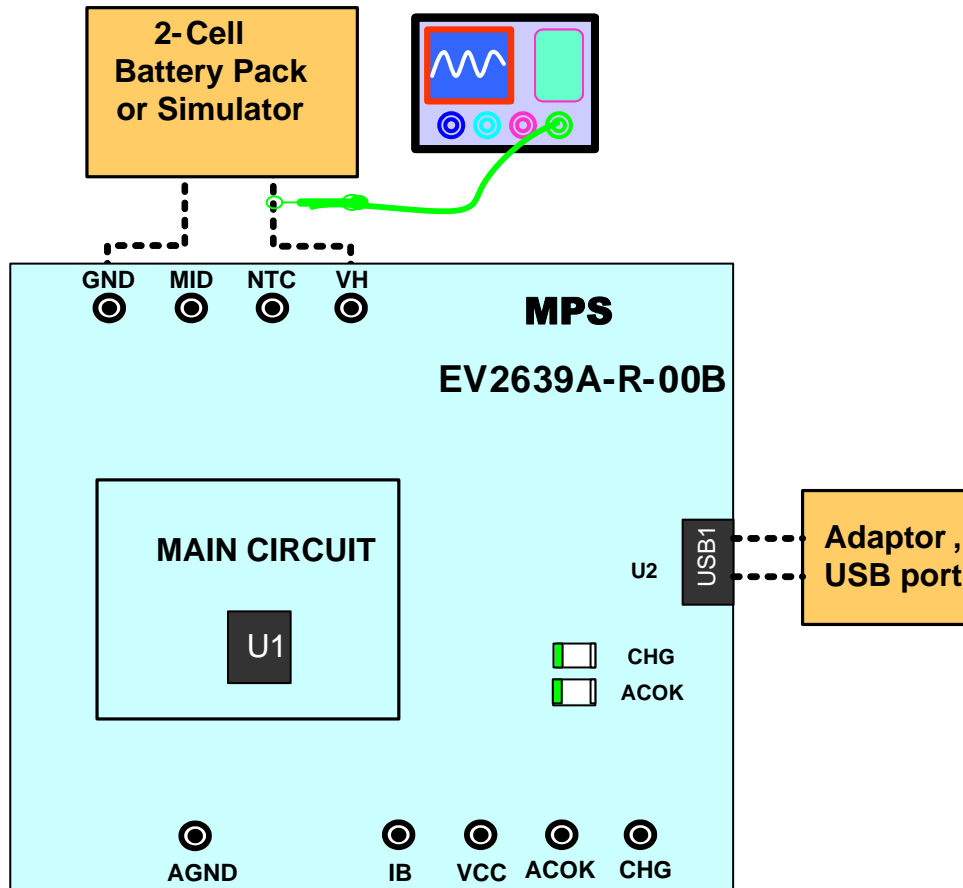

Figure 3: Setup for Charge Mode from USB cable

- 3 Insert the USB cable, the charge starts. Use the oscilloscope to verify that the charge current is being delivered to the battery. The charge current could be a different value under following conditions:
 - a. The charge current could be limited by input current limit.

The IC features the input source detection to decide the input current limit according to the input source (USB or adaptor). The IC sets the input current limit through the ILIM pin. When the input current hits this limit and battery voltage continue to increase, the charge current decreases to keep the input current constant at the limit value.

- b. The charge current could be limited by the input voltage regulation.

If the input power supply has lower current capability than the input current limit(such as USB with 500mA only) or the voltage loss on USB cable is too big, the input voltage may approach the input voltage regulation threshold (4.49V) preset by R3 and R4. Once the input voltage approaches the input voltage regulation threshold, charge current is reduced to allow priority of system power and maintain the input voltage avoid dropping further.

For the other detailed description on the operation of the MP2639A, please refer to the datasheet.

NOTICE: The information in this document is subject to change without notice. Users should warrant and guarantee that third party Intellectual Property rights are not infringed upon when integrating MPS products into any application. MPS will not assume any legal responsibility for any said applications.