



The Future of Analog IC Technology®

# EV24943DN-00A

## 3A, 55V, 100kHz Step-Down Converter with Programmable Output OVP Evaluation Board

### DESCRIPTION

The EV24943DN-00A is an evaluation board for the MP24943. The MP24943 is a monolithic step-down switch mode converter. It achieves 3A continuous output current over a wide input supply range with excellent load and line regulation. An external 4ms soft start setting prevents inrush current at turning on.

MP24943 achieves low EMI signature with well controlled switching edges.

Fault condition protection includes short circuit protection, programmable output over voltage protection and thermal shutdown.

The MP24943 requires a minimum number of readily available standard external components.

### ELECTRICAL SPECIFICATIONS

Parameter	Symbol	Value	Units
Input Voltage	$V_{IN}$	8 to 55	V
Output Voltage	$V_{OUT}$	5	V
Output OVP	$V_{OVP}$	6	V

### FEATURES

- Wide 8V to 55V Operating Input Range
- 3A Output Current
- Programmable Output Over Voltage Protection
- External 4ms Soft Start Setting
- Stable with Low ESR Output Ceramic Capacitors
- Fixed 100kHz Frequency
- Low EMI Signature
- Thermal Shutdown
- Short Circuit Protection

### APPLICATIONS

- Automotive GPS
- Car DVD
- Power Supply for Linear Chargers

For MPS green status, please visit MPS website under Quality Assurance. MPS® and "The Future of Analog IC Technology" are Registered Trademarks of Monolithic Power Systems, Inc.

### EV24943DN-00A EVALUATION BOARD



Board Number	MPS IC Number
EV24943DN-00A	MP24943

#### Efficiency vs. I<sub>OUT</sub>

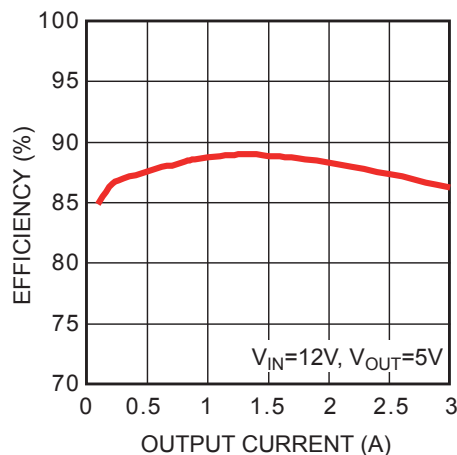

## EVALUATION BOARD SCHEMATIC

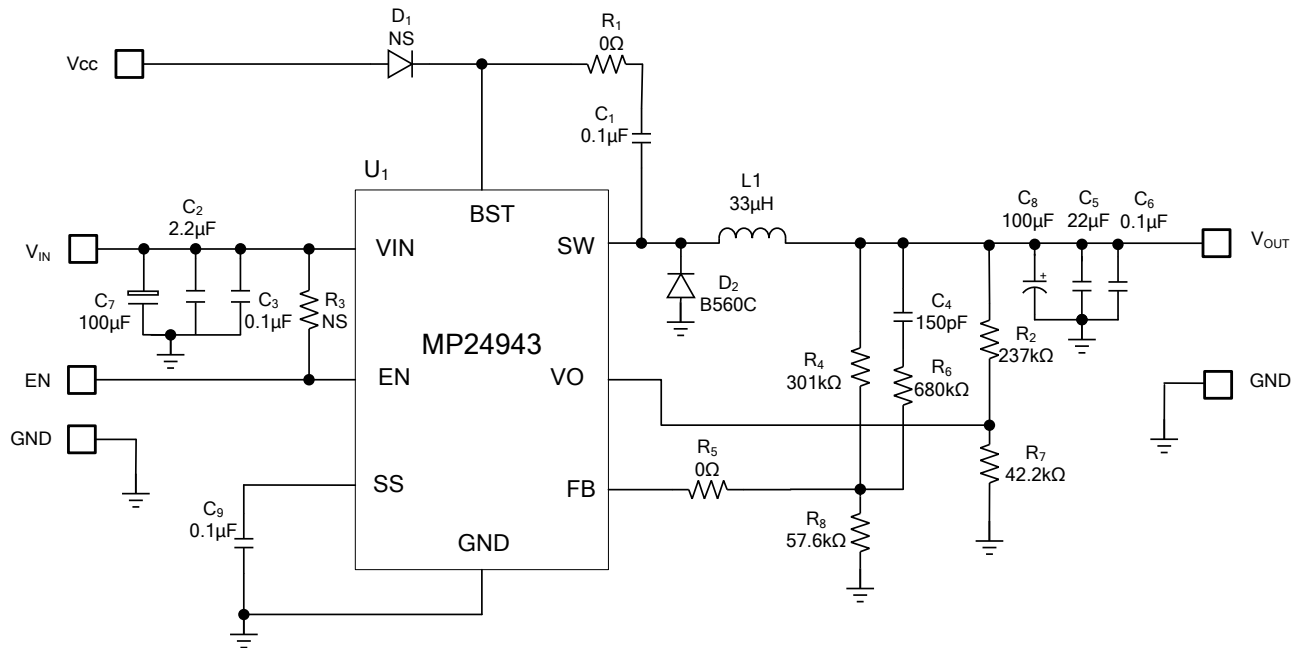

## EV24943DN-00A BILL OF MATERIALS

Qty	RefDes	Value	Description	Package	Manufacturer	Manufacturer P/N
3	C1,C6,C9	0.1µF	Ceramic Cap., 25V, X7R	0603	muRata	GRM188R71H104KA01D
1	C2	2.2µF	Ceramic Cap., 100V, X7R	1210	muRata	GRM32ER72A225KA35L
1	C3	0.1µF	Ceramic Cap., 100V, X7R	0603	muRata	GRM188R71H104KA35D
1	C4	150pF	Ceramic Cap., 50V, C0G	0603	muRata	GRM1885C1H151JA01
1	C5	22µF	Ceramic Cap., 16V, X7R	1210	muRata	GRM32ER71C226ME18L
1	C7	100µF	Electrolytic Cap., 100V	DIP	JiangHai	CD287-100V100
1	C8	100µF	Electrolytic Cap., 16V	SMD	JiangHai	VZ1-16V100
0	D1	NS	Do Not Stuff			
1	D2	B560C	Schottky Diode, 60V, 5A	SMC	Diodes	B560C
1	L1	33µH	Inductor, 5.5A/45mΩ	SMD	Würth	7447709330
2	R1, R5	0	Film Resistor, 5%	0603	Yageo	RC0603JR-070RL
1	R2	237k	Film Resistor, 1%	0603	Yageo	RC0603FR-07237KL
0	R3	NS	Do Not Stuff			
1	R4	301k	Film Resistor, 1%	0603	Yageo	RC0603FR-07301KL
1	R6	680k	Film Resistor, 1%	0603	Yageo	RC0603FR-07680KL
1	R7	42.2k	Film Resistor, 1%	0603	Yageo	RC0603FR-0742K2L
1	R8	57.6k	Film Resistor, 1%	0603	Yageo	RC0603FR-0757K6L
1	U1		DC-DC Converter	SOIC8E	MPS	MP24943DN

## EVB TEST RESULTS

Performance waveforms are tested on the evaluation board.

**C7=100μF, C2=2.2μF, C8=100μF, C5=22μF, L1=33μH, T<sub>A</sub>=25°C, unless otherwise noted.**

**Loop Gain with Phase Margin**  
 $V_{IN}=12V, V_{OUT}=5V, I_{OUT}=3A$ , Resistor Load

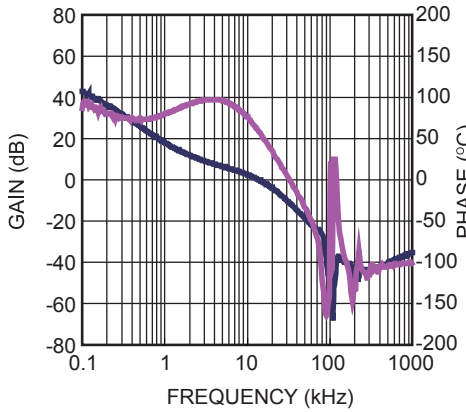

**Efficiency vs. Output Current**  
 $V_{OUT}=5V$

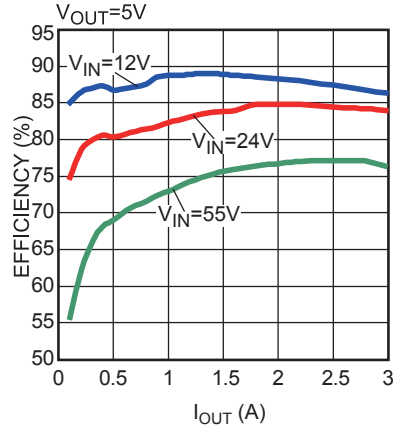

**Load Regulation**

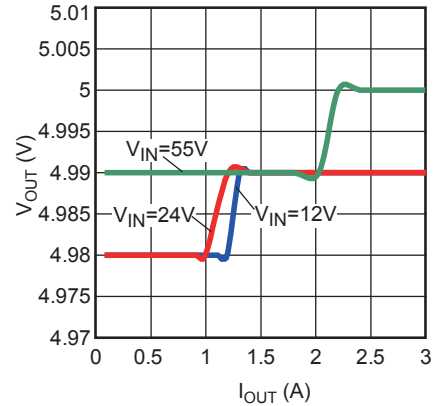

**EMI Radiation**

$V_{IN} = 12V, V_{OUT} = 5V, I_{OUT} = 3A$ , Resistor Load

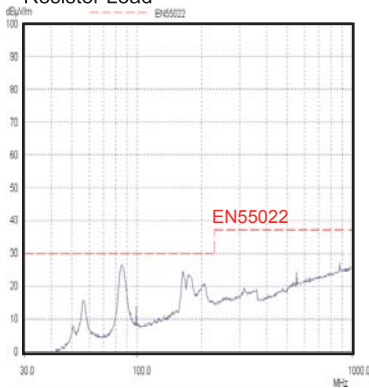

**Steady State**

$V_{IN} = 12V, V_{OUT} = 5V, I_{OUT} = 3A$ , E-Load

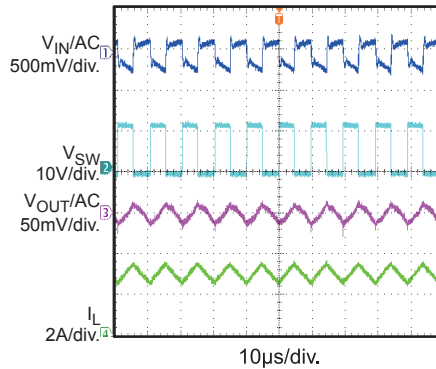

**Steady State**

$V_{IN} = 55V, V_{OUT} = 5V, I_{OUT} = 3A$ , E-Load

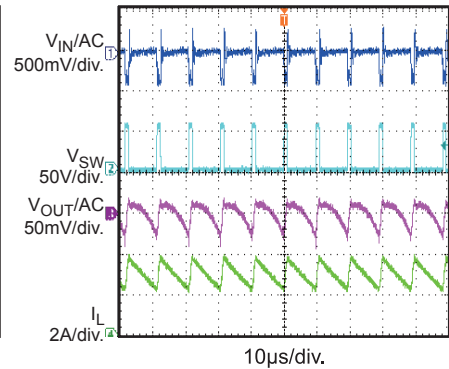

**Power Ramp Up**

$V_{IN} = 12V, V_{OUT} = 5V, I_{OUT} = 3A$ , Resistor Load

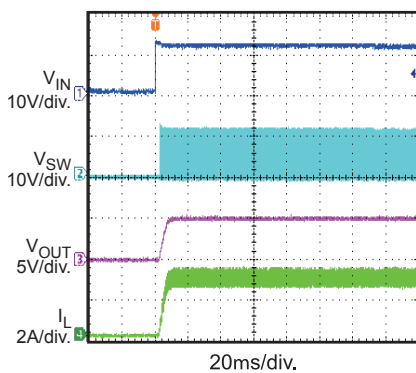

**Power Ramp Down**

$V_{IN} = 12V, V_{OUT} = 5V, I_{OUT} = 3A$ , Resistor Load

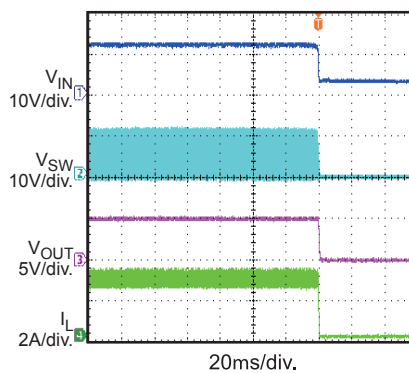

**Enable Start Up**

$V_{IN} = 12V, V_{OUT} = 5V, I_{OUT} = 3A$ , Resistor Load

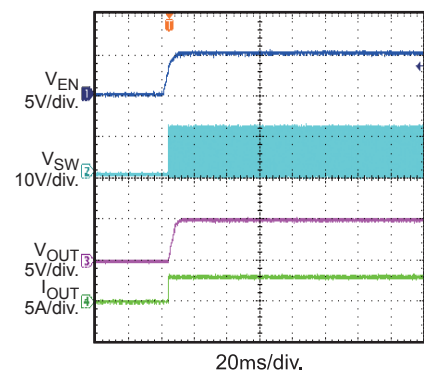

**EVB TEST RESULTS** *(continued)*

Performance waveforms are tested on the evaluation board.

C7=100µF, C2=2.2µF, C8=100µF, C5=22µF, L1=33µH, T<sub>A</sub>=25°C, unless otherwise noted.

**Enable Shutdown**

V<sub>IN</sub> = 12V, V<sub>OUT</sub> = 5V, I<sub>OUT</sub> = 3A,  
Resistor Load

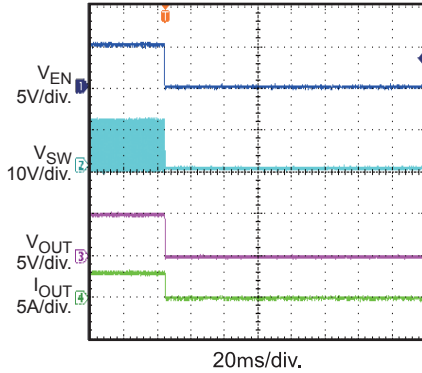

**Short Circuit Enter**

V<sub>IN</sub> = 12V, V<sub>OUT</sub> = 5V, I<sub>OUT</sub> = 0A

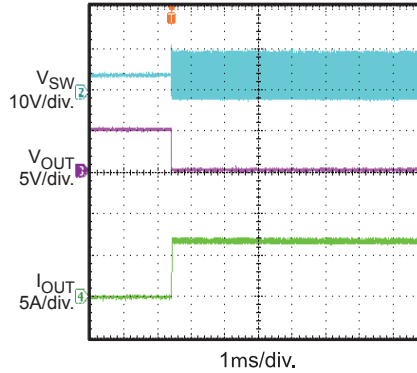

**Short Circuit Steady**

V<sub>IN</sub> = 12V, V<sub>OUT</sub> = 5V

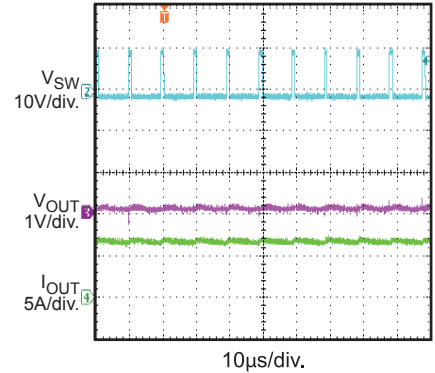

**Short Circuit Recovery**

V<sub>IN</sub> = 12V, V<sub>OUT</sub> = 5V, I<sub>OUT</sub> = 0A

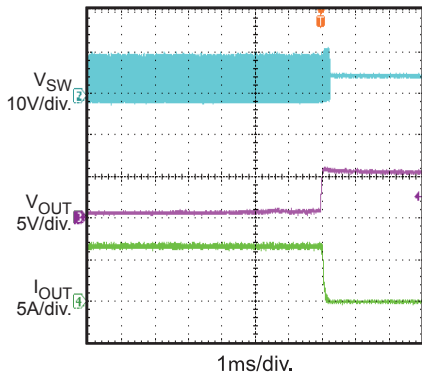

**Load Transient Response**

V<sub>IN</sub> = 12V, V<sub>OUT</sub> = 5V, I<sub>OUT</sub> = 3A,  
Slew Rate=6.4mA/µs

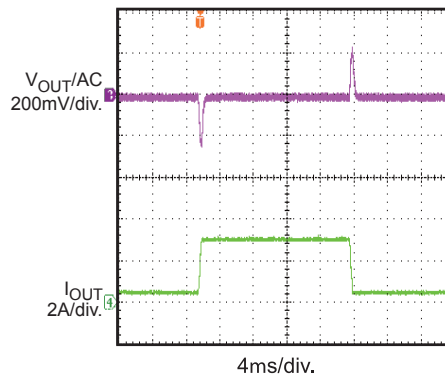

**OVP Enter**

V<sub>IN</sub> = 12V, V<sub>OUT</sub> = 5V, I<sub>OUT</sub> = 3A,  
E-Load

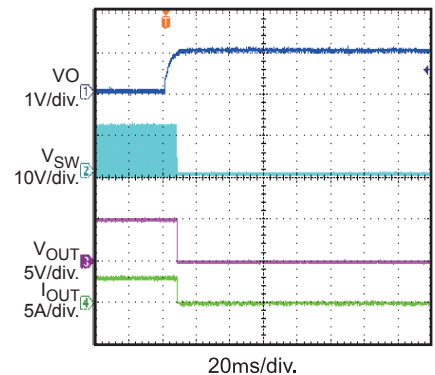

**OVP Recovery**

V<sub>IN</sub> = 12V, V<sub>OUT</sub> = 5V, I<sub>OUT</sub> = 3A,  
E-Load

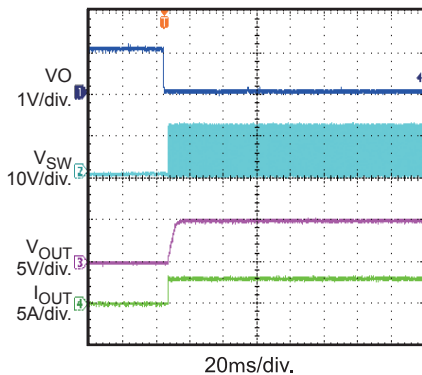

### PRINTED CIRCUIT BOARD LAYOUT

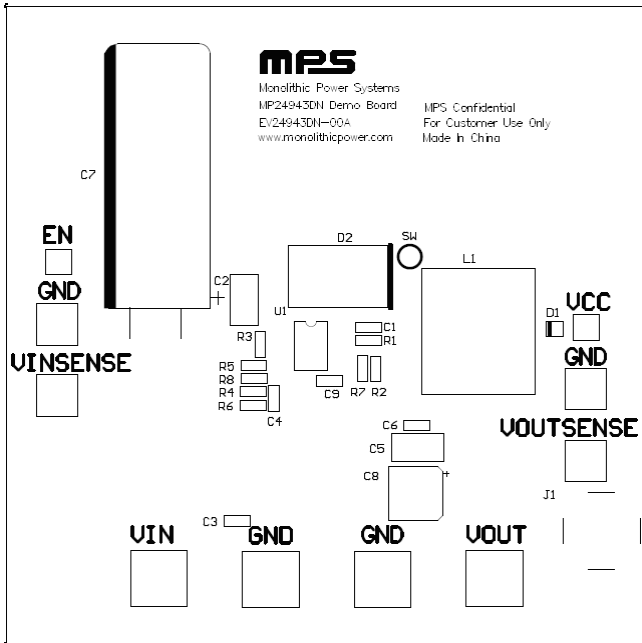

Figure 1—Top Silk Layer

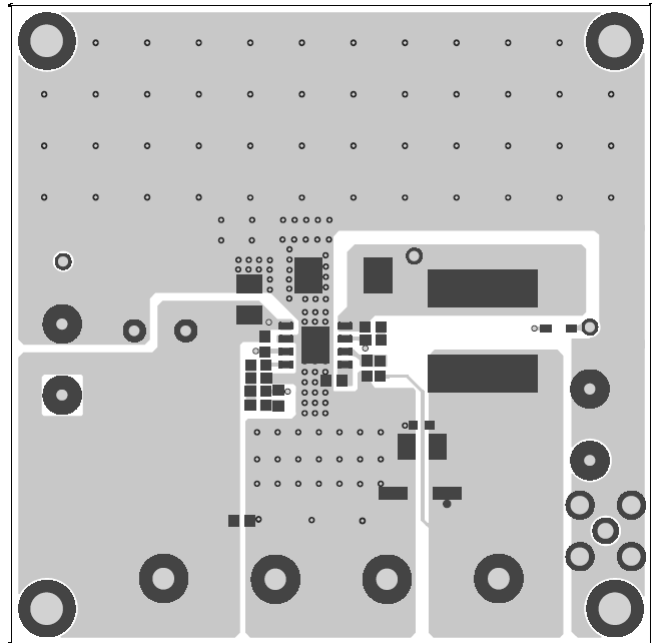

Figure 2—Top Layer

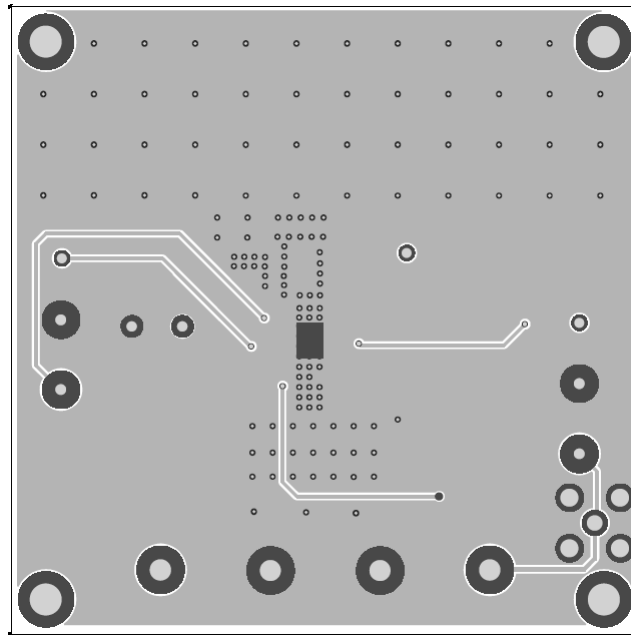

Figure 3—Bottom Layer

## QUICK START GUIDE

1. The output voltage of this board is set to 5V. The board layout accommodates most commonly used inductors and output capacitors.
2. Attach the positive and negative ends of the load to the VOUT and GND pins, respectively.
3. Attach the input voltage ( $8V \leq V_{IN} \leq 55V$ ) and input ground to the VIN and GND pins, respectively.
4. To use the Enable supply on, apply a digital input to the EN pin. Drive EN higher than 1.8V to turn on the regulator, drive EN less than 0.4V to turn it off.
5. The output voltage  $V_{OUT}$  can be set by R8. The formula is:

$$R8 = R4 \times \frac{V_{FB}}{V_{OUT} - V_{FB}}$$

Where  $V_{FB} = 0.8V$

For example, for  $V_{OUT} = 5V$ ,  $R4=301k\Omega$ :

$$R8 = R4 \times \frac{V_{FB}}{V_{OUT} - V_{FB}} = 301k\Omega \times \frac{0.8V}{5V - 0.8V} \approx 57.6k\Omega$$

For the closest standard 1% value.

6. When the VO pin voltage is higher than 0.9V, the part will shutdown until VO pin voltage drops below 0.9V. The R7 is set as:

$$R7 = R2 \times \frac{0.9V}{(V_{OVP} - 0.9V)}$$

**NOTICE:** The information in this document is subject to change without notice. Users should warrant and guarantee that third party Intellectual Property rights are not infringed upon when integrating MPS products into any application. MPS will not assume any legal responsibility for any said applications.