



The Future of Analog IC Technology®

EV2482DN-00A

5A, 30V, 420KHz Step-Down Converter With Synchronizable Gate Driver

DESCRIPTION

The EV2482DN-00A is an evaluation board for the MP2482, a high frequency step-down switch mode converter with a built in internal power MOSFET.

The MP2482 achieves 5A continuous output current over a wide input supply range with excellent load and line regulation.

Current mode operation provides fast transient response and eases loop stabilization. Fault condition protection includes cycle-by-cycle current limiting and thermal shutdown.

The MP2482 requires a minimum number of readily available standard external components and is available in an 8-pin SOIC package with exposed pad.

ELECTRICAL SPECIFICATIONS

Parameter	Symbol	Value	Units
Input Voltage	V_{IN}	4.5 – 30	V
Output Voltage	V_{OUT}	3.3	V
Output Current	I_{OUT}	5	A

FEATURES

- Wide 4.5V to 30V Operating Input Range
- 5A Output Current
- 50mΩ Internal Power MOSFET Switch
- Fixed 420KHz Frequency
- Synchronizable up to 1.4MHz
- Cycle-by-Cycle Over Current Protection
- Thermal Shutdown
- Output Adjustable from 0.8V to 15V
- Stable with Low ESR Output Ceramic Capacitors

APPLICATIONS

- Digital Set Top Boxes
- Personal Video Recorders
- Broadband Communications
- Flat Panel Television and Monitors

"MPS" and "The Future of Analog IC Technology" are Registered Trademarks of Monolithic Power Systems, Inc.

EV2482DN-00A EVALUATION BOARD



(L x W x H) 1.8" x 1.8" x 0.4"
(4.6cm x 4.6cm x 1.0cm)

Board Number	MPS IC Number
EV2482DN-00A	MP2482DN

Efficiency vs Output Current

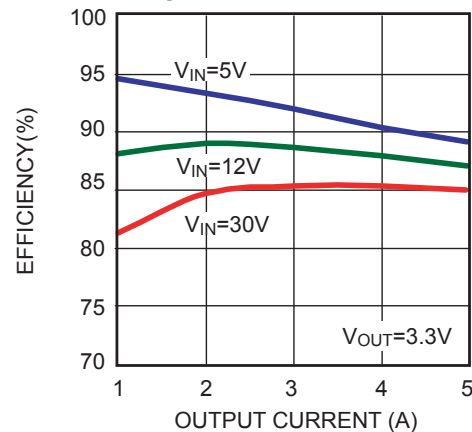

EVALUATION BOARD SCHEMATIC

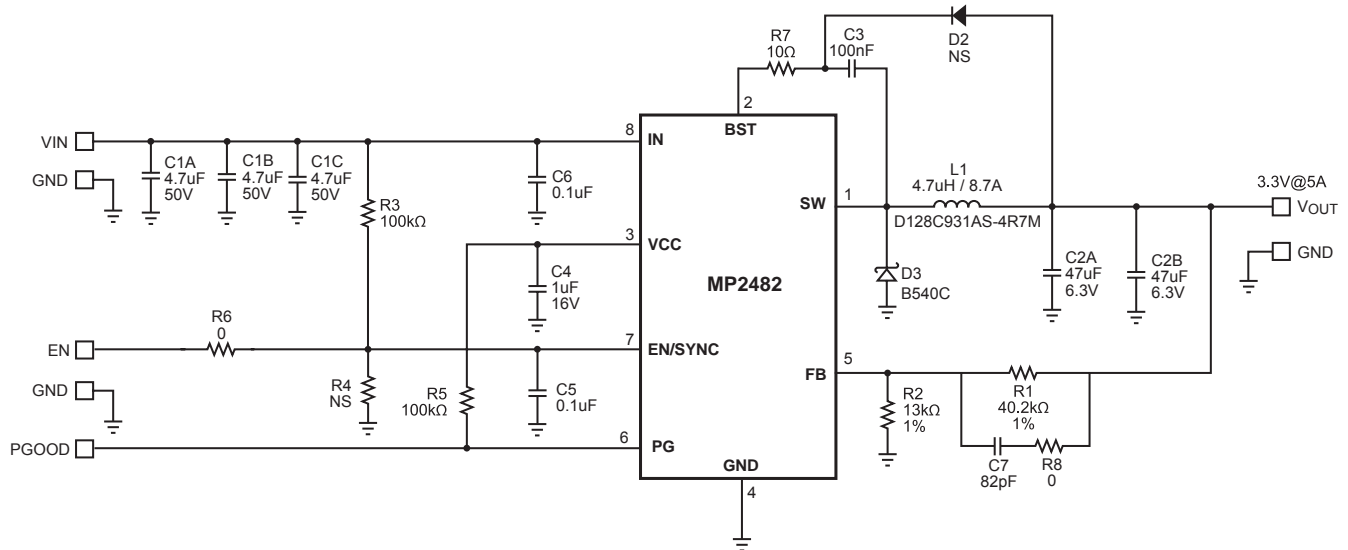

EV2482DN-00A BILL OF MATERIALS

Qty	Ref	Value	Description	Package	Manufacturer	Part Number
3	C1A, C1B, C1C	4.7µF	Ceramic Cap., 50V, X7R	1210	Murata	GRM32ER71H475KA88L
2	C2A, C2B	47µF	Ceramic Cap., 10V, X5R	1210	Murata	GRM32ER61A476KE20L
3	C3, C5, C6	0.1µF	Ceramic Cap., 50V X7R	0603	Murata	GRM188R71H104KA93D
1	C4	1µF	Ceramic Cap, 10V, X5R	0603	Murata	GRM185R61A105KE36
1	C7	82pF	Ceramic Cap., 50V X7R	0603	Any	
1	C8	22µF	Ceramic Cap., 6.3V, X5R	1210	TDK	C3225X5R0J226M
1	R1	40.2kΩ	Film Res., 1%	0603	Yageo	RC0603FR-0740k2L
1	R2	13kΩ	Film Res., 1%	0603	Yageo	RC0603FR-0713kL
1	R3	100kΩ	Film Res., 5%	0603	Any	
1	R4	NS	Not Stuffed			
1	R5	100kΩ	Film Res., 5%	0603	Any	
2	R6, R8	0	Film Res., 5%	0603	Any	
1	R7	10Ω	Film Res., 5%	0603	Any	
1	D1		Diode 40V 5A	SMC	DIODE	B540C
1	D2	NS	Not Stuffed			
1	L1	4.7µH	Inductor, 8.7A	SMD	Toko	D128C931AS-4R7M
1	U1		Step-Down Regulator	SO8	MPS	MP2482DN

PRINTED CIRCUIT BOARD LAYOUT

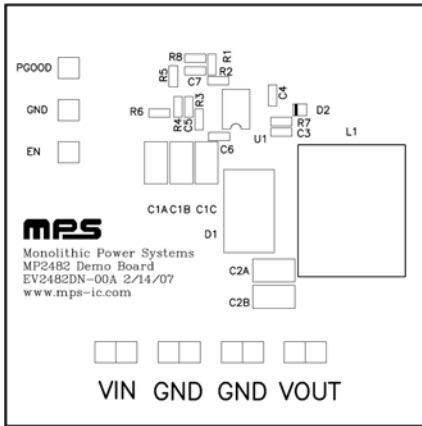

Figure 1—Top Silk Layer

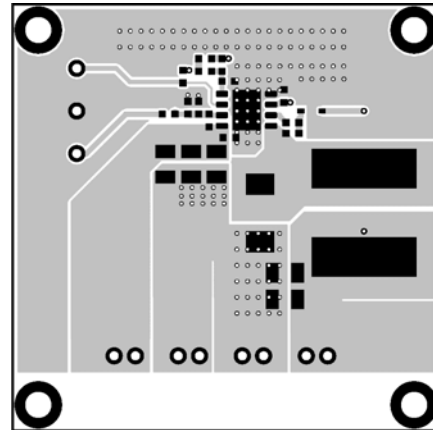

Figure 2—Top Layer

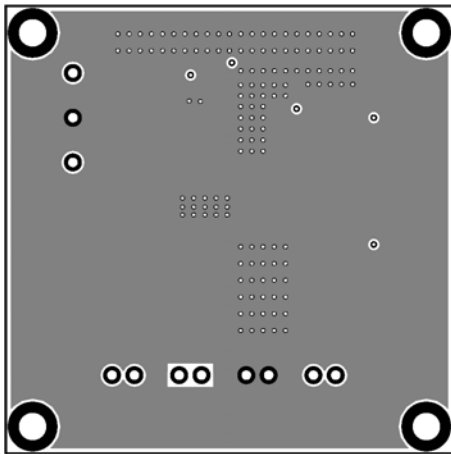

Figure 3—Inner Layer 1

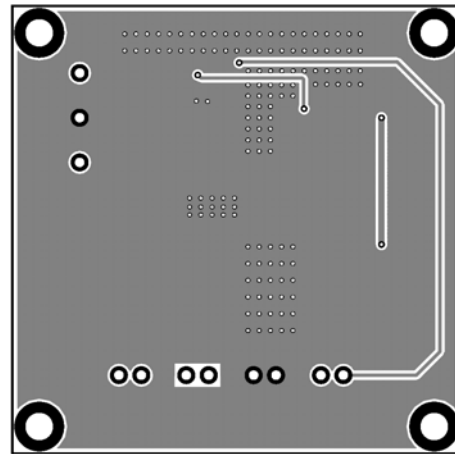

Figure 4—Inner Layer 2

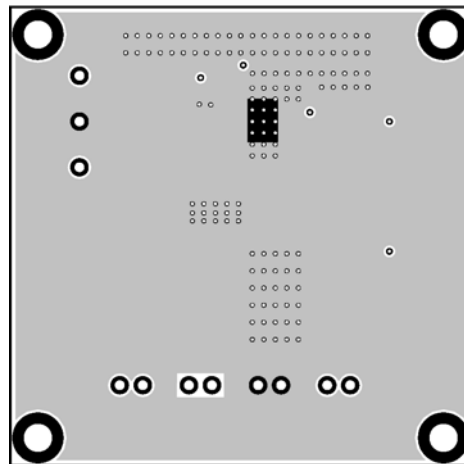

Figure 5—Bottom Layer

QUICK START GUIDE

1. Connect the positive and negative terminals of the load to VOUT and GND pins, respectively.
2. Preset the power supply output to 4.5V – 30V and turn off the power supply.
3. Connect the positive and negative terminals of the power supply output to the VIN and GND pins, respectively.
4. Turn the power supply on. The board will automatically startup.
5. To use the Enable function, apply a digital input to EN pin. Drive EN higher than 1.2V to turn on the regulator, drive EN less than 0.4V to turn it off.
6. Apply up to 1.4MHz frequency logic level clock signal to the EN pin to synchronize the device to an external clock. The duty cycle is not critical.

NOTICE: The information in this document is subject to change without notice. Users should warrant and guarantee that third party Intellectual Property rights are not infringed upon when integrating MPS products into any application. MPS will not assume any legal responsibility for any said applications.