

DESCRIPTION

The EV2480-N-00A Evaluation Board is designed to demonstrate the capabilities of MP2480DN. The MP2480 is step-down switching regulator to deliver a constant current of up to 3A for high power LED

With a 30-36V input VIN and a EN DC signal which is higher than 2V, EV2480-N-00A can deliver a regulated voltage to drive a LED string. The LED current is regulated to about 2A.

ELECTRICAL SPECIFICATION

Parameter	Symbol	Value	Units
Input Voltage	VIN	30-36	V
Enable	EN	2- 5	V
Dimming	DIM	2- 5	V
LED Current	I _{LED}	2	A
LED Voltage	V _{LED}	24	V

FEATURES

- Wide 5V to 36V Operating Input Range
- Up to 95% Efficiency
- Hysteretic Control with No Compensation
- No Output Capacitor Required
- ±3% LED Current Accuracy
- Up to 2MHz Switching Frequency
- Up to 20kHz Dimming Frequency
- 200mV Reference Voltage
- Short-Circuit Protection with Integrated High-Side MOSFET
- Thermal Shut Down

AVAILABLE IN SOIC8-EPAPPLICATIONS

- High Power LED Driver
- General Lighting and LCD Backlighting
- Constant Current Source

For MPS green status, please visit MPS website under Quality Assurance. "MPS" and "The Future of Analog IC Technology", are Registered Trademarks of Monolithic Power Systems, Inc.

EV2480-N-00A EVALUATION BOARD



(L x W x H) 6.35cm x 6.35cm x 0.8cm

Board Number	MPS IC Number
EV2480-N-00A	MP2480DN

Efficiency vs. LED Number

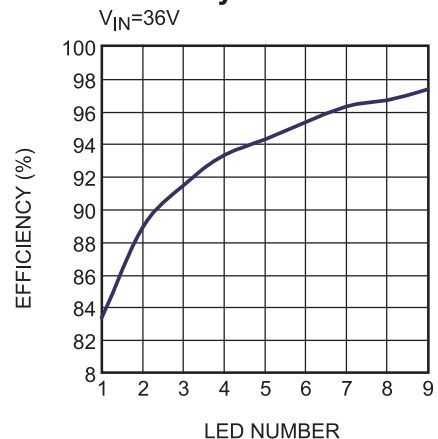

EVALUATION BOARD SCHEMATIC

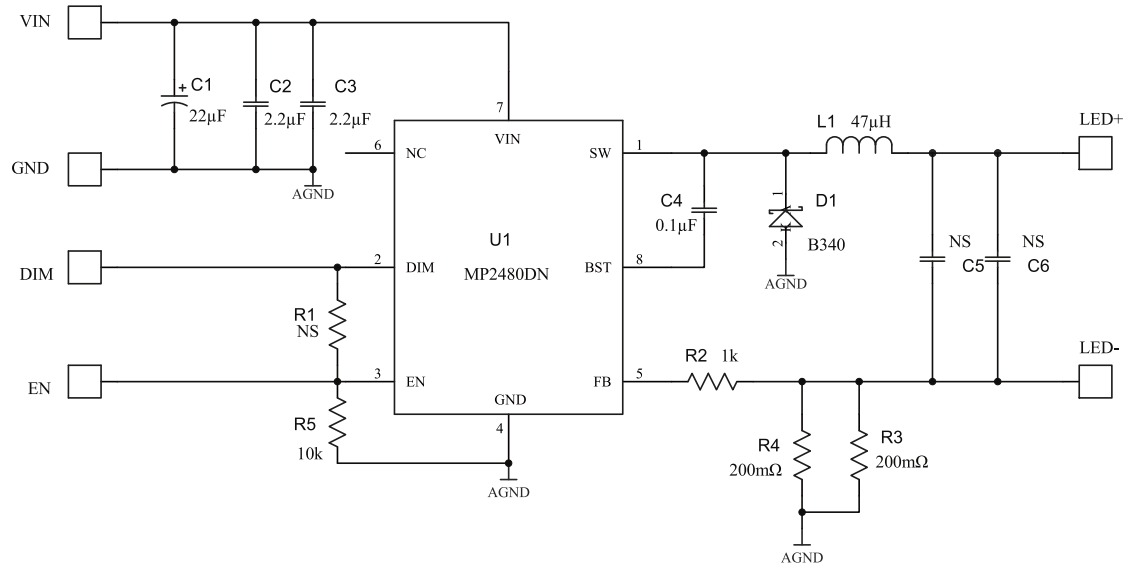

EV2480-N-00A BILL OF MATERIALS

Qty	Ref	Value	Description	Package	Manufacturer	Part Number
1	C1	22µF	Electrolytic Capacitor,50V	DIP		22µF./50V
2	C2,C3	2.2µF	Ceramic Capacitor,50V,X7R	1206	muRata	GRM32ER71H225 KA88L
1	C4	0.1µF	Ceramic Cap., 50V, 10%, X7R	0603	muRata	GRM188R71H104K
2	C5,C6	NC		1206		
1	D1	B340	Diode Schottky	SMC	Diodes Inc.	B340
1	L1	47µH	Inductor 2.7A	SMD	Wurth	744770147
1	R1	NC		0603		
1	R2	1k	Film Res., 1%	0603	Yageo	RC0603FR-071KL
2	R3,R4	200mΩ	Film Res., 1%	1206	Yageo	RL1206FR-070R2L
1	R5	10k	Film Res., 1%	0603	Yageo	RC0603FR-0710KL
1	U1	MP2480DN	MPS WLED Driver	SOIC8-EP	MPS	MP2480DN

EVB TEST RESULTS

Performance waveforms are tested on the evaluation board.

V_{IN} = 30V, I_{LED} = 2A, 7 LEDs Load, T_A = 25°C, unless otherwise noted.

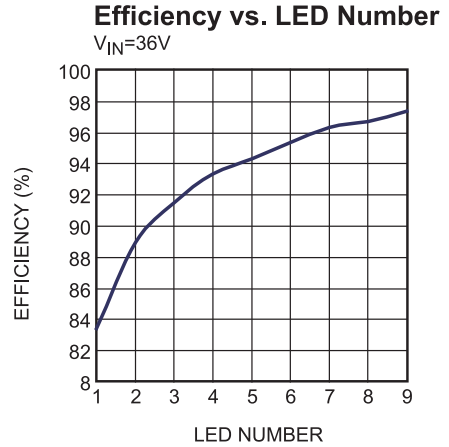
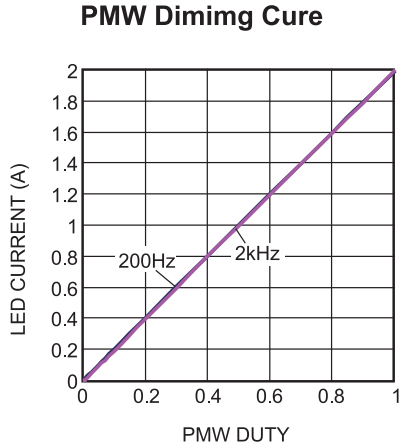

Steady State

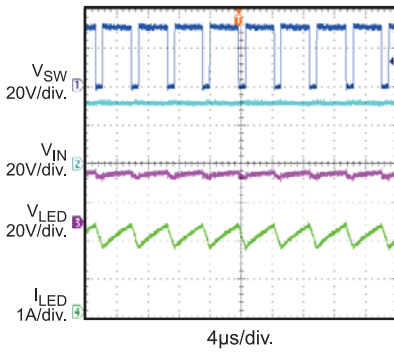

V_{IN} Startup

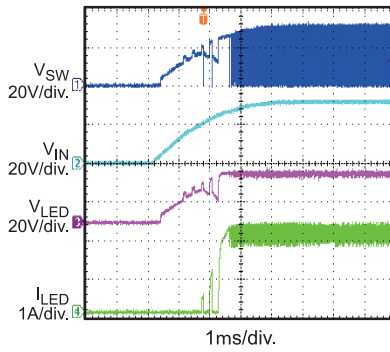

V_{IN} Off

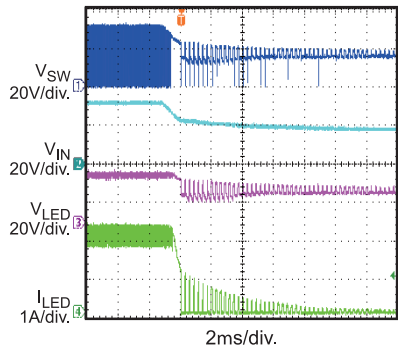

EN Startup

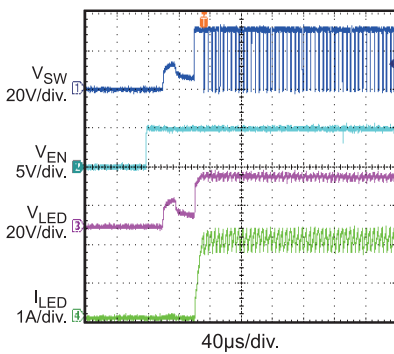

EN Off

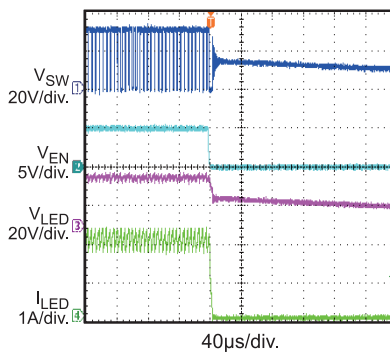

PWM Dimming

f_{PWM} = 2kHz, D_{PWM} = 50%

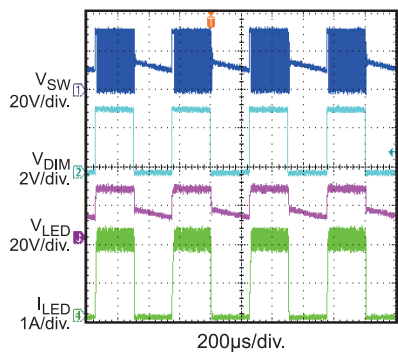

EVB TEST RESULTS (continued)

Performance waveforms are tested on the evaluation board.

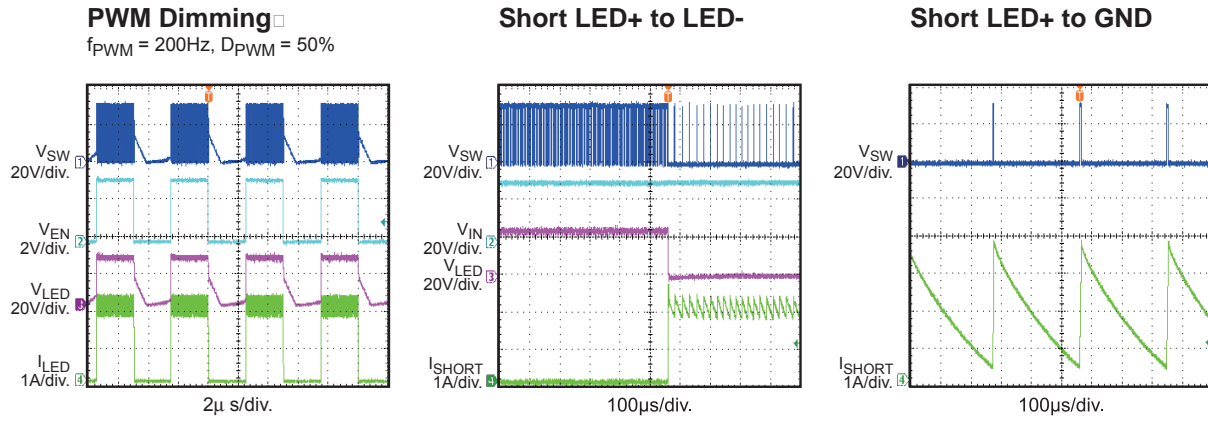
VIN = 30V, ILED = 2A, 7 LEDs Load, TA = 25°C, unless otherwise noted.

PRINTED CIRCUIT BOARD LAYOUT

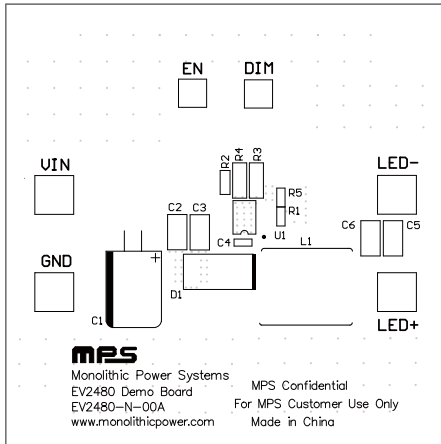

Figure 1—Top Silk Layer

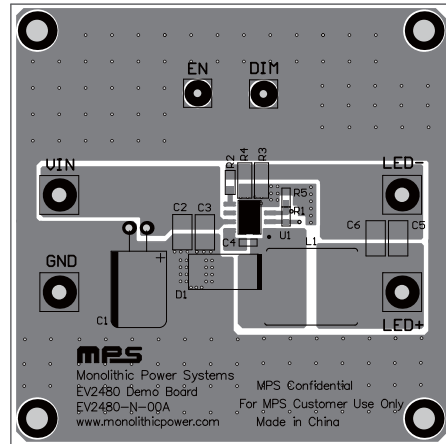

Figure 2—Top Layer

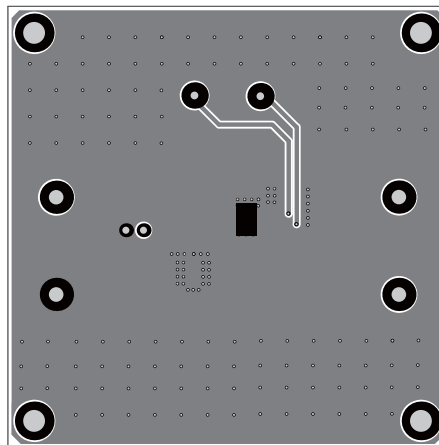

Figure 3—Bottom Layer

QUICK START GUIDE

1. Check the LED string voltage and preset the input voltage power supply to 30-36V.
2. Set a second power supply to 2- 5V as the power supply for 'EN'.
3. Turn-off all power supplies. Connect all the power supply.
4. Connect the anode of the LED string to LED+, and the cathode to LED-.
5. Turn on the power supplies. The LED string should be lighten
6. To demo the dimming function: Connect the 'DIM' with a function generator. Set the PWM signal amplitude to 2- 5V and the frequency within 100Hz to 20kHz range.

NOTICE: The information in this document is subject to change without notice. Please contact MPS for current specifications. Users should warrant and guarantee that third party Intellectual Property rights are not infringed upon when integrating MPS products into any application. MPS will not assume any legal responsibility for any said applications.