

### DESCRIPTION

The EV2324-J-00A demonstrates MPS's MP2324, a high-frequency, synchronous, rectified, step-down converter with built-in high-side and low-side power MOSFETs. The MP2324 offers a very compact solution to achieve a 2A continuous output current with excellent load and line regulation over a wide input supply range. The MP2324 has synchronous mode operation for higher efficiency over the output current load range.

Current-mode operation provides fast transient response and eases loop stabilization.

Full protection features includes over-current protection and thermal shutdown.

The MP2324 is available in a space-saving 8-pin TSOT23 package.

### ELECTRICAL SPECIFICATION

Parameter	Symbol	Value	Units
Input Voltage	$V_{IN}$	4.5 – 24	V
Output Voltage	$V_{OUT}$	3.3	V
Output Current	$I_{OUT}$	2	A

### FEATURES

- Wide 4.5V to 24V Operating Input Range
- 120mΩ/50mΩ Low  $R_{ds(on)}$  Internal Power MOSFETs
- Low Quiescent Current
- High Efficiency Synchronous Mode Operation
- Fixed 500kHz Switching Frequency
- Frequency Sync from 200kHz to 2MHz External Clock
- Power Save Mode at light load
- Internal Soft Start
- Power Good Indicator
- OCP Protection and Hiccup
- Thermal Shutdown
- Output Adjustable from 0.8V
- Available in an 8-pin TSOT-23 package

### APPLICATIONS

- Notebook Systems and I/O Power
- Digital Set Top Boxes
- Flat Panel Television and Monitors

All MPS parts are lead-free and adhere to the RoHS directive. For MPS green status, please visit MPS website under Quality Assurance. "MPS" and "The Future of Analog IC Technology", are Registered Trademarks of Monolithic Power Systems, Inc.

## EV2324-J-00A EVALUATION BOARD



Board Number	MPS IC Number
EV2324-J-00A	MP2324GJ

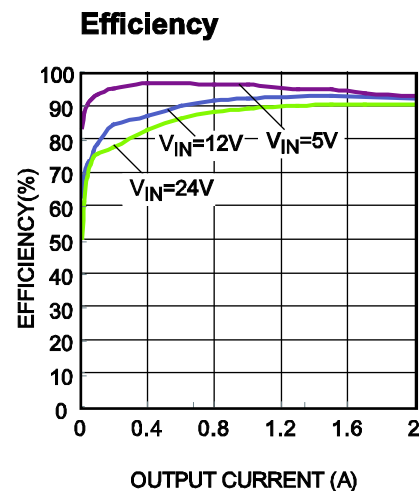

## EVALUATION BOARD SCHEMATIC

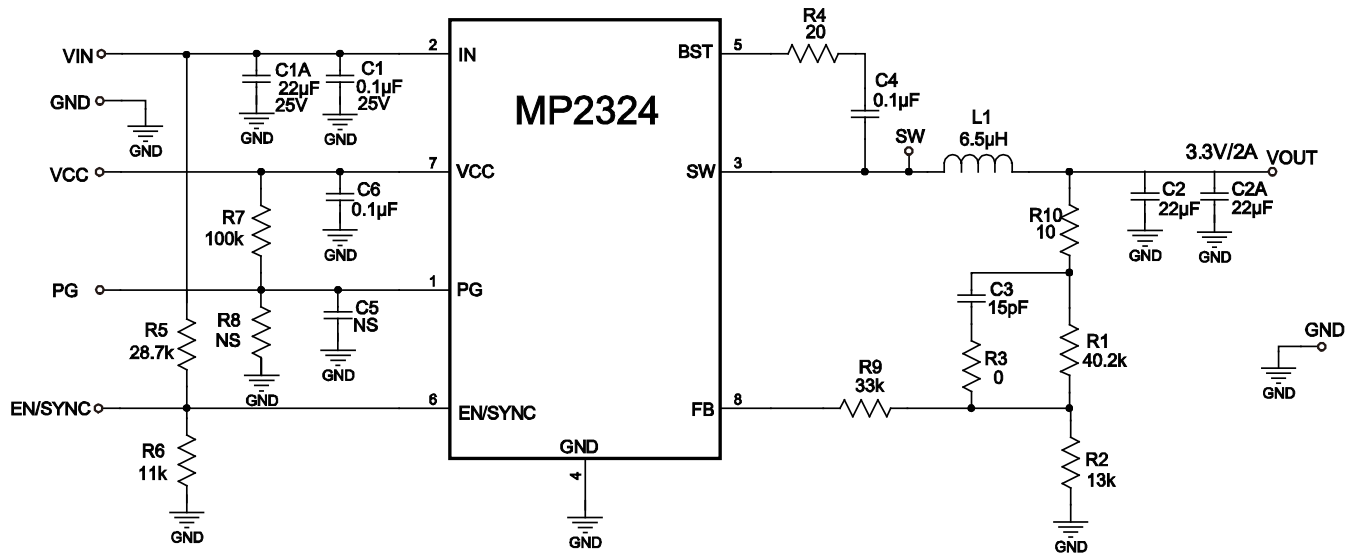

## EV2324-J-00A BILL OF MATERIALS

Qty	RefDes	Value	Description	Package	Manufacturer	Manufacturer P/N
1	C1	0.1μF	Ceramic Cap., 25V, X7R	0805	muRata	GRM21BR71E104KA01L
1	C1A	22μF	Ceramic Cap., 25V, X5R	1206	muRata	GRM31CR61E226KE15L
0	C7,R8, C5	NS				
2	C2,C2A	22μF	Ceramic Cap., 10V, X7R	1206	muRata	GRM21BR60J226ME39L
1	C3	15pF	Ceramic Cap., 50V, C0G	0603	muRata	GRM1885C1H150JA01D
2	C4,C6	0.1μF	Ceramic Cap., 16V, X7R	0603	muRata	GRM188R71C104KA01D
1	R1	40.2k	Thick Film Res., 1%	0603	Yageo	9C06031A4022FKHFT
1	R2	13k	Thick Film Res., 1%	0603	Yageo	9C06031A132FKHFT
1	R3	0Ω	Thick Film Res., 1%	0603	Yageo	9C06031A0R00JLHFT
1	R4	20Ω	Thick Film Res., 5%	0603	Yageo	9C06031A20R0JLHFT
1	R5	28.7k	Thick Film Res., 1%	0603	Yageo	9C06031A2872FKHFT
1	R6	11k	Thick Film Res., 1%	0603	Yageo	9C06031A1102FKHFT
1	R7	100k	Thick Film Res., 1%	0603	Yageo	9C06031A1003FKHFT
1	R9	33k	Thick Film Res., 1%	0603	Yageo	9C06031A3302FKHFT
1	R10	10Ω	Thick Film Res., 1%	0603	Yageo	9C06031A20R0FKHFT
1	L1	6.5μH	Inductor, DCR=21.5mΩ, Is=6A	SMD	Würth	744314650
1	U1	MP2324	Synchronous Step-Down Convert	TSOT23- 8	MPS	MP2324GJ

## EVB TEST RESULTS

Performance waveforms are tested on the evaluation board.

$V_{IN} = 12V$ ,  $V_{OUT} = 3.3V$ ,  $T_A = 25^\circ C$ , unless otherwise noted.

**Input/Output Ripple**

$I_{OUT} = 0A$

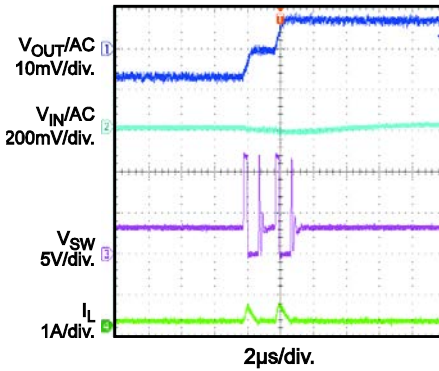

**Input/Output Ripple**

$I_{OUT} = 2A$

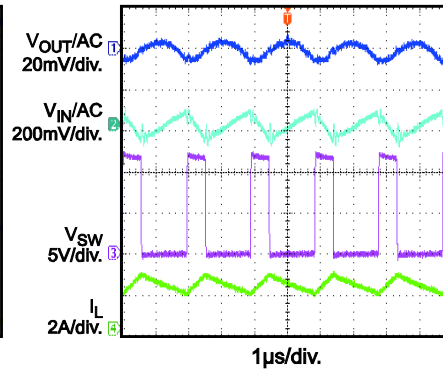

**$V_{IN}$  Start up**

$I_{OUT} = 0A$

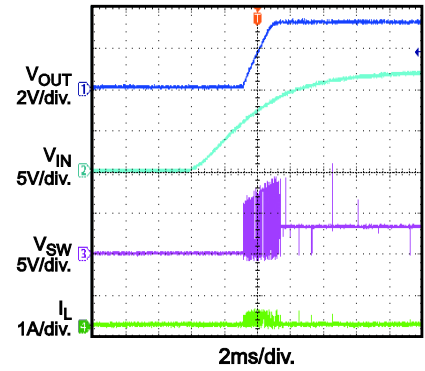

**$V_{IN}$  Start up**

$I_{OUT} = 2A$

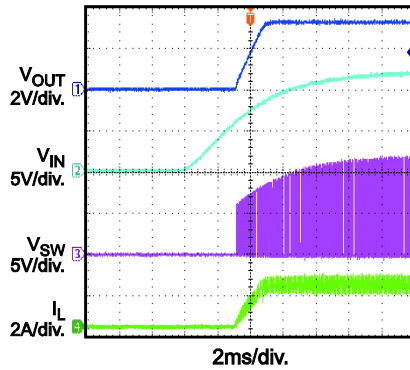

**$V_{IN}$  Shutdown**

$I_{OUT} = 0A$

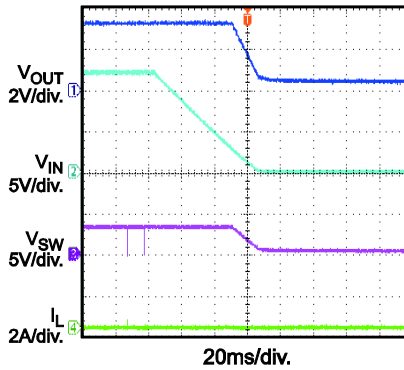

**$V_{IN}$  Shutdown**

$I_{OUT} = 2A$

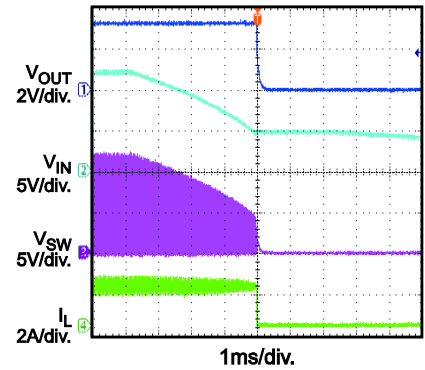

**EN Start up**

$I_{OUT} = 0A$

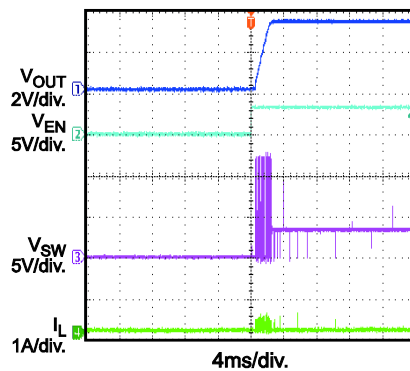

**EN Start up**

$I_{OUT} = 2A$

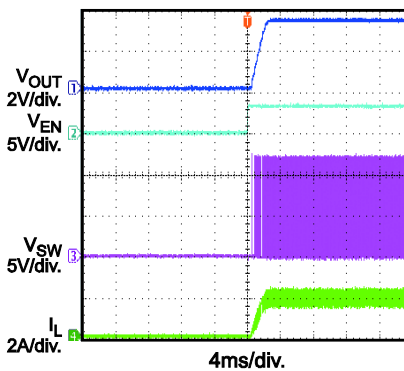

**EN Shutdown**

$I_{OUT} = 0A$

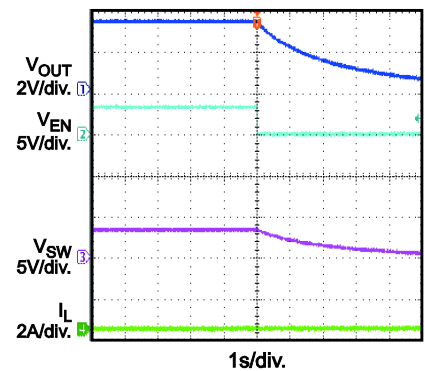

## EVB TEST RESULTS *(continued)*

Performance waveforms are tested on the evaluation board.

$V_{IN} = 12V$ ,  $V_{OUT} = 3.3V$ ,  $T_A = 25^\circ C$ , unless otherwise noted.

### EN Shutdown

$I_{OUT} = 2A$

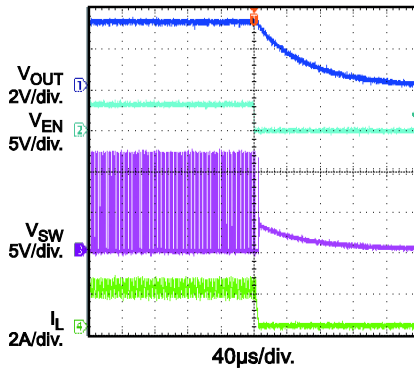

### Short Circuit Entry

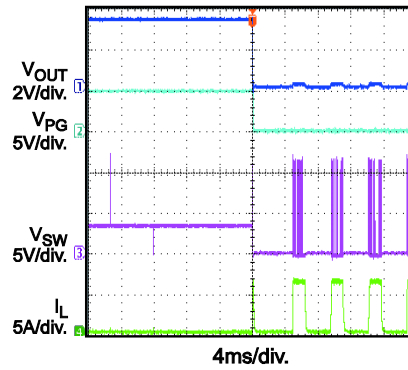

### Short Circuit

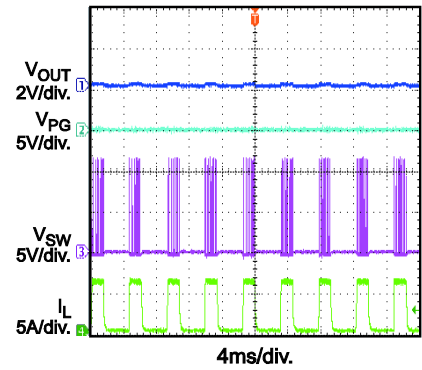

### Short Circuit Recovery

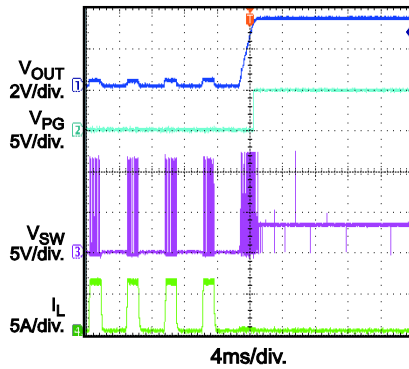

### EN Start up (PG)

$I_{OUT} = 0A$

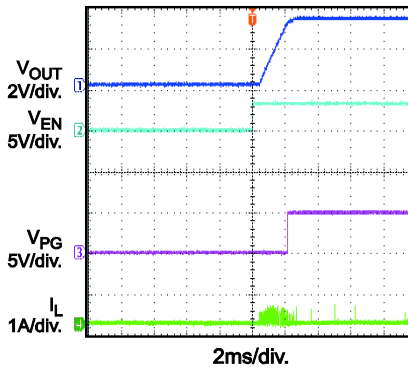

### EN Start up (PG)

$I_{OUT} = 2A$

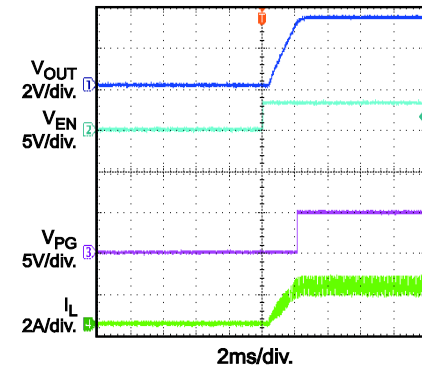

### EN Shutdown (PG)

$I_{OUT} = 0A$

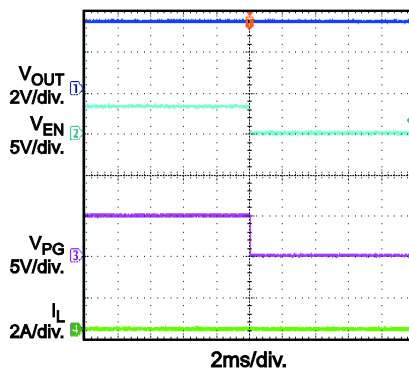

### EN Shutdown (PG)

$I_{OUT} = 2A$

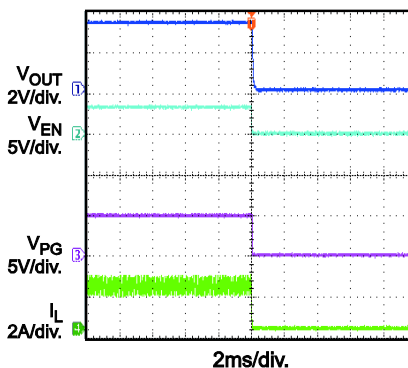

### Load Transient Response

$I_{OUT} = 1A$  to  $2A$

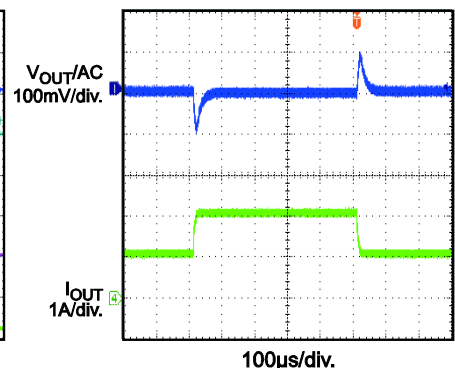

## PRINTED CIRCUIT BOARD LAYOUT

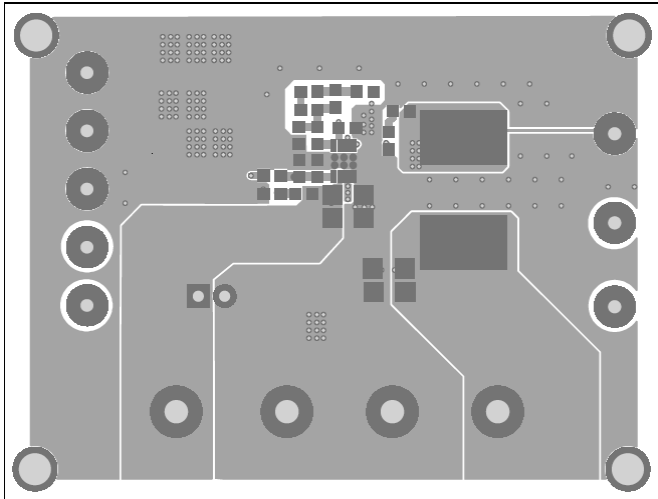

Figure 1—Top Layer

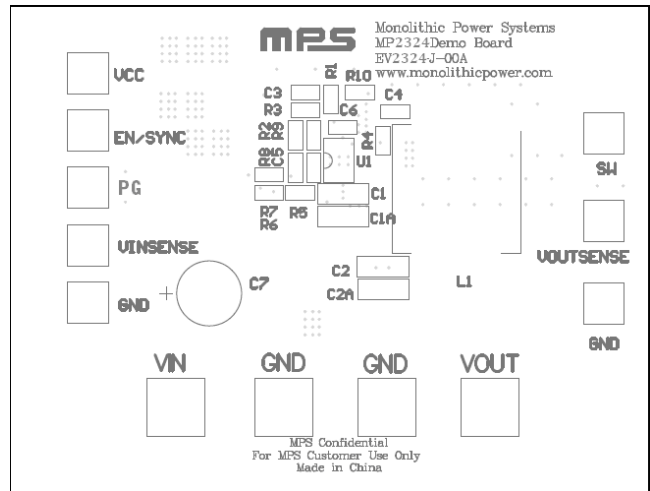

Figure 2—Top Silk Layer

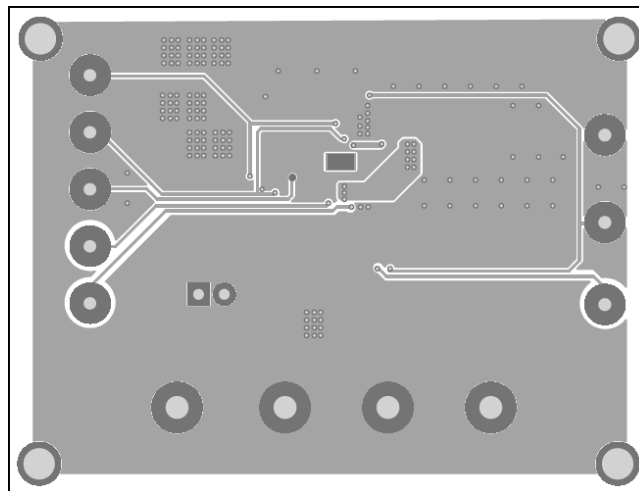

Figure 3—Bottom Layer

## QUICK START GUIDE

1. Connect the positive and negative terminals of the load to the VOUT and GND pins, respectively.
2. Preset the power supply output between 4.5V and 24V, and then turn off the power supply.
3. Connect the positive and negative terminals of the power supply output to the VIN and GND pins, respectively.
4. Turn the power supply on. The board will automatically start up.
5. To use the Enable function, apply a digital input to the EN/SYNC pin. Drive EN higher than 1.4V to turn on the regulator, or less than 1.25V to turn it off.
6. To use the external synchronous function to adjust the switching frequency, apply an external clock signal to EN/SYNC pin.

**NOTICE:** The information in this document is subject to change without notice. Please contact MPS for current specifications. Users should warrant and guarantee that third party Intellectual Property rights are not infringed upon when integrating MPS products into any application. MPS will not assume any legal responsibility for any said applications.