

DESCRIPTION

The EV2188-QA-00A evaluation Board is designed to demonstrate the capabilities of MP2188, an internally compensated 1.2MHz dual COT synchronous step-down regulator. The output voltages of the two channels are 1.1V and 1.8V respectively.

The constant-on-time control scheme provides fast transient response and eases loop stabilization. Fault condition protections include cycle-by-cycle current limiting and thermal shutdown.

The MP2188 is available in small 2.2mmx2.6mm QFN16 package and requires only a minimal number of readily available standard external components.

ELECTRICAL SPECIFICATION

Parameter	Symbol	Value	Units
Input Voltage Range	V_{IN}	3.6-5.5	V
Output Voltages	V_{OUT1}	1.1	V
	V_{OUT2}	1.8	V
Load Current	I_{OUT1}	3	A
	I_{OUT2}	3	A

Note: Low Vin application may need more input capacitors.

FEATURES

- 2.5V to 5.5V Input Voltage Range
- Fixed Output Voltages: 1.1V, 1.8V
- 100% Duty Cycle in Dropout
- Up to 3A Output Current
- Low IQ: 80 μ A
- 60m Ω and 30m Ω Internal Power MOSFET Switches
- Default 1.2MHz Switching Frequency
- EN and Power-Good for Power Sequencing
- Cycle-by-Cycle Over-Current Protection
- Auto Discharge at Power-Off
- Short-Circuit Protect with Hiccup Mode
- Stable with Low-ESR Output Ceramic Capacitors
- Available in a 2.2mm x 2.6mm QFN16 Package

APPLICATIONS

- Solid State Drives(SSD)
- Low Voltage I/O System Power
- Handheld/Battery-powered Systems
- Wireless/Networking Cards

All MPS parts are lead-free and adhere to the RoHS directive. For MPS green status, please visit MPS website under Quality Assurance. "MPS" and "The Future of Analog IC Technology", are Registered Trademarks of Monolithic Power Systems, Inc.

EV2188-QA-00A EVALUATION BOARD



Board Number	MPS IC Number
EV2188-QA-00A	MP2188GQA

Efficiency vs. I_{OUT}

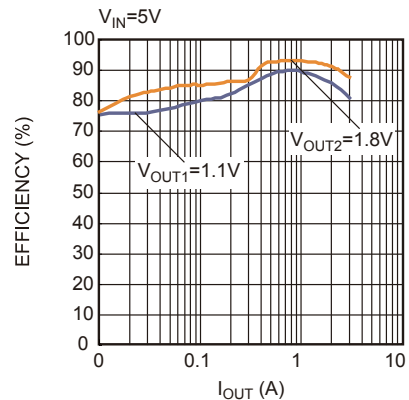

EVALUATION BOARD SCHEMATIC

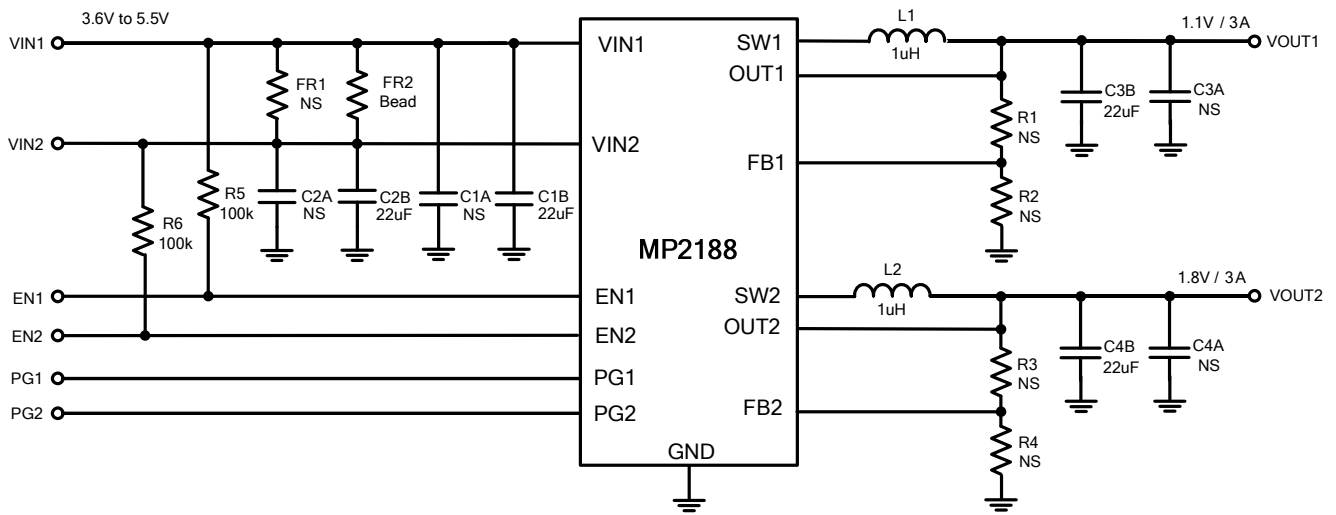

EV2188-QA-00A BILL OF MATERIALS

Qty	Ref	Value	Description	Package	Manufacturer	Manufacturer P/N
2	C1B, C2B	22 μ F	Ceramic Cap., 10V, X5R	1206	muRata	GRM31CR61A226ME19L
2	C3B, C4B	22 μ F	Ceramic Cap, 6.3V,X5R	1206	muRata	GRM31CR60J226KE19L
0	C1A, C2A, C3A, C4A, FR1	NS	NS	NS	NS	NS
1	FR2	Bead	390m Ω @100MHz, Ir=2A	1206	muRata	BLM31PG601SN1L
0	R1, R2, R3, R4	NS	NS	NS	NS	NS
2	R5, R6	100k	Film Res.,5%	0603	ROYAL	RL0603FR-07100KL
2	L1, L2	1 μ H	Inductor Isat=10.2A		Wurth	744777001
1	U1	MP2188	Step Down Switcher	QFN	MPS	MP2188

EVB TEST RESULTS

Performance waveforms are tested on the evaluation board.

$V_{IN} = 5V$, $V_{OUT1} = 1.1V$, $V_{OUT2} = 1.8V$, $L1=L2 = 1\mu H$, $C_{OUT1}=C_{OUT2}=22\mu F$, $T_A = 25^\circ C$, unless otherwise noted.

Efficiency vs. I_{OUT}

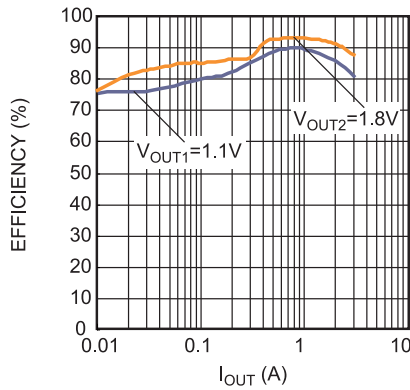

Load Regulation

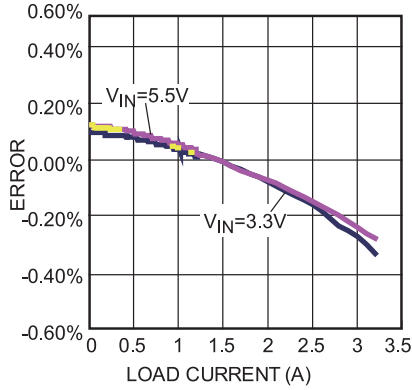

Line Regulation

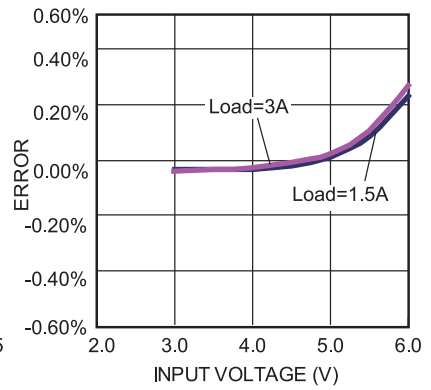

Quiescent Current vs. Temperature

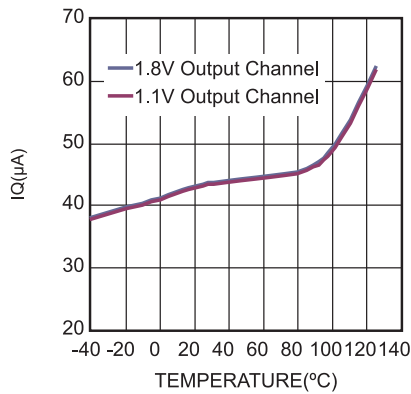

Case Temperature Rise ($T_{case}-T_{ambient}$) vs. I_{OUT}

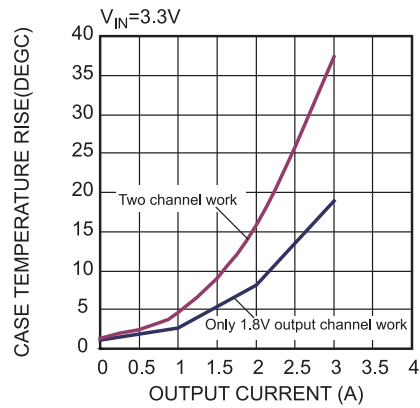

Output Voltage vs. Temperature

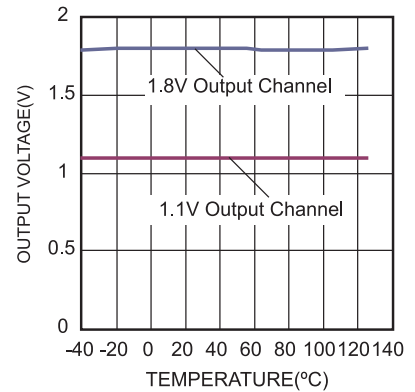

Feedback Voltage vs. Temperature

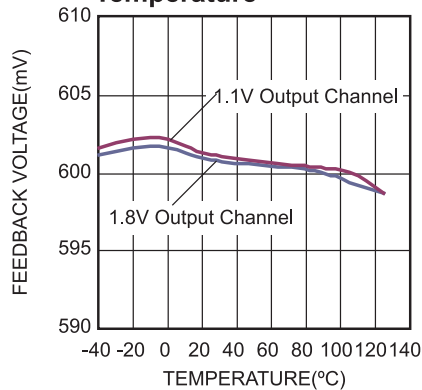

EVB TEST RESULTS (continued)

Performance waveforms are tested on the evaluation board.

$V_{IN} = 5V$, $V_{OUT1} = 1.1V$, $V_{OUT2} = 1.8V$, $L1=L2 = 1\mu H$, $C_{OUT1}=C_{OUT2}=22\mu F$, $T_A = 25^\circ C$, unless otherwise noted.

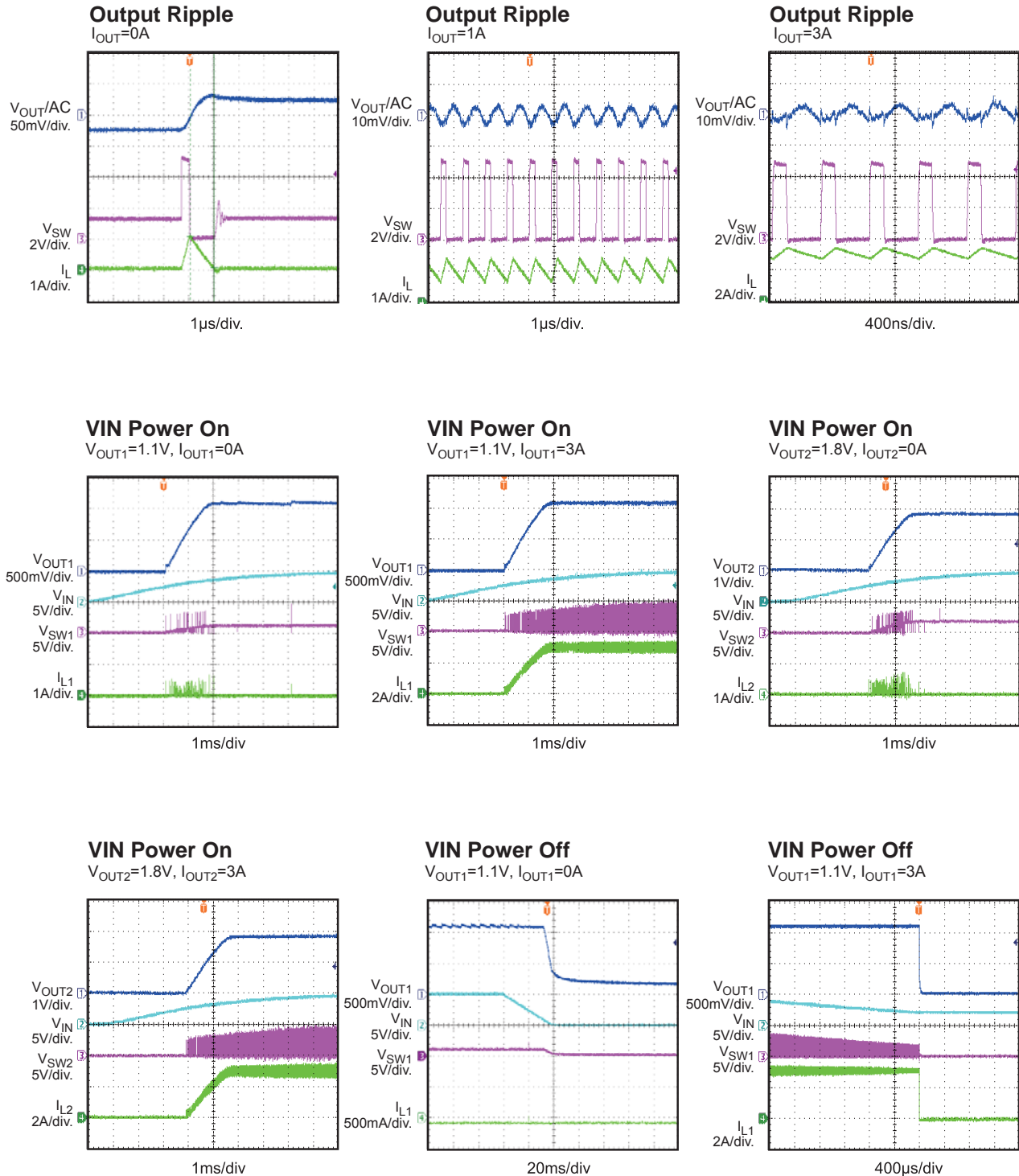

EVB TEST RESULTS (continued)

Performance waveforms are tested on the evaluation board.

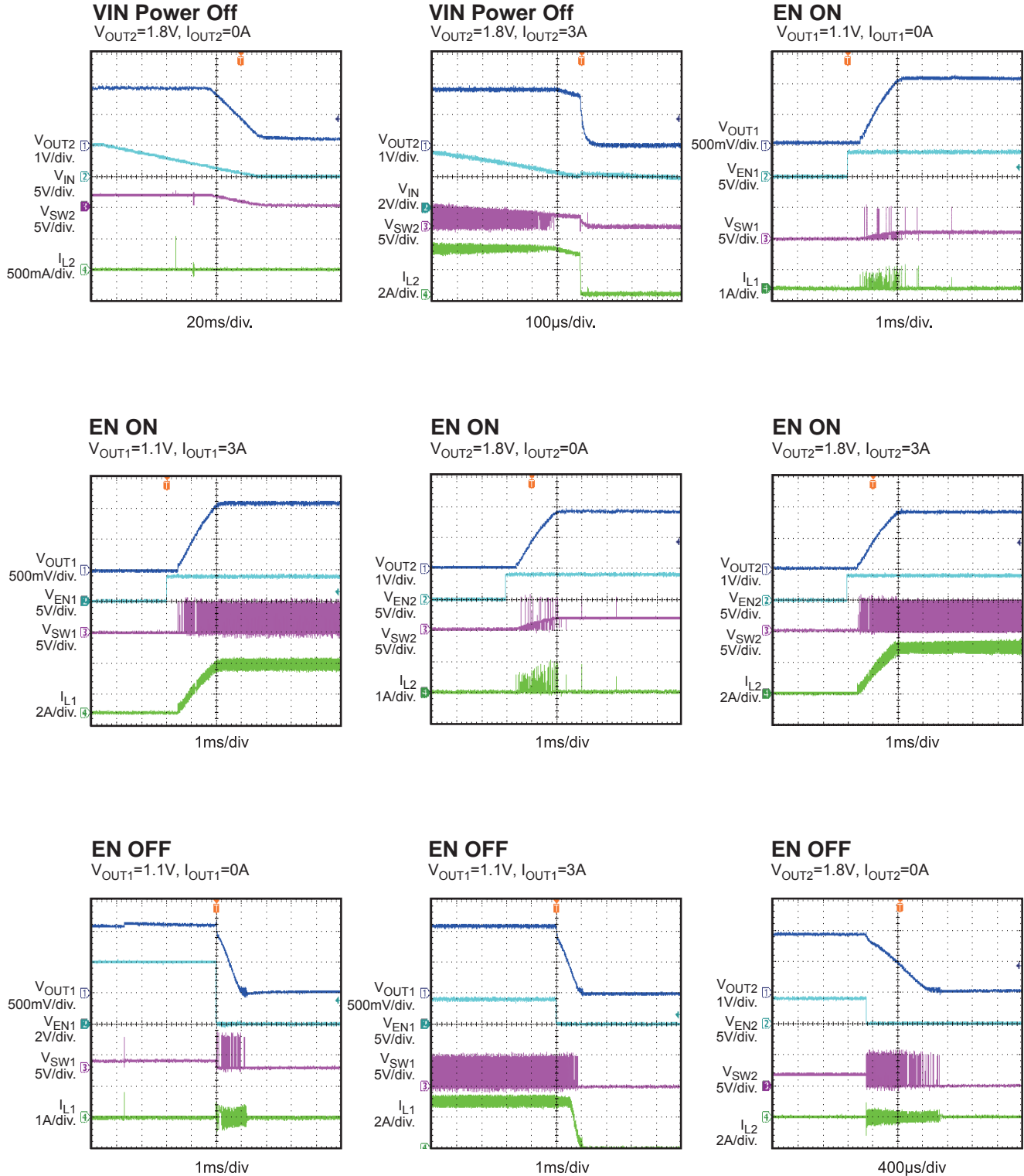
 $V_{IN} = 5V$, $V_{OUT1} = 1.1V$, $V_{OUT2} = 1.8V$, $L1=L2 = 1\mu H$, $C_{OUT1}=C_{OUT2}=22\mu F$, $T_A = 25^\circ C$, unless otherwise noted.

EVB TEST RESULTS (continued)

Performance waveforms are tested on the evaluation board.

$V_{IN} = 5V$, $V_{OUT1} = 1.1V$, $V_{OUT2} = 1.8V$, $L1=L2 = 1\mu H$, $C_{OUT1}=C_{OUT2}=22\mu F$, $T_A = 25^\circ C$, unless otherwise noted.

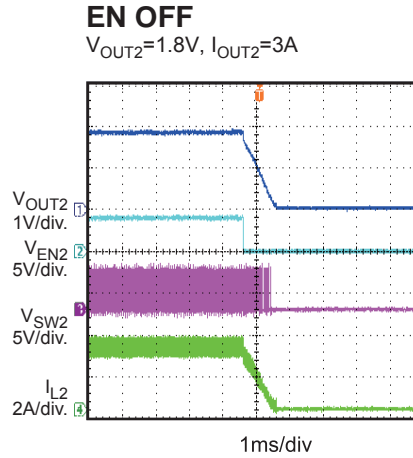

PRINTED CIRCUIT BOARD LAYOUT

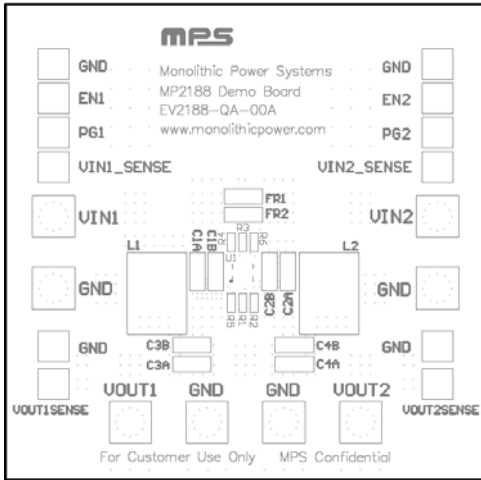

Figure 1—Top Silk Layer

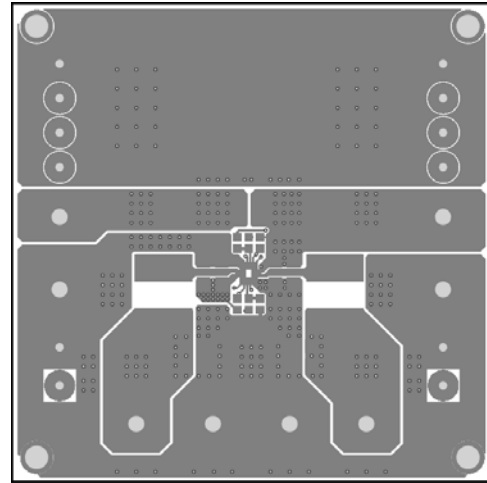

Figure 2—Top Layer

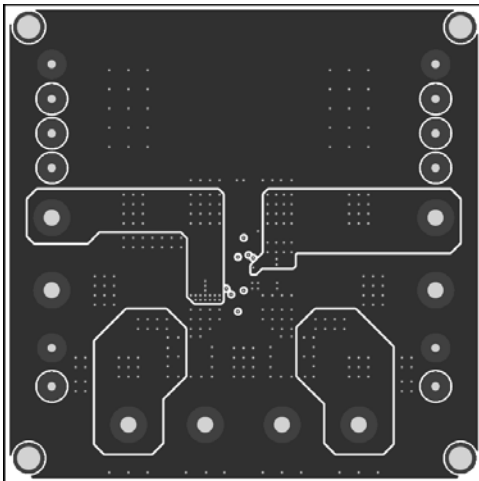

Figure 3—Inner 1 Layer

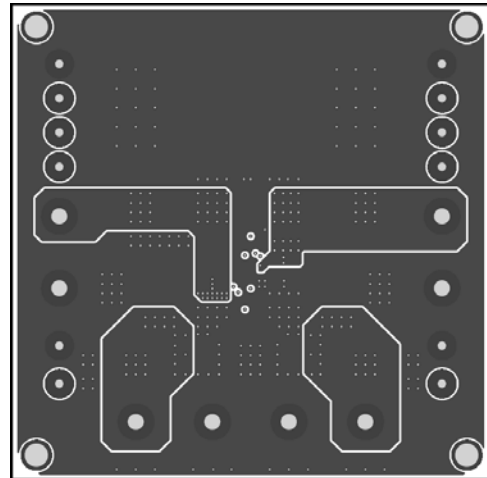

Figure 4—Inner 2 Layer

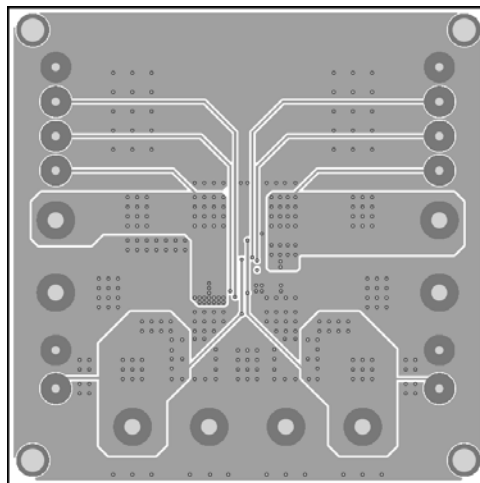
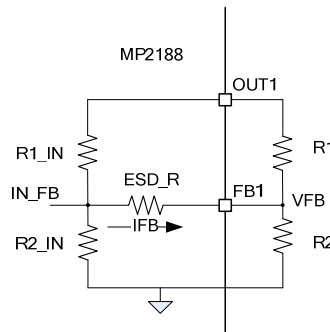

Figure 5—Bottom Layer

QUICK START GUIDE

1. Connect the positive and negative terminals of the load to the VOUT and GND pins, respectively.
2. Preset the power supply output between 3.6V and 5.5V, and then turn off the power supply.
3. Connect the positive and negative terminals of the power supply output to the VIN and GND pins, respectively.
4. Turn the power supply on. The board will automatically start up. And the output voltages are the pre-set fixed 1.1V and 1.8V.
5. To use the Enable function, apply a digital input to the EN pin. Drive EN higher than 1.2V to turn on the regulator or less than 0.4V to turn it off.
6. The output voltage of the two channels can be programmed by external FB divider resistors. Figure 6 shows the MP2188 feedback network.

Figure 6 — Feedback network

Considering the internal divider resistors, choose external FB divider resistors <20kΩ. Using below formulas to set the new output voltages:

$$I_{FB} = \frac{V_{OUT} - V_{CH}}{R1_IN}$$

$$V_{FB} = 0.6 - I_{FB} \times ESD_R$$

$$R_1 = \frac{V_{OUT} - V_{FB}}{V_{FB} - I_{FB} \times R_2} \times R_2$$

Where, V_{CH} is the pre-set fixed output voltage of each channel.

For channel 1: $V_{CH}=1.1V$, $R_{1_internal} = 214.58k\Omega$, $ESD_R=3.59k\Omega$.

For channel 2: $V_{CH}=1.8V$, $R_{1_internal} = 227.61k\Omega$, $ESD_R=4.28k\Omega$.

LAYOUT RECOMMENDATION OF MP2188

Proper layout of the switching power supplies is very important, and sometimes critical to make it work properly. Especially, for the high switching converter, if the layout is not carefully done, the regulator could show poor line or load regulation, stability issues.

For MP2188 layout, the high current paths (GND, IN, and SW) should be placed very close to the device using short, direct, and wide traces. The input capacitor needs to be as close as possible to the IN and GND pins. The external feedback resistors should be placed next to the FB pin. Keep the switching node SW short and away from the feedback network.

NOTICE: The information in this document is subject to change without notice. Users should warrant and guarantee that third party Intellectual Property rights are not infringed upon when integrating MPS products into any application. MPS will not assume any legal responsibility for any said applications.