



The Future of Analog IC Technology®

EV2172J-00A

2A, 5.5V, 2.6MHz Synchronous Step-Down Switcher Evaluation Board

DESCRIPTION

The EV2172-J-00A is used for demonstrating the performance of MPS's MP/MPQ2172, a low voltage high switching frequency step-down switcher with built in power MOSFETs. MP/MPQ2172 provides up to 2A highly efficient output with constant-on-time control for fast loop response.

MP/MPQ2172 is ideal for powering portable equipment that runs from a single cell Lithium-ion (Li+) Battery. The output voltage can be regulated as low as 0.6V.

High power efficiency over a wide load range is achieved by scaling down the switching frequency at light load to reduce the switching related loss by constant on time control. Short circuit and thermal shutdown provides reliable, fault-tolerant operation.

MP/MPQ2172 is available in TSOT23-8 package.

ELECTRICAL SPECIFICATION

| Parameter | Symbol | Value | Units |
|----------------|------------------|----------|-------|
| Input Voltage | V _{IN} | 2.5– 5.5 | V |
| Output Voltage | V _{OUT} | 1.2 | V |
| Output Current | I _{OUT} | 2 | A |

FEATURES

- Wide 2.5V to 5.5V Operating Input Range
- Up to 2A Output Current
- 40µA Quiescent Current
- 80mΩ and 45mΩ Internal Power MOSFET
- Default 2.6MHz Switching Frequency with 3.3V Input and 1.8V Output
- EN and Power Good for Power Sequencing
- Cycle-by-Cycle Over Current Protection
- Auto Discharge at Power Off
- Short Circuit Protection with Hiccup Mode
- Thermal Shutdown
- Stable with Low ESR Ceramic Output Capacitors
- Internal Soft-Start
- Available in a TSOT23-8 Package
- Available in AEC-Q100 Grade 1

APPLICATIONS

- Automotive Infotainment
- Automotive Clusters
- Automotive Telematics
- Low-Voltage I/O System Power
- Handheld/Battery-Powered Systems

All MPS parts are lead-free, halogen-free, and adhere to the RoHS directive. For MPS green status, please visit the MPS website under Quality Assurance. "MPS" and "The Future of Analog IC Technology" are registered trademarks of Monolithic Power Systems, Inc.

EV2172-J-00A EVALUATION BOARD



(L × W × H) 6.35cm × 6.35cm × 1.2cm

| Board Number | MPS IC Number |
|--------------|---------------|
| EV2172-J-00A | MP/MPQ2172DJ |

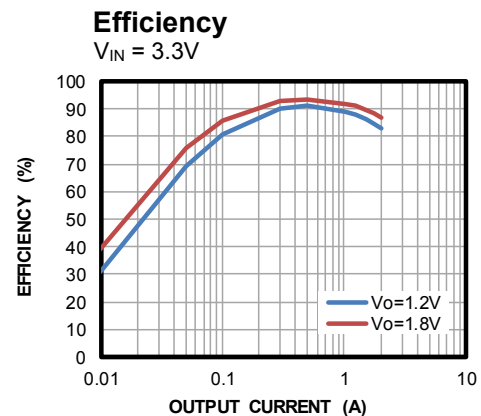

EVALUATION BOARD SCHEMATIC

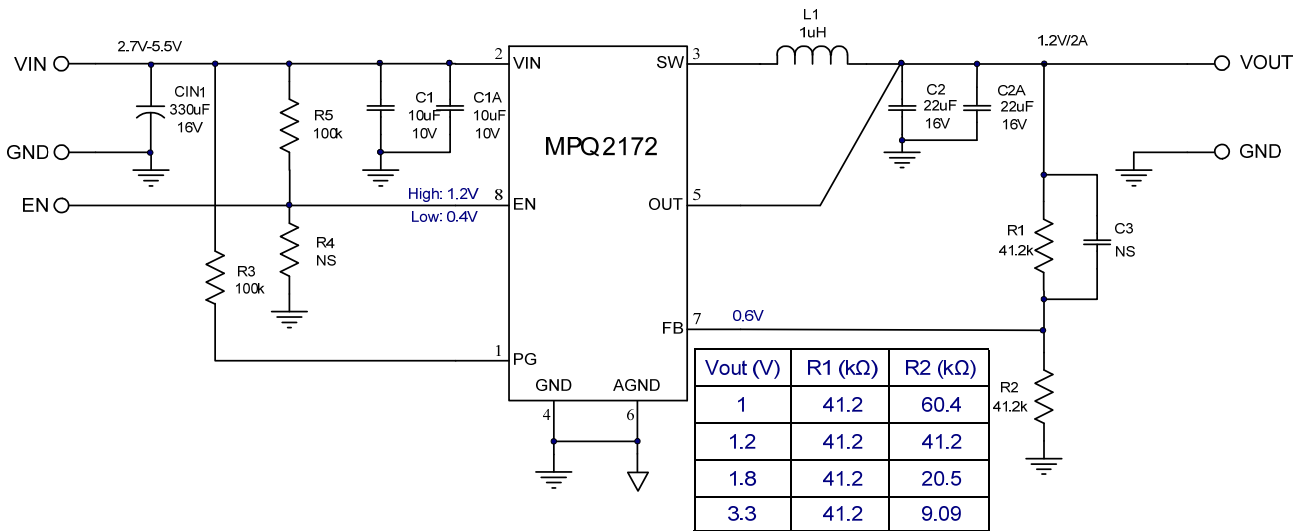

Package Reference

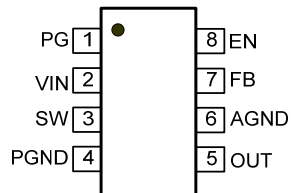

| | | | |
|---------------------|---------------------|------|-----|
| Switching Frequency | Vin=3.3V, Vout=1.2V | 2400 | kHz |
| | Vin=3.3V, Vout=1.8V | 2600 | |
| | Vin=5V, Vout=1.2V | 2200 | |
| | Vin=5V, Vout=1.8V | 2380 | |

EV2172-J-00A BILL OF MATERIALS

| Qty | Designator | Value | Description | Package | Manufacture | Manufacture_PN |
|-----|--------------------------------------|-------------|--|-----------|-------------|--------------------|
| 1 | CIN1 | 330 μ F | Electronic Ceramic Cap 10V, 330 μ F, 17m Ω | SMD | Panasonic | 10SVP330M |
| | C2A, C3 | NS | | | | |
| 2 | C1, C1A | 10 μ F | Ceramic Cap 10V, 20%, X5R | 1206 | Taiyo Yuden | LMK212BJ106MG-T |
| 1 | C2 | 22 μ F | Ceramic Cap 6.3V, 10%, X5R | 1206 | muRata | GRM218R70J226KE76L |
| 1 | L1 | 1 μ H | Inductor, 6.4A, 8.8m Ω | 7.3x6.8mm | TDK | RLF7030-1R0N6R4 |
| | | 1 μ H | Inductor, 6.4A, 8.4m Ω | 7.3x7.3mm | Würth | 744777001 |
| | | 1 μ H | Inductor, 6.4A, 8.8m Ω | 5x5mm | Delta | PCMC053T-1R0MN |
| 2 | R1,R2 | 41.2k | Film Res 1% | 0603 | Yageo | RC0603FR-0741K2L |
| 2 | R3,R5 | 100k | Film Res 1% | 0603 | Yageo | RC0603FR-074100KL |
| 1 | R4 | NS | | | | |
| 1 | U1 | | Synchronous Step- Down converter | TSOT23-8 | MPS | MP/MPQ2172GJ |
| 4 | VIN, VOUT,GND | | 2.0 Golden Pin | | HZ | |
| 9 | EN, PG,VINSENSE, VOUTSENSE, SW | | 1.0 Golden Pin | | HZ | |

EVB TEST RESULTS

Performance waveforms are tested on the evaluation board.

$V_{IN} = 3.3V$, $V_{OUT} = 1.2V$, $L = 1\mu H$, $C_{OUT} = 22\mu F$, $T_A = +25^\circ C$, unless otherwise noted.

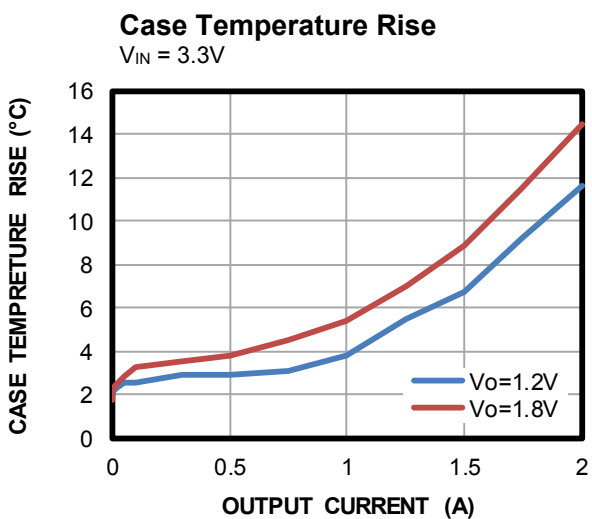
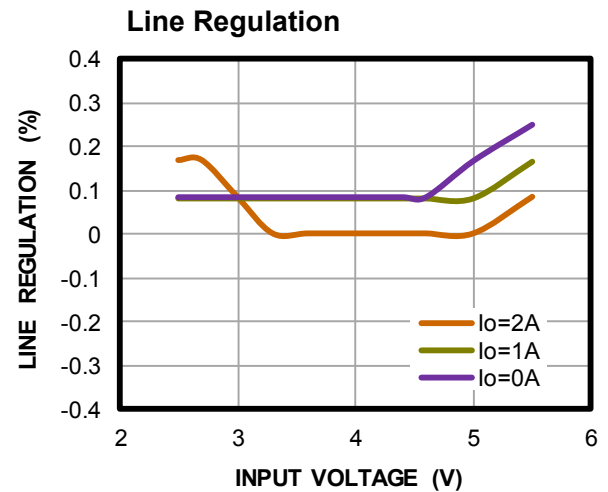
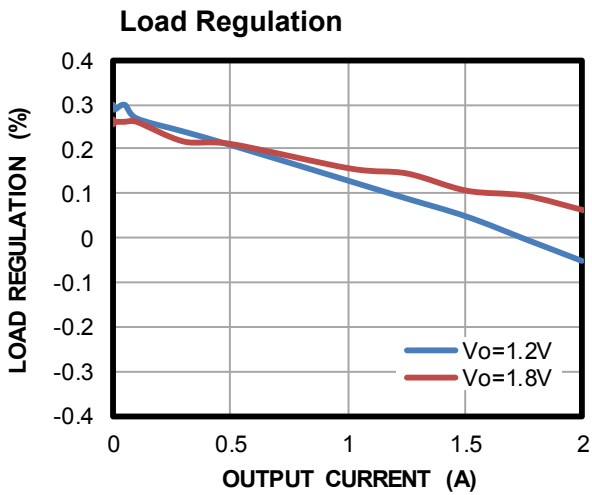
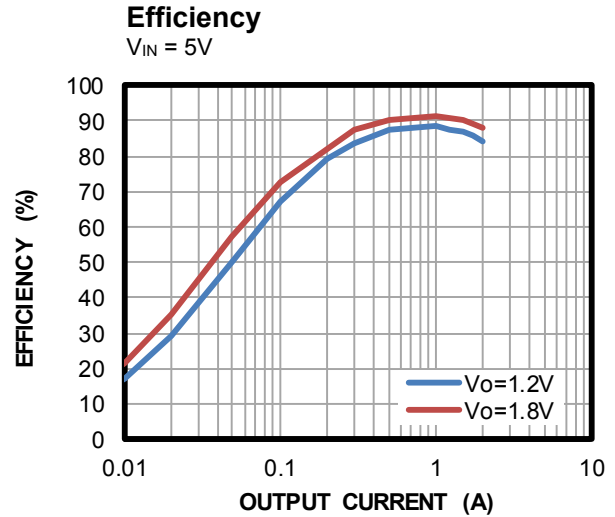
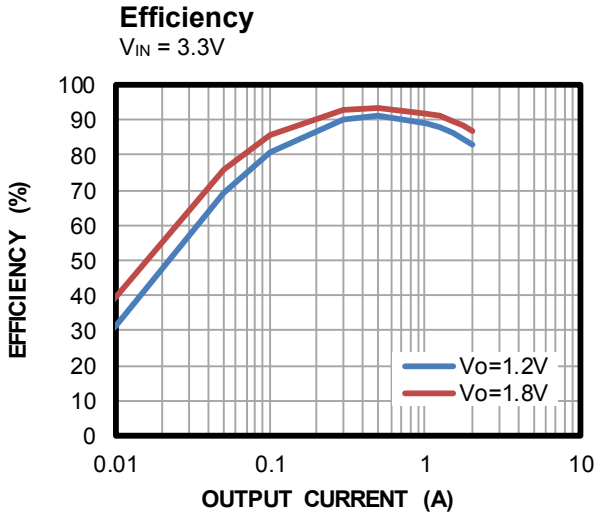

EVB TEST RESULTS (continued)

Performance waveforms are tested on the evaluation board.

$V_{IN} = 3.3V$, $V_{OUT} = 1.2V$, $L = 1\mu H$, $C_{OUT} = 22\mu F$, $T_A = +25^\circ C$, unless otherwise noted.

Output Ripple

$I_{OUT} = 0A$

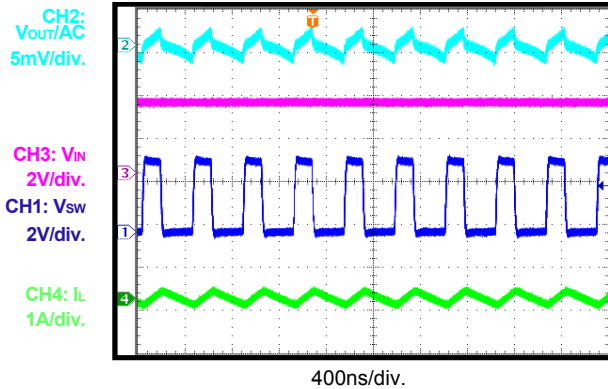

Output Ripple

$I_{OUT} = 2A$

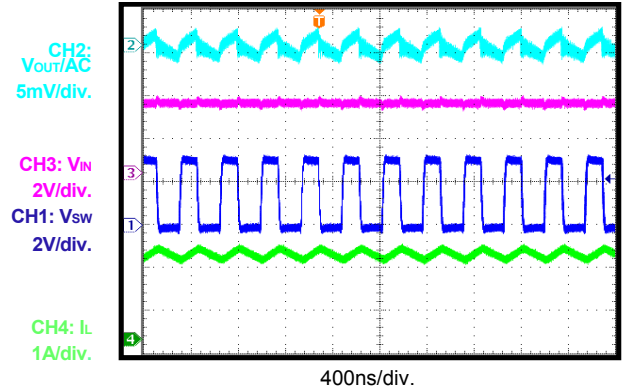

Start-Up through V_{IN}

$I_{OUT} = 0A$

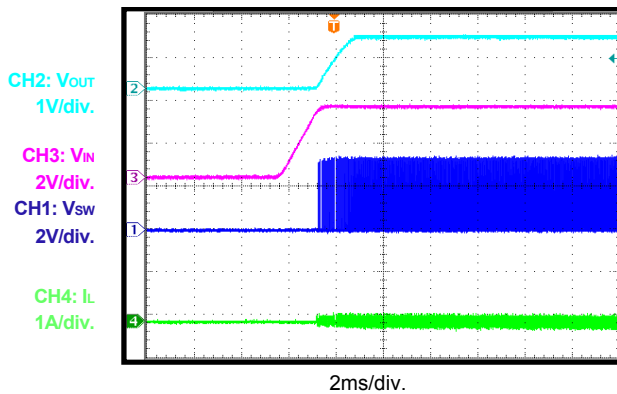

Start-Up through V_{IN}

$I_{OUT} = 2A$

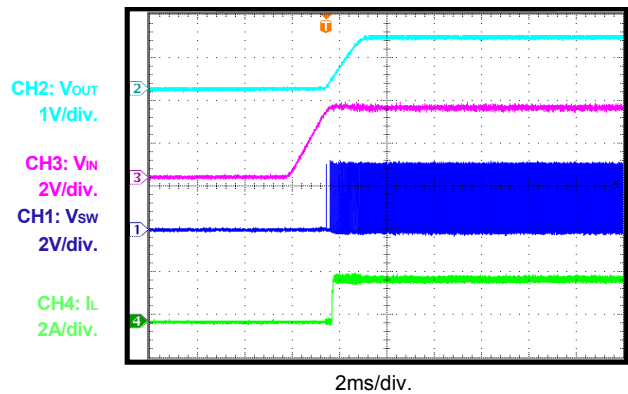

Shutdown through V_{IN}

$I_{OUT} = 0A$

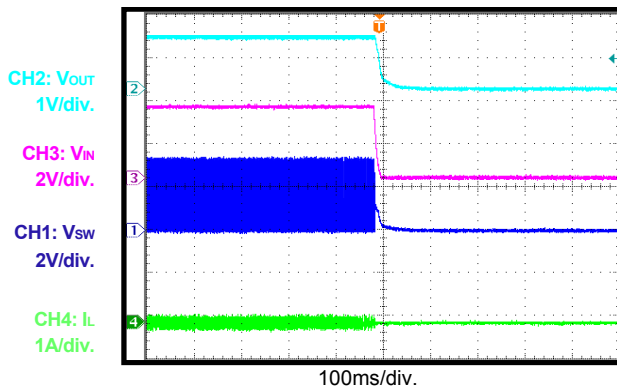

Shutdown through V_{IN}

$I_{OUT} = 2A$

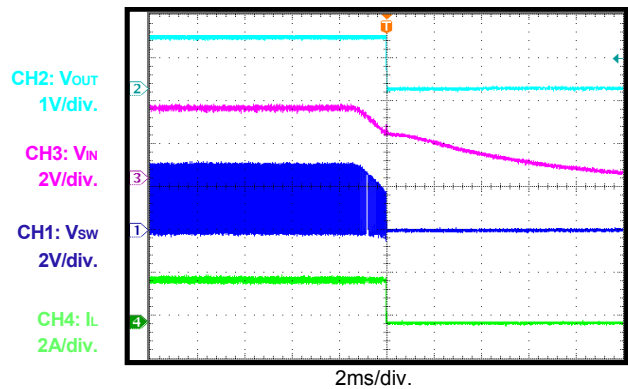

EVB TEST RESULTS *(continued)*

Performance waveforms are tested on the evaluation board.

$V_{IN} = 3.3V$, $V_{OUT} = 1.2V$, $L = 1\mu H$, $C_{OUT} = 22\mu F$, $T_A = +25^\circ C$, unless otherwise noted.

Start-Up through EN

$I_{OUT} = 0A$

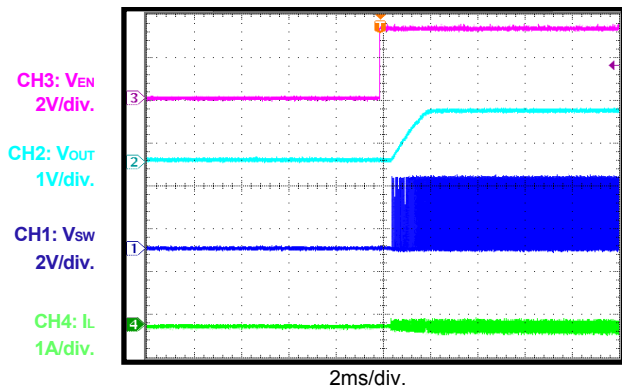

Start-Up through EN

$I_{OUT} = 2A$

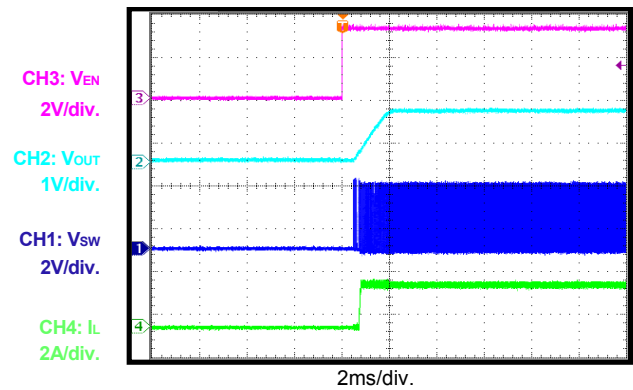

Shutdown through EN

$I_{OUT} = 0A$

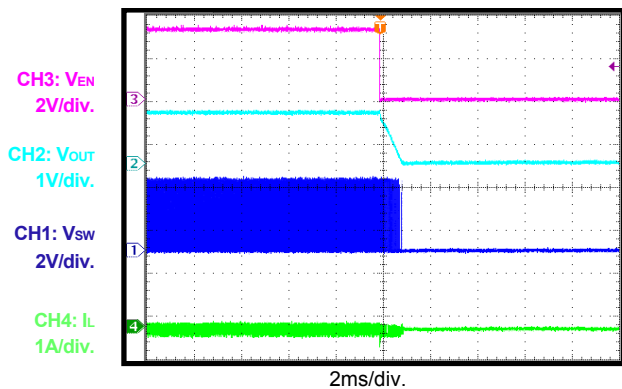

Shutdown through EN

$I_{OUT} = 2A$

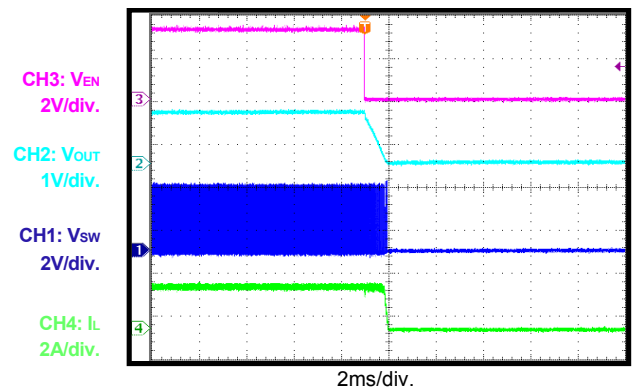

PG in Start-Up through V_{IN}

$I_{OUT} = 2A$

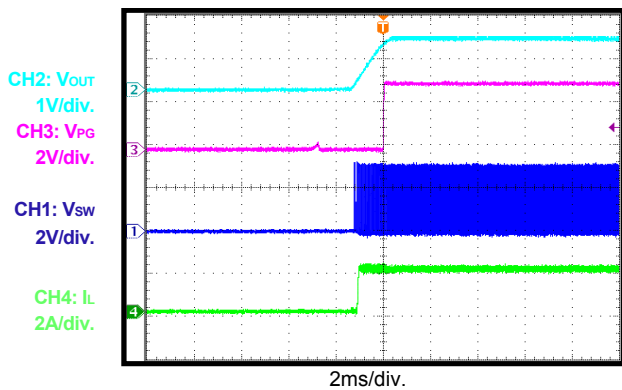

PG in Shutdown through V_{IN}

$I_{OUT} = 2A$

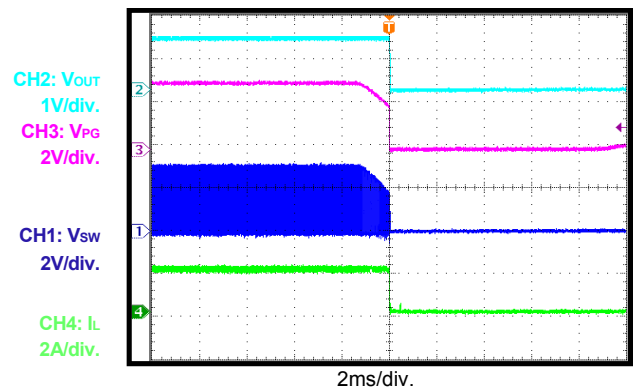

EVB TEST RESULTS *(continued)*

Performance waveforms are tested on the evaluation board.

$V_{IN} = 3.3V$, $V_{OUT} = 1.2V$, $L = 1\mu H$, $C_{OUT} = 22\mu F$, $T_A = +25^\circ C$, unless otherwise noted.

PG in Start-Up through EN

$I_{OUT} = 2A$

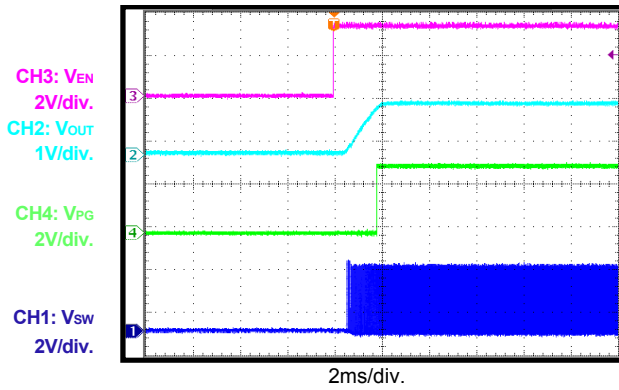

PG in Shutdown through EN

$I_{OUT} = 2A$

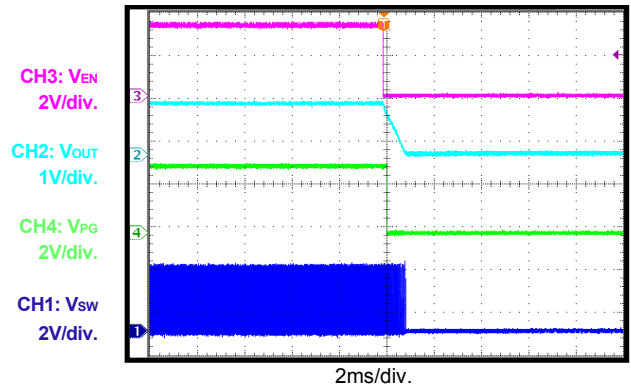

SCP Entry

$I_{OUT} = 0A$

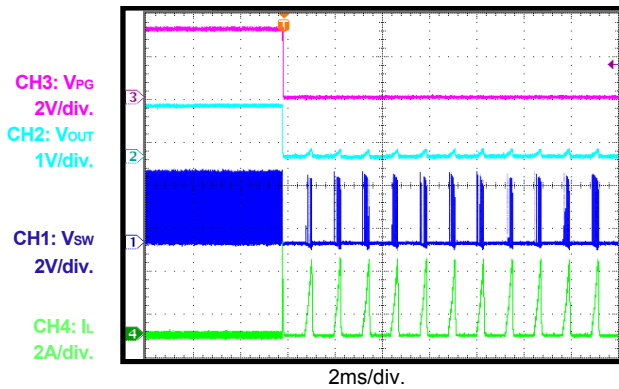

SCP Entry

$I_{OUT} = 2A$

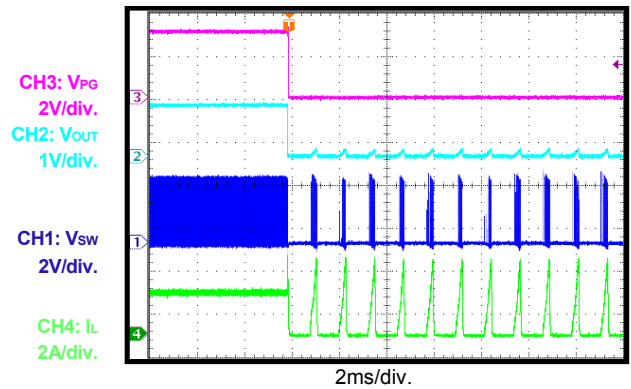

SCP Recovery

$I_{OUT} = 0A$

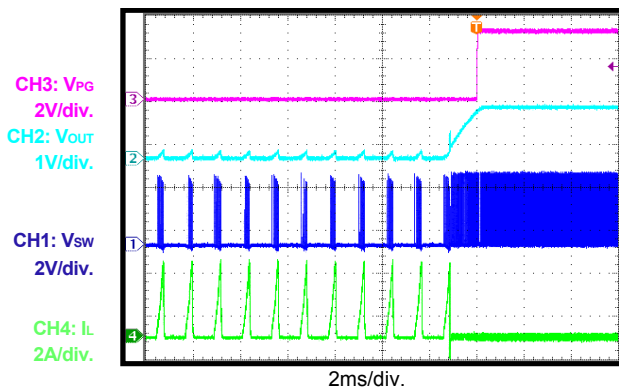

SCP Recovery

$I_{OUT} = 2A$

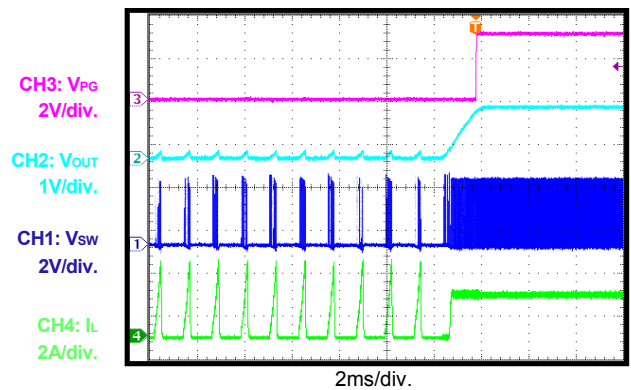

EVB TEST RESULTS *(continued)*

Performance waveforms are tested on the evaluation board.

$V_{IN} = 3.3V$, $V_{OUT} = 1.2V$, $L = 1\mu H$, $C_{OUT} = 22\mu F$, $T_A = +25^\circ C$, unless otherwise noted.

SCP Steady State

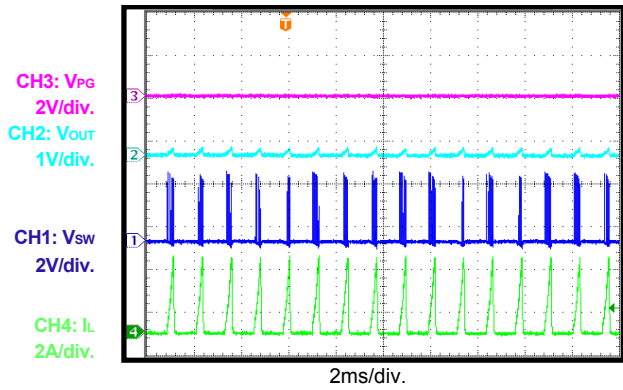

Load Transient Response

$I_{OUT} = 0 - 2A$

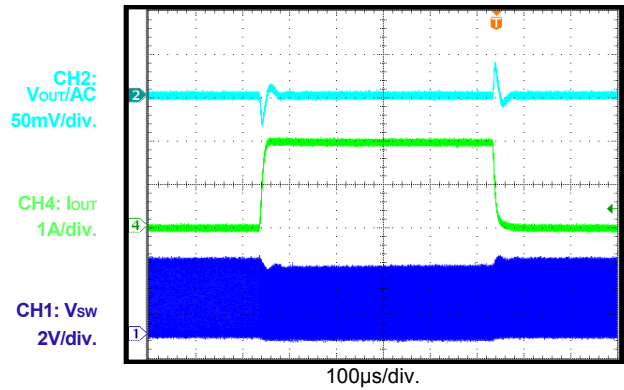

PRINTED CIRCUIT BOARD LAYOUT

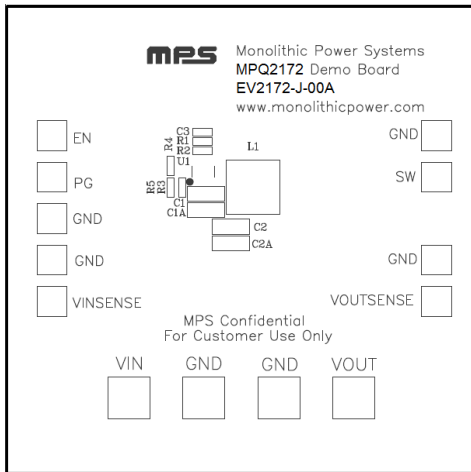

Figure 1—Top Silk Layer

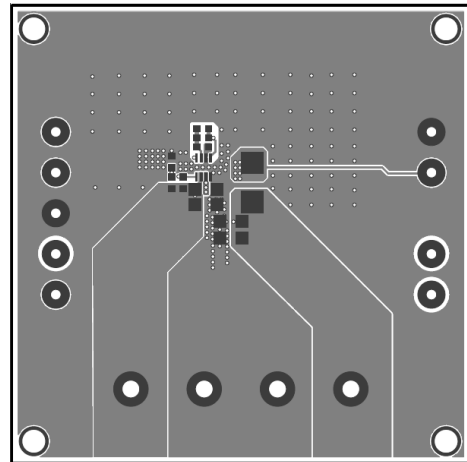

Figure 2—Top Layer

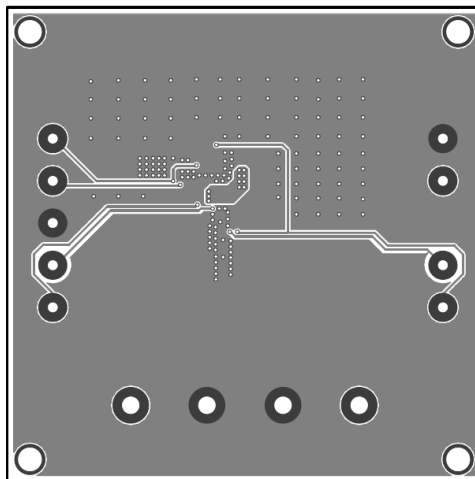

Figure 3— Bottom Layer

QUICK START GUIDE

1. Connect the positive and negative terminals of the load to the VOUT and GND pins, respectively.
2. Preset the power supply output between 2.5V and 5.5V, and then turn off the power supply.
If longer cables are used between the source and the EVB (>0.5m total), a damping capacitor should be installed at the input terminals.
3. Connect the positive and negative terminals of the power supply output to the VIN and GND pins, respectively.
4. Turn the power supply on. The MP/MPQ2172GJ will automatically start up.
5. To use the Enable function, apply a digital input to the EN pin. Drive EN higher than 1.2V to turn on the regulator or less than 0.4V to turn it off.
6. The output voltage is set by the external resistor divider. Choose R1 to be around 41.2kΩ. Then R2 can be calculated with below equation:

$$R2 = \frac{R1}{\frac{V_{out}}{0.6} - 1}$$

The feedback circuit is shown in below Figure:

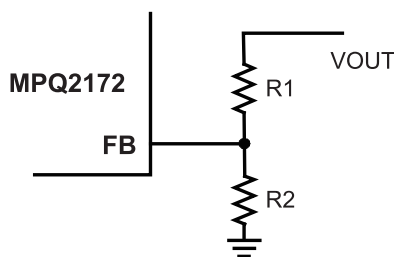

Below table lists the recommended feedback resistor values for common output voltages.

| V _{OUT} (V) | R1 (kΩ) | R2 (kΩ) |
|----------------------|-----------|-----------|
| 1.0 | 41.2 (1%) | 60.4 (1%) |
| 1.2 | 41.2 (1%) | 41.2 (1%) |
| 1.8 | 41.2 (1%) | 20.5(1%) |
| 3.3 | 41.2 (1%) | 9.09(1%) |

NOTICE: The information in this document is subject to change without notice. Please contact MPS for current specifications. Users should warrant and guarantee that third party Intellectual Property rights are not infringed upon when integrating MPS products into any application. MPS will not assume any legal responsibility for any said applications.