



The Future of Analog IC Technology®

EV2169-RH-00A

6V, Dual 3A/1A or 2A/2A
Low IQ, Synchronous Buck
with PG and SS
Evaluation Board

DESCRIPTION

The EV2169-RH-00A is an evaluation board for the MPQ2169, an internally compensated, dual, PWM, synchronous, step-down regulator that operates from a 2.7V to 6V input and generates an output voltage as low as 0.6V.

The MPQ2169 can be configured as a 2A/2A or 3A/1A output current regulator and is ideal for powering portable equipment that runs on a single-cell lithium-ion (Li+) battery due to a low 60µA quiescent current.

The MPQ2169 integrates dual, 55mΩ, high-side switches and 20mΩ synchronous rectifiers for high efficiency without an external Schottky diode. The MPQ2169 has peak-current-mode control and internal compensation and is capable of low dropout configurations. Both channels can operate at 100% duty cycle.

Fault condition protections include cycle-by-cycle current limit and thermal shutdown.

The EV2169-RH-00A is assembled and tested with a QFN-18 (2.5mmx3.5mm) package.

ELECTRICAL SPECIFICATIONS

Parameter	Symbol	Value	Units
Input Voltage	V _{IN}	2.7-6	V
Output Voltage	V _{OUT}	1.8/1.2	V
Output Current	I _{OUT}	3/1 or 2/2	A

FEATURES

- 2.7V to 6V Operating Input Range
- 3A/1A or 2A/2A Output Current
- Programmed Frequency up to 3MHz
- External Sync Clock Up to 3MHz
- 180° Phase Shifted Operation
- PG Indicators
- External SS and Track
- Adjustable Advanced Asynchronous Mode (AAM) or Forced Continuous Conduction Mode (CCM)
- Peak Efficiency >90%
- Output Adjustable from 0.6V to V_{IN}
- 100% Duty Cycle Operation
- Fully Assembled and Tested

APPLICATIONS

- Small/Handheld Devices
- DVD Drivers
- Smart phones and Feature Phones
- Battery-Powered Devices
- Portable Instruments

All MPS parts are lead-free, halogen-free, and adhere to the RoHS directive. For MPS green status, please visit the MPS website under Quality Assurance.

"MPS" and "The Future of Analog IC Technology" are registered trademarks of Monolithic Power Systems, Inc.

EV2169-RH-00A EVALUATION BOARD



(L x W x H) 2.5" x 2.5" x 0.2"
(6.35cm x 6.35cm x 0.5cm)

Board Number	MPS IC Number
EV2169-RH-00A	MPQ2169

Efficiency vs. Load Current

$V_{OUT1}=1.8V$, AAM, one channel on,
 $L=1.5\mu H$, $F_{sw}=2.25MHz$

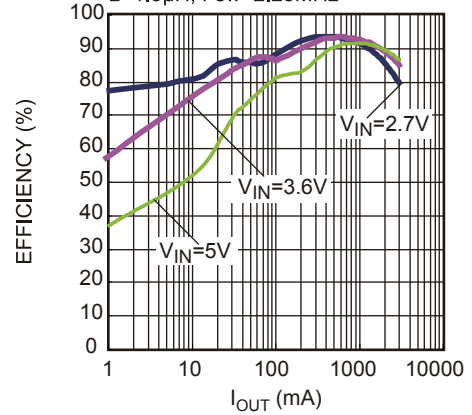

EVALUATION BOARD SCHEMATIC

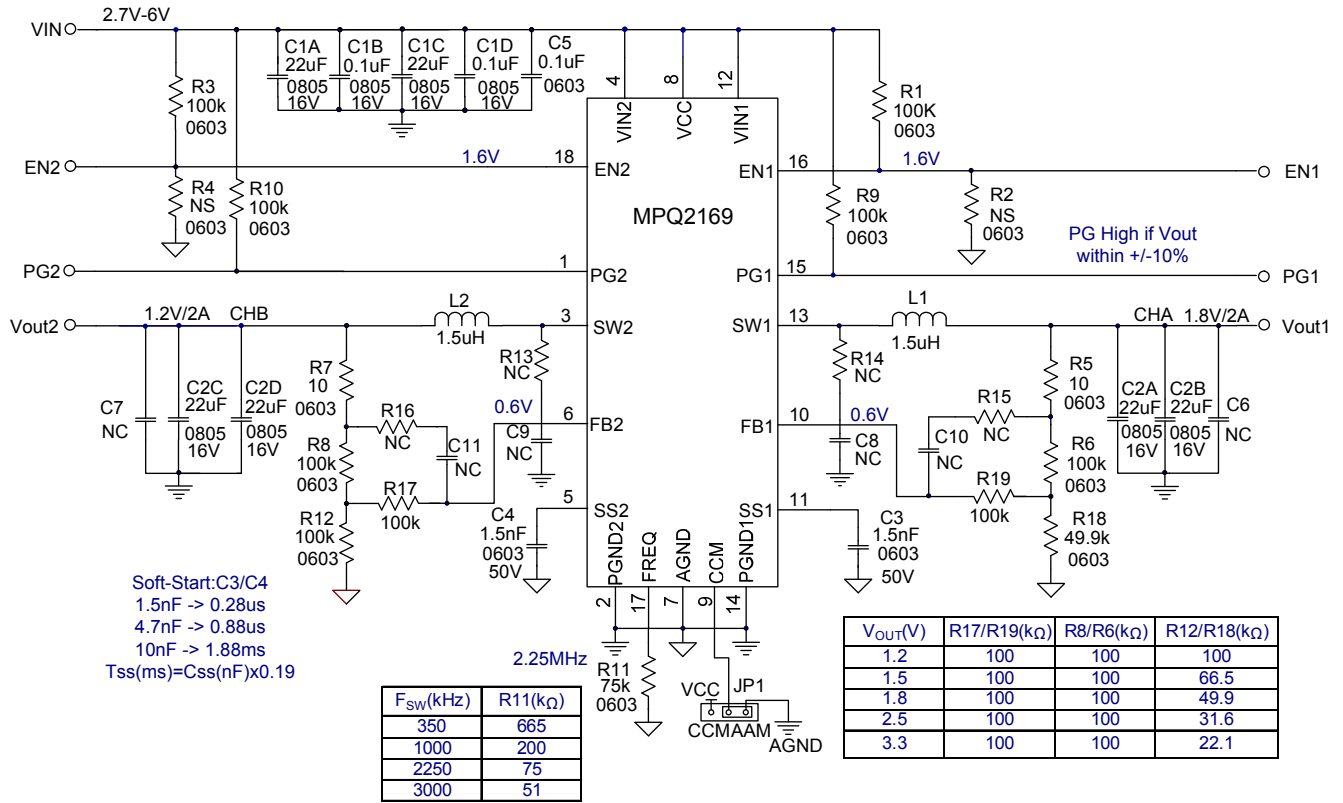

PACKAGE REFERENCE

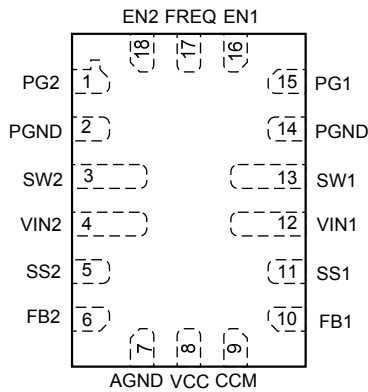

EV2169-RH-00A BILL OF MATERIALS

RefDes	Value	Description	Package	Manufacturer	Manufacturer_P/N
C1A, C1C, C2A, C2B C2C, C2D	22μF	Ceramic Cap;16V;X5R	0805	muRata	GRM21BR61C226ME44L
C1B, C1D	0.1μF	Ceramic Cap;16V;X7R	0805	muRata	GRM219R71C104KA01D
C3, C4	1.5nF	Ceramic Cap;50V;X7R	0603	muRata	GRM188R71H153KA01D
C5	0.1μF	Ceramic Cap;16V;X5R	0603	muRata	GRM188R61C104KA01D
C6, C7, C8, C9, C10, C11	NS				
L1, L2	1.5μH	Inductor; 1.5uH; 15.8m; 9.1A	SMD	Coilcraft	XFL4020-152MEB
R1,R3,R6, R8,R9, R10,R12, R17,R19	100K	Film Resistor;1%;	0603	Yageo	RC0603FR-07100KL
R5,R7	10	Film Resistor;1%;	0603	Yageo	RC0603FR-0710RL
R2, R4, R13, R14,R15, R16	NS				
R11	75K	Film Resistor;1%;	0603	Yageo	RC0603FR-0775KL
U1		Step-Down Converter	QFN-18 (2.5x3.5mm)	MPS	MPQ2169GRH
CN1		Connector; 2.54mm;		any	
VIN, VEMI,GND, GND, VOUT1, VOUT2	Test Point	2.0 Golden Pin		HZ	

EVB TEST RESULTS

$V_{IN} = 5V$, $V_{OUT1} = 1.8V$, $V_{OUT2} = 1.2V$, $L1 = L2 = 1.5\mu H$, $F_{SW} = 2.25MHz$, $T_A = 25^\circ C$, unless otherwise noted.

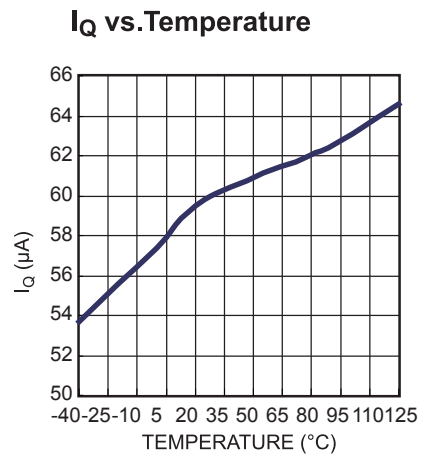
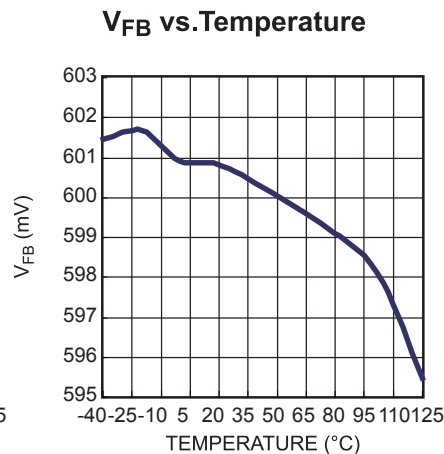
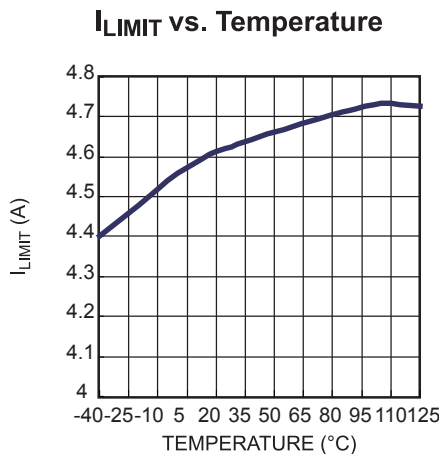
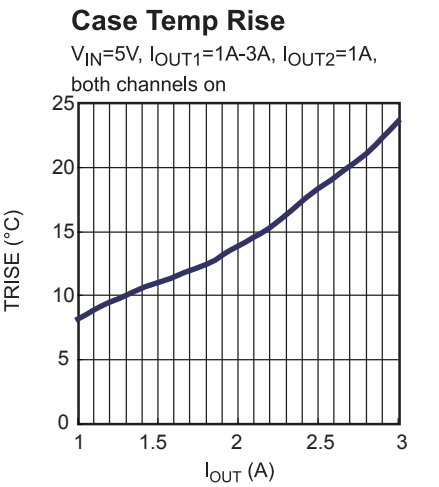
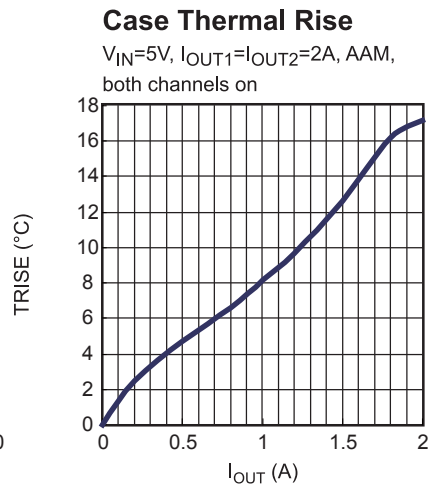
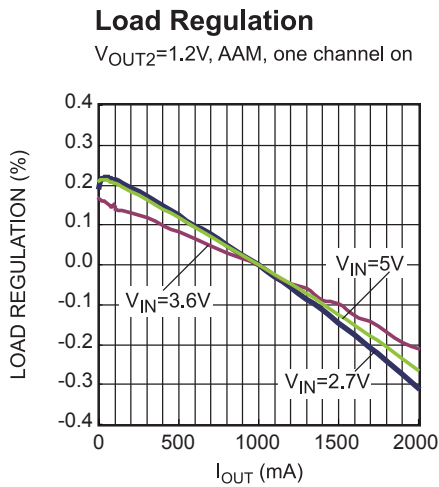
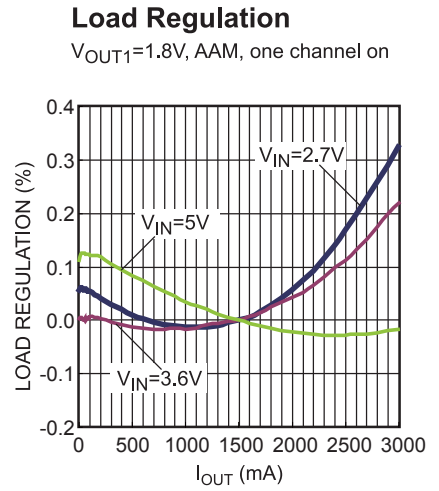
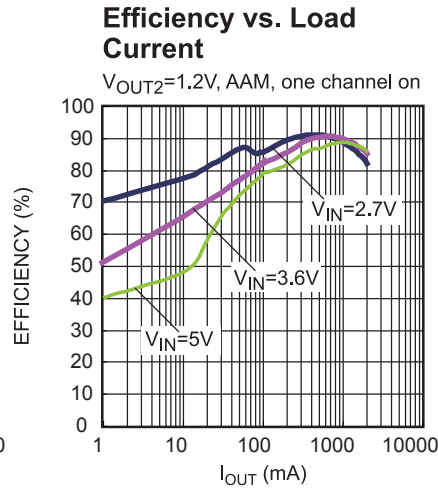
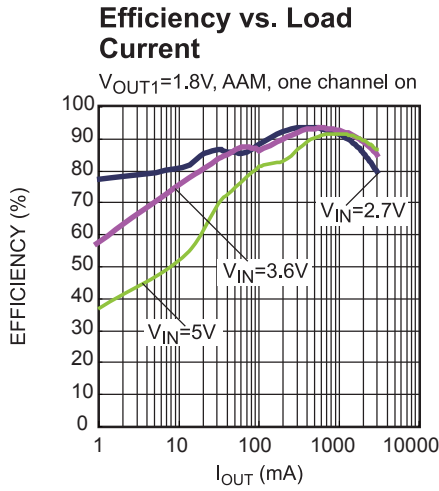

EVB TEST RESULTS

$V_{IN} = 5V$, $V_{OUT1} = 1.8V$, $V_{OUT2} = 1.2V$, $L1 = L2 = 1.5\mu H$, $F_{SW} = 2.25MHz$, $T_A = 25^\circ C$, unless otherwise noted.

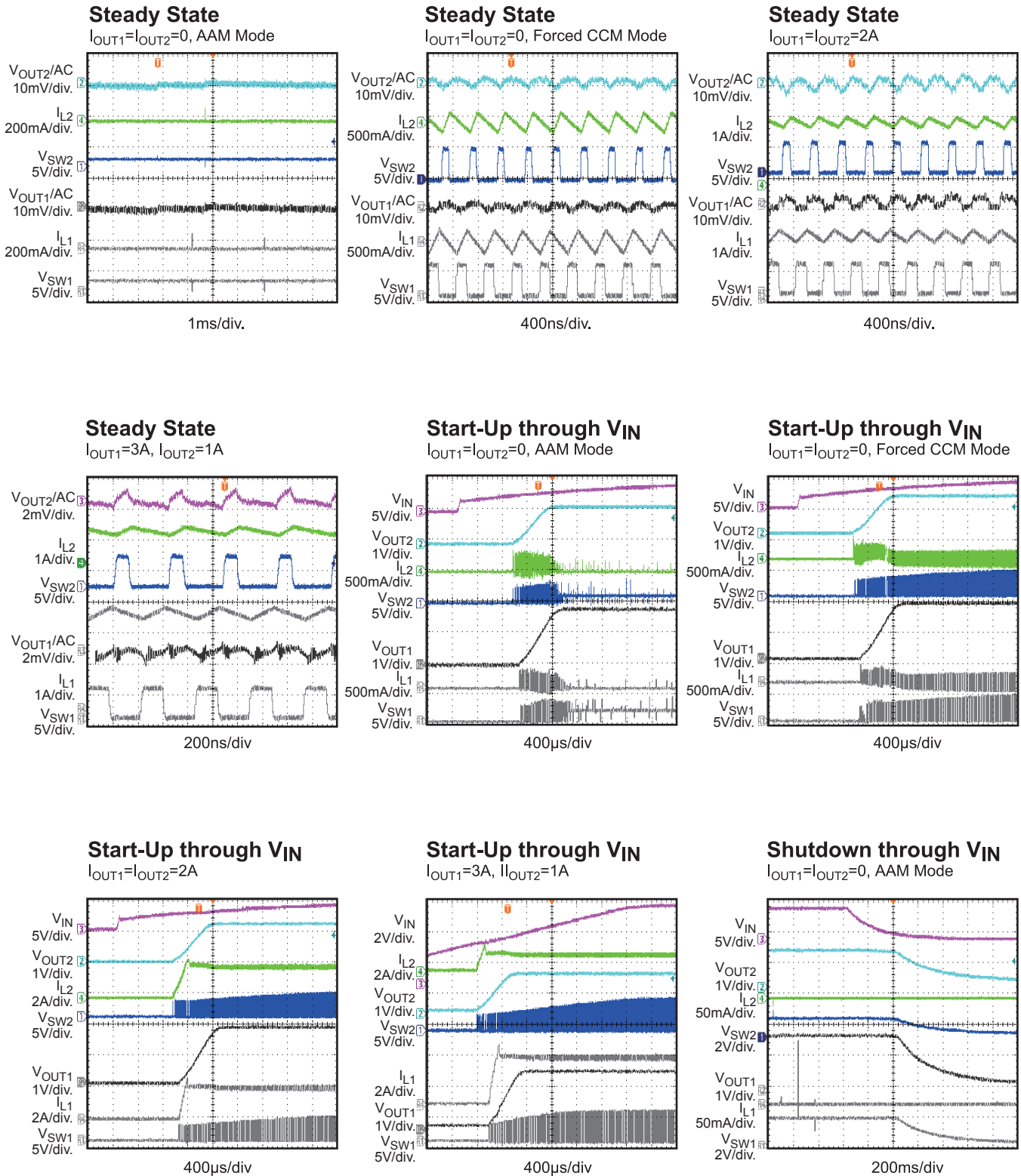

EVB TEST RESULTS

$V_{IN} = 5V$, $V_{OUT1} = 1.8V$, $V_{OUT2} = 1.2V$, $L1 = L2 = 1.5\mu H$, $F_{SW} = 2.25MHz$, $T_A = 25^\circ C$, unless otherwise noted.

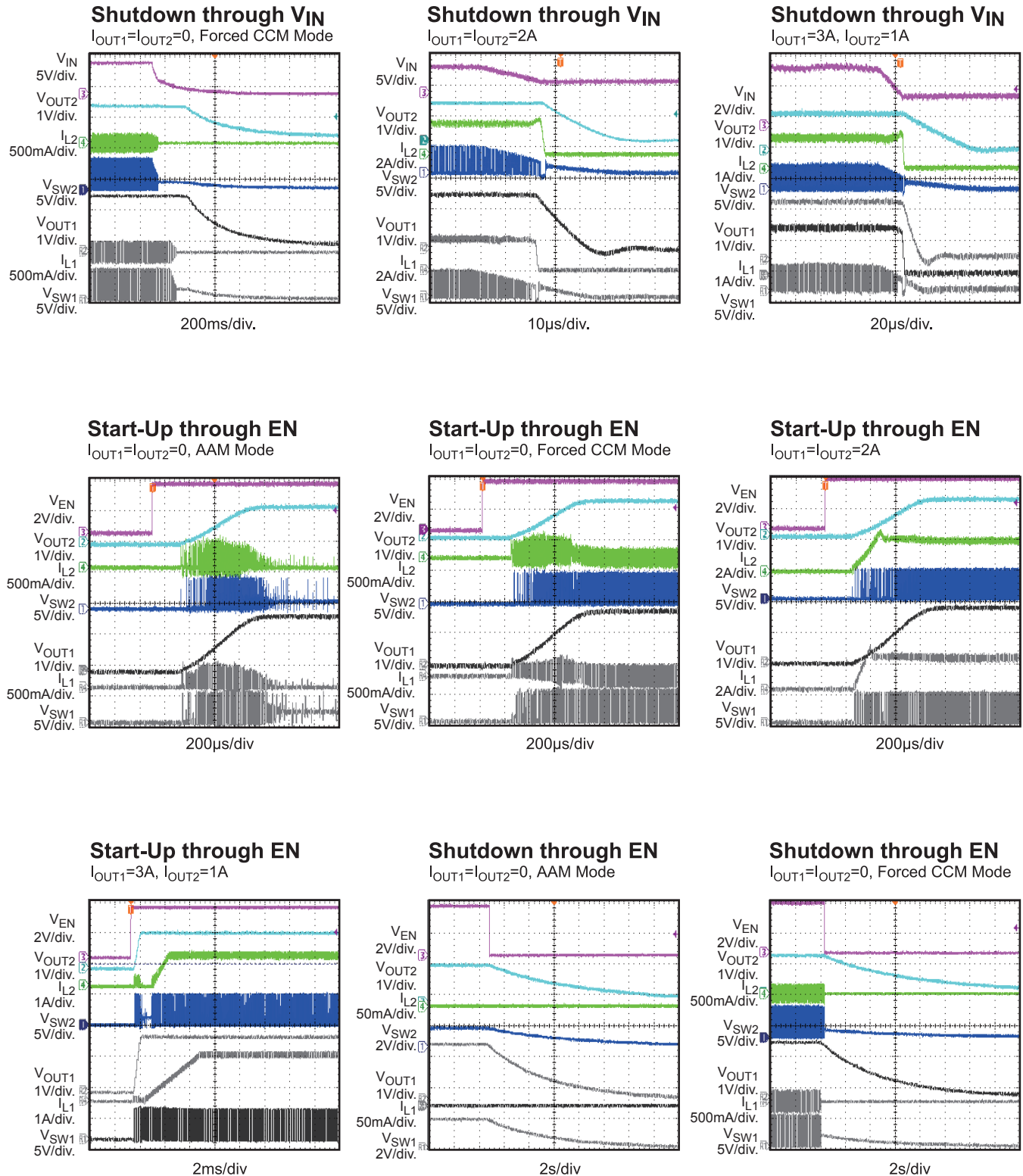

EVB TEST RESULTS

$V_{IN} = 5V$, $V_{OUT1} = 1.8V$, $V_{OUT2} = 1.2V$, $L1 = L2 = 1.5\mu H$, $F_{SW} = 2.25MHz$, $T_A = 25^\circ C$, unless otherwise noted.

Shutdown through EN

$I_{OUT1}=I_{OUT2}=2A$

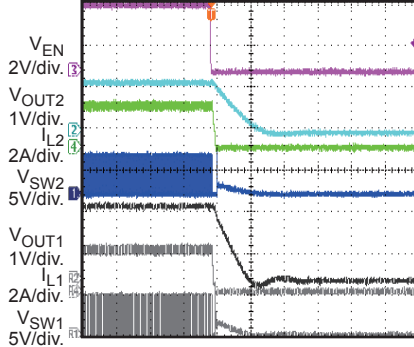

20 μs /div.

Shutdown through EN

$I_{OUT1}=3A$, $I_{OUT2}=1A$

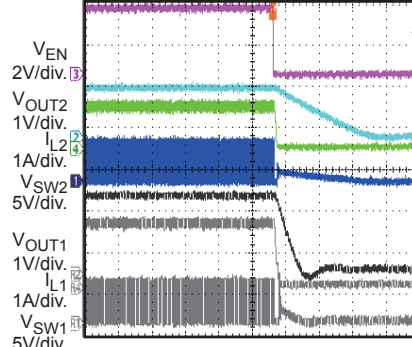

20 μs /div.

SCP Entry

$I_{OUT1}=I_{OUT2}=0$, AAM Mode

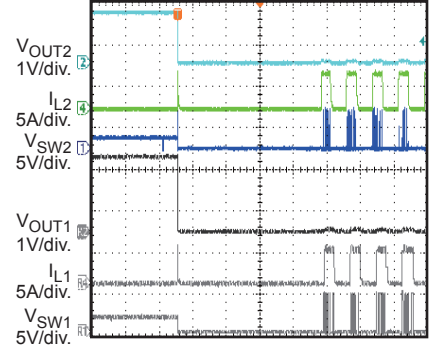

2ms/div.

SCP Entry

$I_{OUT1}=I_{OUT2}=0$, Forced CCM Mode

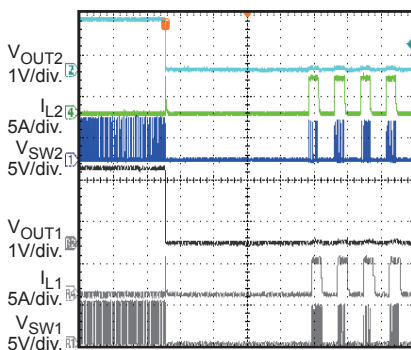

2ms/div

SCP Entry

$I_{OUT1}=I_{OUT2}=2A$

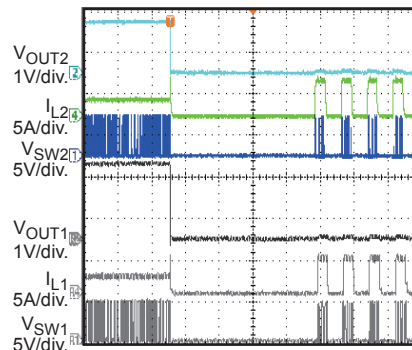

2ms/div

SCP Entry

$I_{OUT1}=3A$, $I_{OUT2}=1A$

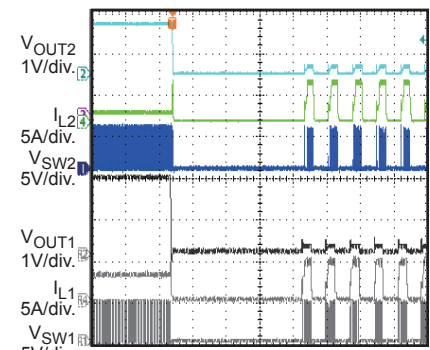

2ms/div

SCP Recovery

$I_{OUT1}=I_{OUT2}=0$, AAM Mode

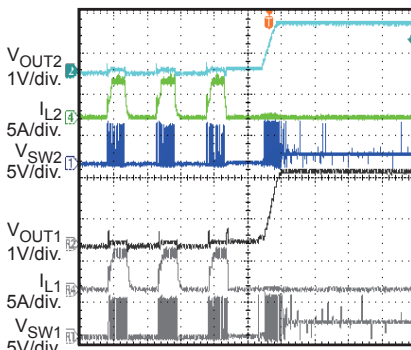

1ms/div

SCP Recovery

$I_{OUT1}=I_{OUT2}=0$, Forced CCM Mode

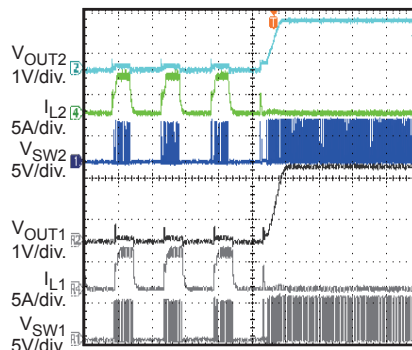

1ms/div

SCP Recovery

$I_{OUT1}=I_{OUT2}=2A$

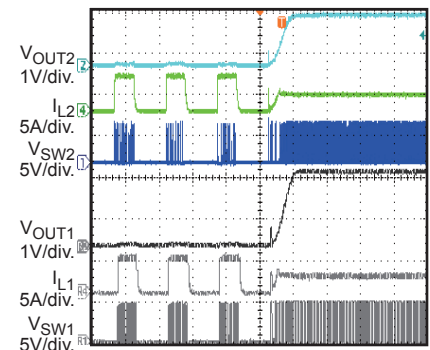

1ms/div

EVB TEST RESULTS

$V_{IN} = 5V$, $V_{OUT1} = 1.8V$, $V_{OUT2} = 1.2V$, $L1 = L2 = 1.5\mu H$, $F_{SW} = 2.25MHz$, $T_A = 25^\circ C$, unless otherwise noted.

SCP Recovery

$I_{OUT1}=3A$, $I_{OUT2}=1A$

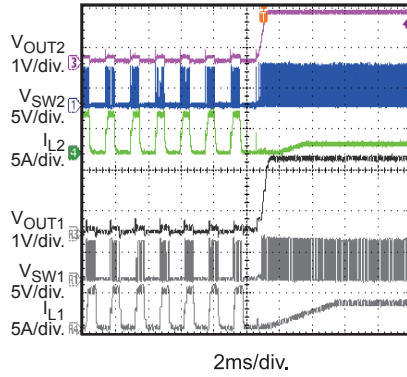

SCP Steady State

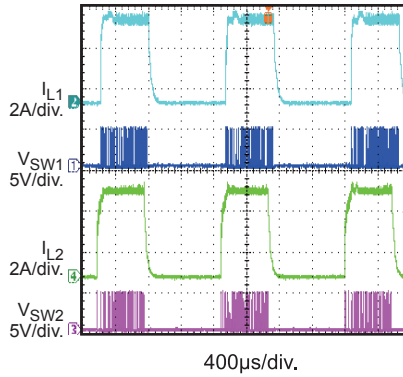

Load Transient

$I_{OUT1}=I_{OUT2}=0$ to 2A, AAM Mode, 1.6A/µS Speed

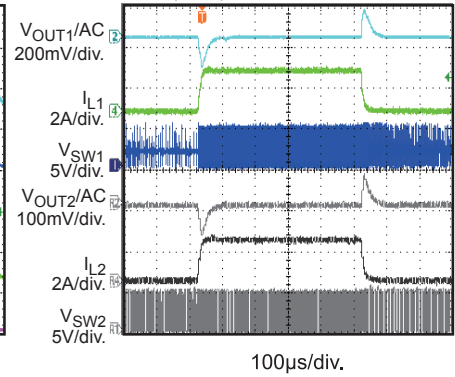

Load Transient

$I_{OUT1}=I_{OUT2}=1$ to 2A, AAM Mode, 1.6A/µS Speed

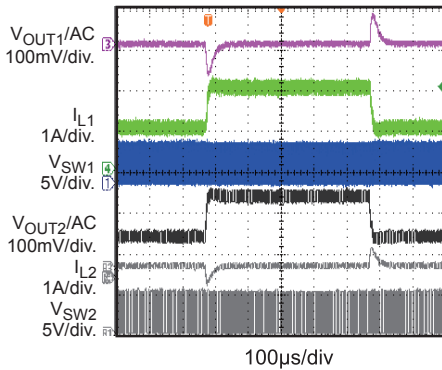

Load Transient

$I_{OUT1}=0$ to 3A, $I_{OUT2}=0$ to 1A, 1.6A/µS Speed

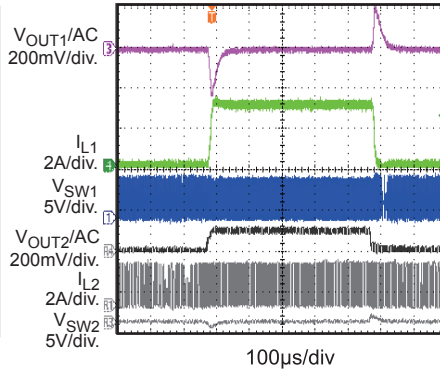

Load Transient

$I_{OUT1}=1.5$ to 3A, $I_{OUT2}=0.5$ to 1A, 1.6A/µS Speed

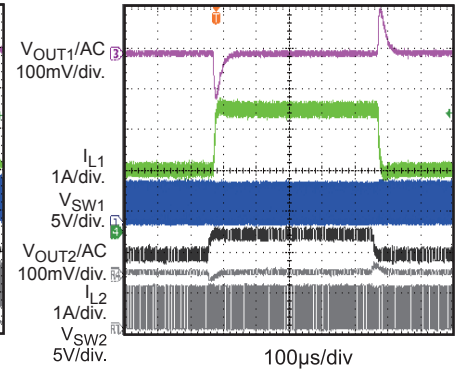

PRINTED CIRCUIT LAYOUT

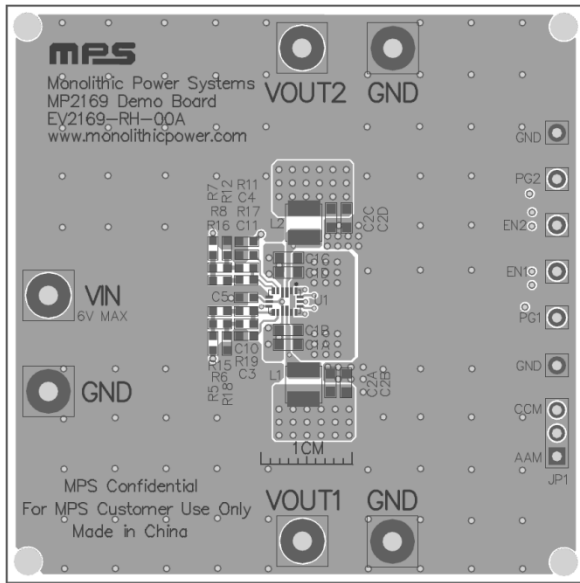

Top Silk & Top Layer

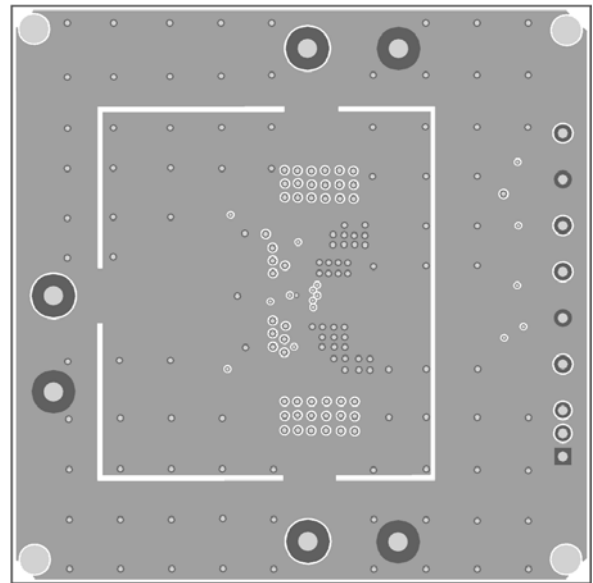

Inner1 Layer

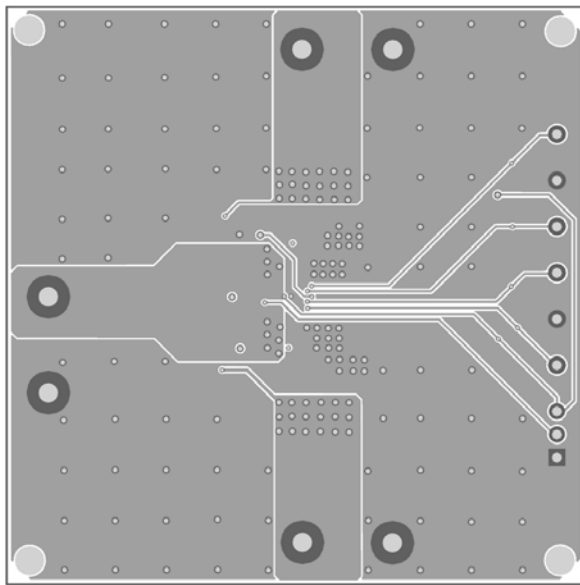

Inner2 Layer

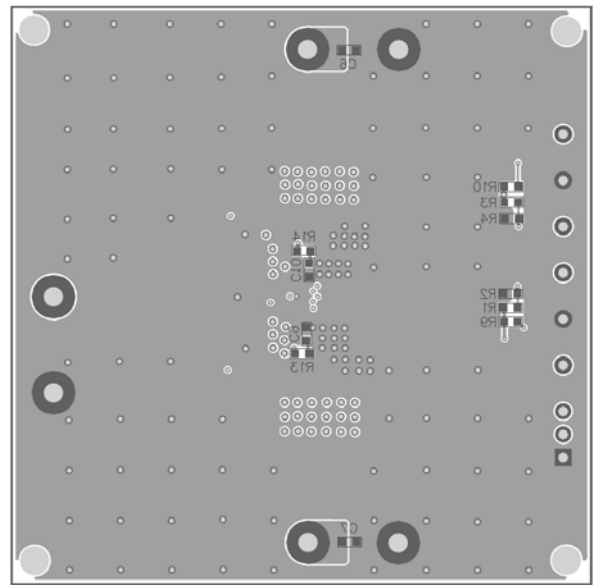

Bottom Silk & Bottom Layer

QUICK START GUIDE

1. Connect the positive and negative terminals of the load to the VOUT and GND pins, respectively. Be aware that electronic load represents negative impedance to the regulator and if set it to a too high current, the SCP protection may be triggered at startup.
2. Preset the power supply output to expected value (2.7V to 6V), and then turn it off.
3. Connect the positive and negative terminals of the power supply output to the VIN and GND pins, respectively.
4. Turn the power supply on, the MPQ2169 will automatically startup.
5. To use the Enable function, apply a digital input to the EN pin. Drive EN higher than 1.6V to turn on the regulator, drive EN less than 0.4V to turn it off.
6. The oscillating frequency of MPQ2169 can be programmed by an external frequency resistor R_{FREQ} . The relationship between the oscillator frequency and R_{FREQ} is shown in the schematic.
7. To use the Sync function, apply a 350kHz to 3MHz clock to the FREQ pin to synchronize the internal oscillator frequency to the external clock. The rising edge of the channel 1 clock is synchronized to the external clock rising edge, while the channel 2 clock remains at 180° out-of-phase to channel 1. Considering the parasitic capacitance of the pad, the pulse is recommended to be longer than 100ns.
8. Use JP1 to choose AAM/CCM mode at light load. Connecting the jumper to VCC to set the device to forced CCM mode; while connecting the jumper to GND to the set the device to AAM mode.
9. The output voltage is set by the external resistor divider. Choose 100 kΩ R_t to stable the loop. R_{UP} is estimated to be 100kΩ. R_{DOWN} can then be calculated with equation below:

$$R_{DOWN} = \frac{R_{UP}}{\frac{V_{OUT}}{0.6V} - 1}$$

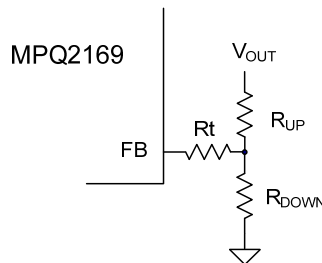

Below table lists the recommended feedback resistor values for common output voltages.

$V_{OUT}(V)$	$R_t(k\Omega)$	$R_{UP}(k\Omega)$	$R_{DOWN}(k\Omega)$
1.2	100	100	100
1.5	100	100	66.5
1.8	100	100	49.9
2.5	100	100	31.6
3.3	100	100	22.1

NOTICE: The information in this document is subject to change without notice. Users should warrant and guarantee that third party Intellectual Property rights are not infringed upon when integrating MPS products into any application. MPS will not assume any legal responsibility for any said applications.