

### DESCRIPTION

The EV2162A-QH-00A is used for demonstrating the performance of MPS's MP2162A, a low voltage high switching frequency step-down switcher with built in power MOSFETs. MP2162A provides up to 2A highly efficient output with constant-on-time control for fast loop response.

MP2162A is ideal for powering portable equipment that runs from a single cell Lithium-ion (Li+) Battery. The output voltage can be regulated as low as 0.6V.

High power efficiency over a wide load range is achieved by scaling down the switching frequency at light load to reduce the switching related loss by constant on time control. Short circuit and thermal shutdown provides reliable, fault-tolerant operation.

MP2162A is available in QFN8 (1.5mm × 2mm) package.

### ELECTRICAL SPECIFICATION

Parameter	Symbol	Value	Units
Input Voltage <sup>(1)</sup>	V <sub>IN</sub>	2.5– 6	V
Output Voltage	V <sub>OUT</sub>	1.2	V
Output Current	I <sub>OUT</sub>	2	A

Note: 1) More input capacitors may be needed when V<sub>IN</sub><3.6V.

### FEATURES

- Very Low I<sub>Q</sub>: 17µA
- Default 1.5MHz Switching Frequency
- 1.5% V<sub>FB</sub> Accuracy
- EN and Power Good for Power Sequencing
- Wide 2.5V to 6V Operating Input Range Output Adjustable from 0.6V
- Up to 2A Output Current
- 100% Duty Cycle in Dropout
- 110mΩ and 60mΩ Internal Power MOSFET Switches
- Cycle-by-Cycle Over Current Protection
- Short Circuit Protect with Hiccup Mode
- Stable with Low ESR Output Ceramic Capacitors
- Available in a QFN8 (1.5mm × 2mm) Package

### APPLICATIONS

- Wireless/Networking Cards
- Portable Instruments
- Battery Powered Devices
- Low Voltage I/O System Power

All MPS parts are lead-free, halogen free, and adhere to the RoHS directive. For MPS green status, please visit MPS website under Quality Assurance. "MPS" and "The Future of Analog IC Technology" are Registered Trademarks of Monolithic Power Systems, Inc.

### EV2162A-QH-00A EVALUATION BOARD



Board Number	MPS IC Number
EV2162A-QH-00A	MP2162AGQH

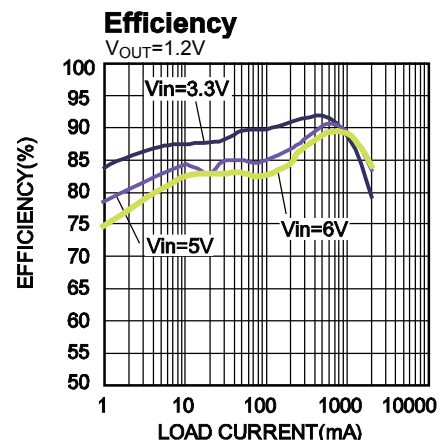

## EVALUATION BOARD SCHEMATIC

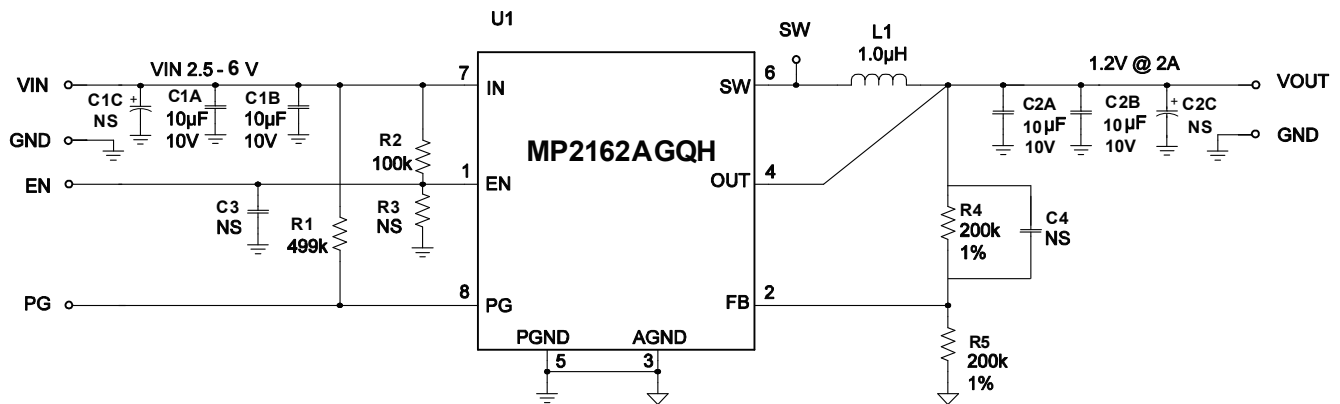

## EV2162A-QH-00A BILL OF MATERIALS

Qty	RefDes	Value	Description	Package	Manufacturer	Manufacturer P/N
2	C1A, C1B	10µF	Ceramic Cap., 10V, X5R	SM0805	TDK	C2012X5R1A106K
2	C2A, C2B	10µF	Ceramic Cap., 10V, X5R	SM0805	TDK	C2012X5R1A106K
0	C1C, C2C	NS				
0	C3, C4	NS				
1	R1	499kΩ	Film Res., 5%	SM0603	Any	
1	R2	100kΩ	Film Res., 5%	SM0603	Any	
0	R3	NS				
1	R4	200kΩ	Film Res., 1%	SM0603	Yageo	RC0603FR-07200KL
1	R5	200kΩ	Film Res., 1%	SM0603	Yageo	RC0603FR-07200KL
1	L1	1µH	Inductor, 6.84A	SMD	Würth	744777001
1	U1		COT Buck	QFN8 (1.5mm×2mm)	MPS	MP2162AGQH

## EVB TEST RESULTS

Performance waveforms are tested on the evaluation board.

$V_{IN} = 5V$ ,  $V_{OUT} = 1.2V$ ,  $L = 1.0\mu H$ ,  $T_A = +25^\circ C$ , unless otherwise noted.

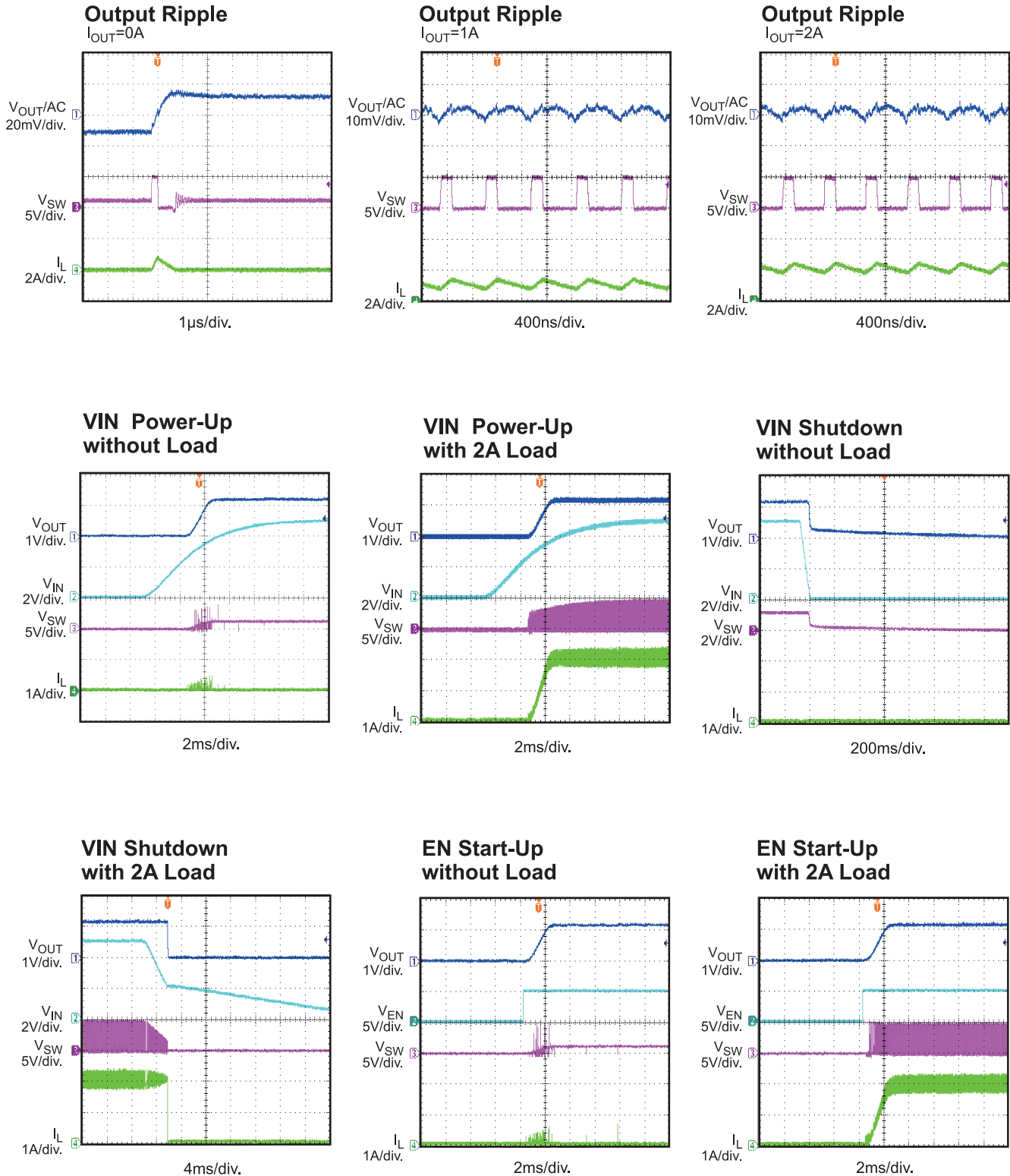

**EVB TEST RESULTS** *(continued)*

Performance waveforms are tested on the evaluation board.

$V_{IN} = 5V$ ,  $V_{OUT} = 1.2V$ ,  $L = 1.0\mu H$ ,  $T_A = +25^\circ C$ , unless otherwise noted.

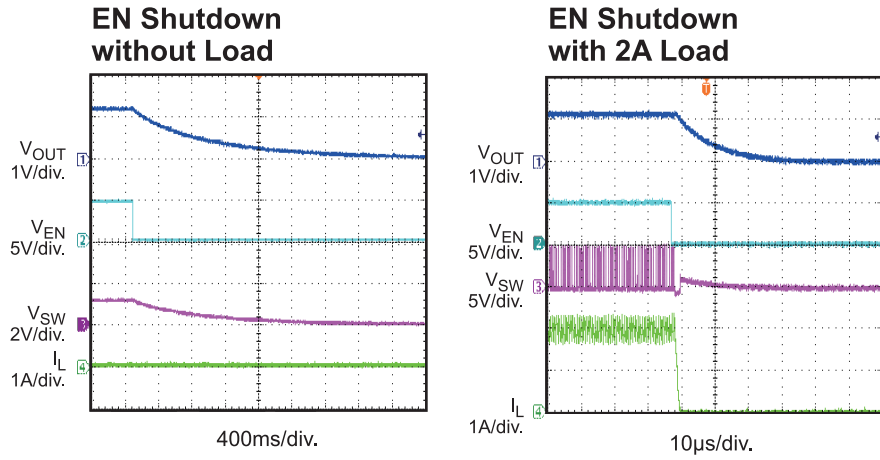

## PRINTED CIRCUIT BOARD LAYOUT

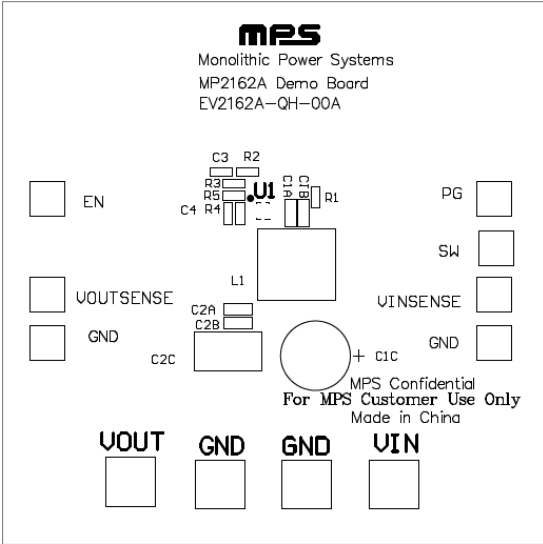

Figure 1: Top Silk Layer

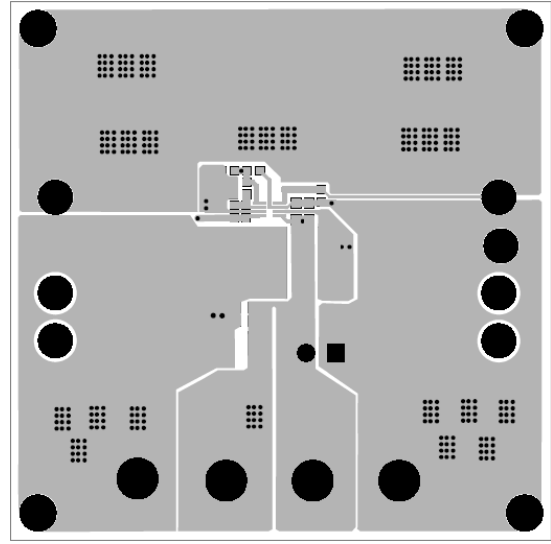

Figure 2: Top Layer

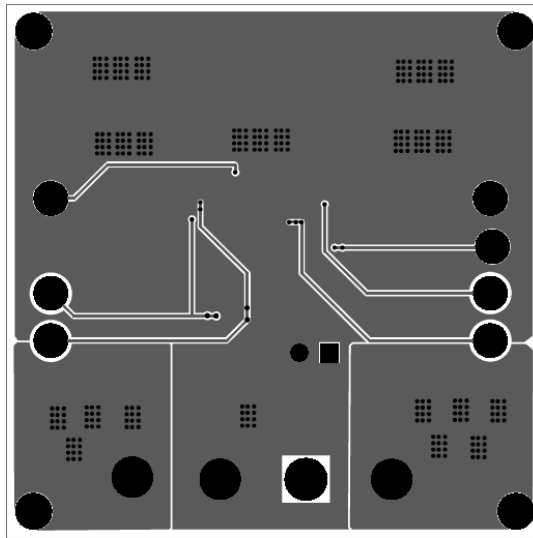

Figure 3: Bottom Layer

## QUICK START GUIDE

1. Connect the positive and negative terminals of the load to the VOUT and GND pins, respectively.
2. Preset the power supply output between 2.5V and 6V, and then turn off the power supply.
3. Connect the positive and negative terminals of the power supply output to the VIN and GND pins, respectively.
4. Turn the power supply on. The board will automatically start up.
5. To use the enable function, apply a digital input to the EN pin. Drive EN higher than 1.2V to turn on the regulator or less than 0.4V to turn it off.

## LAYOUT RECOMMENDATION OF MP2162A

Proper layout of the switching power supplies is very important, and sometimes critical to make it work properly. Especially, for the high switching converter, if the layout is not carefully done, the regulator could show poor line or load regulation, stability issues.

For MP2162A, the high speed step-down regulator, the input capacitor should be placed as close as possible to the IC pins. As shown in Figure 4, the 0805 size ceramic capacitors (C1A and C1B) are used, please make sure the two ends of the ceramic capacitor be directly connected to PIN7 (the Power Input Pin) and PIN5 (the Power GND Pin).

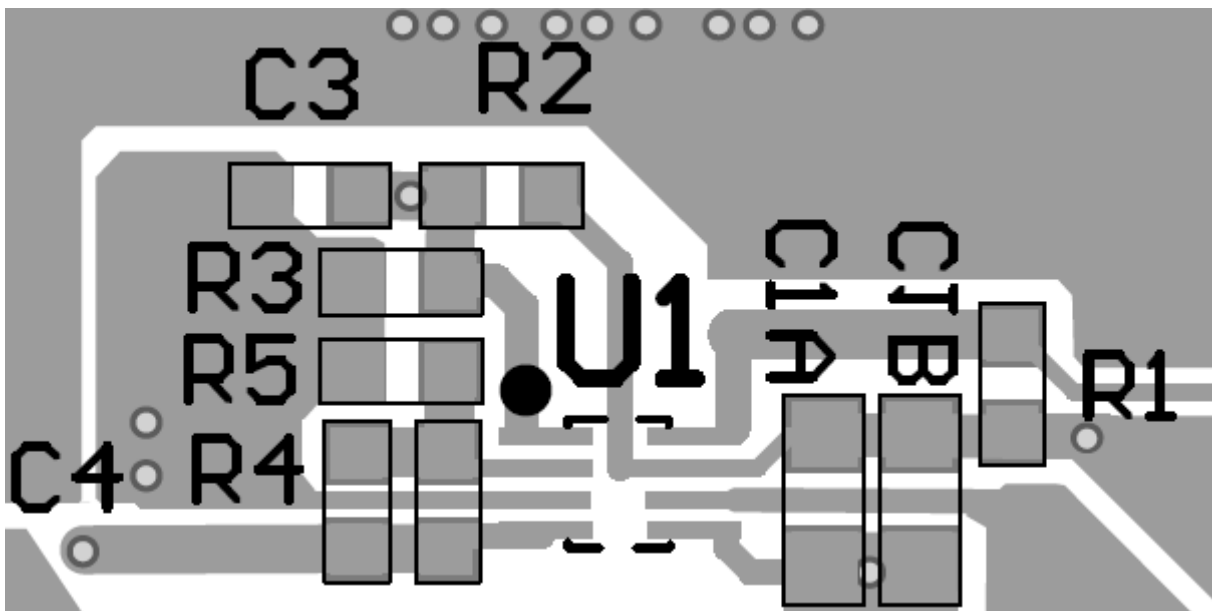

Figure 4: Two ends of Input decoupling Capacitor close to Pin 7 and Pin 5

**NOTICE:** The information in this document is subject to change without notice. Please contact MPS for current specifications. Users should warrant and guarantee that third party Intellectual Property rights are not infringed upon when integrating MPS products into any application. MPS will not assume any legal responsibility for any said applications.