



EV174A-S-00A

Universal Input,
Non-Isolated Off-Line Regulator
With Improved EMI Performance
Evaluation Board

DESCRIPTION

The EV174A-S-00A Evaluation Board is designed to demonstrate the capabilities of MP174A. The MP174A is a primary-side constant voltage regulator, which provides accurate constant voltage (CV) regulation without Opto-coupler. It supports Buck, Buck-Boost, Boost and Flyback topologies.

The EV174A-S-00A Evaluation Board is designed as Buck application. EV174A-S-00A typically outputs 3.6W with a 12V/300mA load from 85VAC to 265VAC input.

The EV174A-S-00A has excellent efficiency and meets IEC61000-4-5 surge immunity and EN55022 conducted EMI requirements. Most of all, the radiation performance gets improved compared with MP174. MP174A features various protections, including thermal shutdown (TSD), VCC under-voltage lockout (UVLO), over-load protection (OLP), short-circuit protection (SCP), and open loop protection.

MP174AGS is available in SOIC8 package.

ELECTRICAL SPECIFICATION

Parameter	Symbol	Value	Units
Input Voltage	V_{IN}	85 to 265	VAC
Output Voltage	V_{OUT}	12	V
Output Current	I_{OUT}	0.3	A
Output Power	P_{OUT}	3.6	W
Efficiency (full load)	η	>75	%

FEATURES

- Primary-Side non-isolated Constant Voltage (CV) Control
- < 30mW No-load power consumption
- Up to 3.6W output power
- Good EMI Performance
- Limited Maximum Frequency
- Multiple Protections: SCP, OCP, OTP, OLD and VCC UVLO
- Low Cost and Simple External circuit

APPLICATIONS

- Home Appliance, white goods and consumer electronics
- Industrial Controls
- Standby Power

All MPS parts are lead-free, halogen free, and adhere to the RoHS directive. For MPS green status, please visit MPS website under Quality Assurance. "MPS" and "The Future of Analog IC Technology" are Registered Trademarks of Monolithic Power Systems, Inc.



High Voltage

Warning: Although this board is designed to satisfy safety requirements, the engineering prototype has not been agency approved. Therefore, all testing should be performed using an isolation transformer to provide the AC input to the prototype board.

EV174A-S-00A EVALUATION BOARD

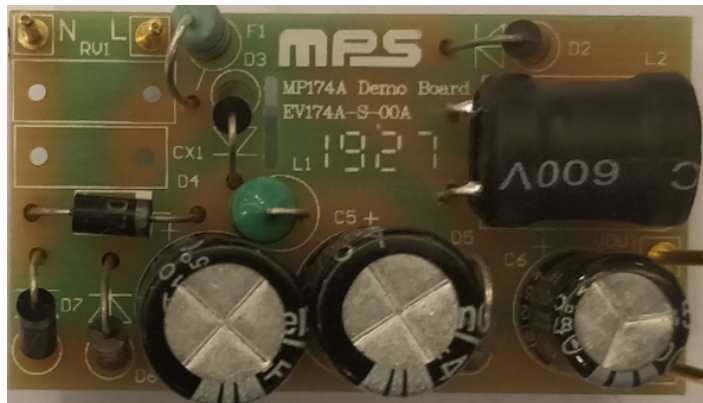

TOP VIEW



BOTTOM VIEW

(L x W x H) 68mm x 28mm x 17mm

Board Number	MPS IC Number
EV174A-S-00A	MP174AGS

PCB LAYOUT (SINGLE-SIDED)

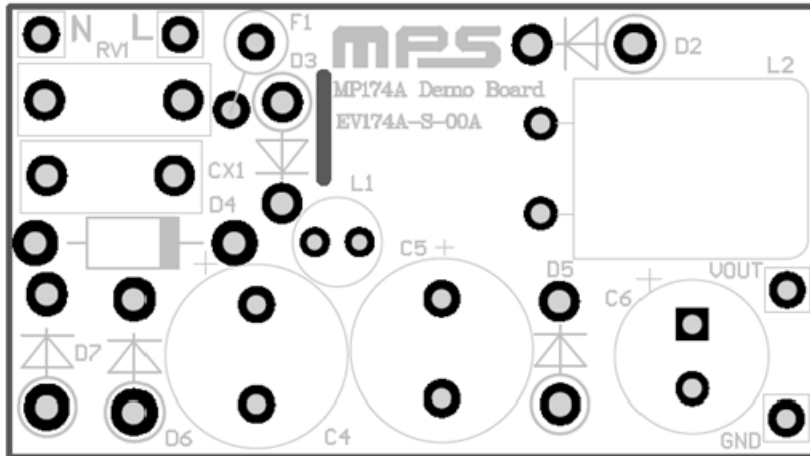

Figure 2: Top Layer

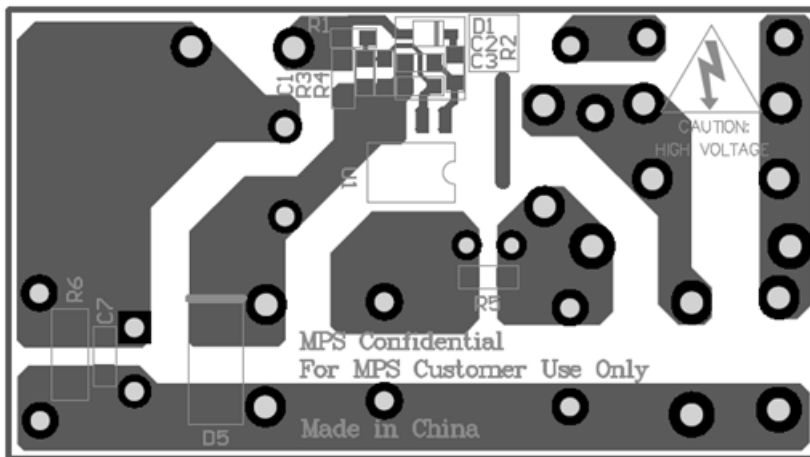

Figure 3: Bottom Layer

EV174A-S-00A BILL OF MATERIALS

Qty	Ref	Value	Description	Package	Manufacture	Manufacture_PN
1	C1	470nF	Ceramic Capacitor;50V;X7R	0603	TDK	C1608X7R1H474K
1	C2	2.2μF	Ceramic Capacitor;10V;X7R	0603	muRata	GRM188R71A225KE15D
1	C3	1nF	Ceramic Capacitor;50V;X7R	0603	muRata	GRM188R71H102KA01D
2	C4, C5	10μF	Electrolytic Capacitor;400V;20%	DIP	Any	Any
1	C6	100μF	Electrolytic Capacitor;35V	DIP	Jianghai	CD287-35V100
1	C7	1μF	Ceramic Capacitor;16V;X7R	0603	muRata	GRM188R71C105KA12D
1	D1	1N4148WS	Diode;75V;0.15A	SOD-323	Diodes	1N4148WS-7-F
5	D2, D3, D4, D6, D7	1N4007	Diode;1000V;1A	DO-41	Diodes	1N4007
1	D5	STTH1R06	Diode;600V;1A	DO-41	ST	STTH1R06
1	F1	10Ω	Resistor;5%;1W	DIP	Yageo	FKN1WSJT-52-10R
1	L1	1mH	Inductor;1000uH;8Ω;0.1A	DIP	Any	Any
1	L2	1.2mH	Inductor;1.2mH;1.8Ω;400mA	DIP	Emei	DR9X12P2M1.2-00
1	R1	19.1kΩ	Film Resistor;1%	0603	Yageo	RC0603FR-0719K1L
1	R2	20kΩ	Film Resistor;1%	0603	Yageo	RC0603FR-0720KL
1	R4	4.99kΩ	Film Resistor;1%	0603	Yageo	RC0603FR-074K99L
1	R6	20kΩ	Film Resistor;1%	1206	Yageo	RC1206JR-0720KL
1	U1	MP174A	Primary side regulator	SOIC8	MPS	MP174AGS

CIRCUIT DESCRIPTION

The EV174A-S-00A is configured in a buck regulator topology, it uses primary-side-control which can mostly simplify the schematic and get a cost-effective BOM. It can also achieve accurate constant voltage and acceptable cross regulation.

F1 is used to protect circuit from component failure or some excessive short events. Also, it can restrain the inrush current.

C4, L1 and C5 compose π filter to guarantee the conducted EMI meet standard EN55022. C2 and C3 are also used for energy storage and protecting against line surge.

R2, C2, and D1 are used as VCC power supply. Though MP174A is equipped with an internal high voltage current source, using this circuit can achieve better efficiency.

C1 is the sample-hold capacitor, used for reflecting output voltage. R1 and R4 are resistor divider for detecting output voltage by sampling voltage on C1.

D5 is the freewheeling diode. For universal voltage applications, use a diode with a 600V reverse block voltage. Ultra-fast recovery diode is recommended for better efficiency.

C6 and C7 are output capacitors for 12V output. C6 should be low ESR electrolytic capacitor for better output ripple. C7 is ceramic capacitor to reduce high frequency voltage ripple. R6 is dummy load to lower the output voltage of 12V rail at no load condition.

Surge Performance

Line to Line 1kV surge tested according to IEC61000-4-5.

Input voltage was set at 230VAC/50Hz. Output was loaded at full load and operation was verified successful under following surge event.

Surge Level (V)	Input Voltage (VAC)	Injection Location	Injection Phase (°)	Test Result (Pass/Fail)
1000	230	L to N	0	Pass
1000	230	L to N	90	Pass
1000	230	L to N	180	Pass
1000	230	L to N	270	Pass
-1000	230	L to N	0	Pass
-1000	230	L to N	90	Pass
-1000	230	L to N	180	Pass
-1000	230	L to N	270	Pass

The board can pass 2kV surge test by simply using two 10ohm/1W fuse resistors, as the circuit shows below.

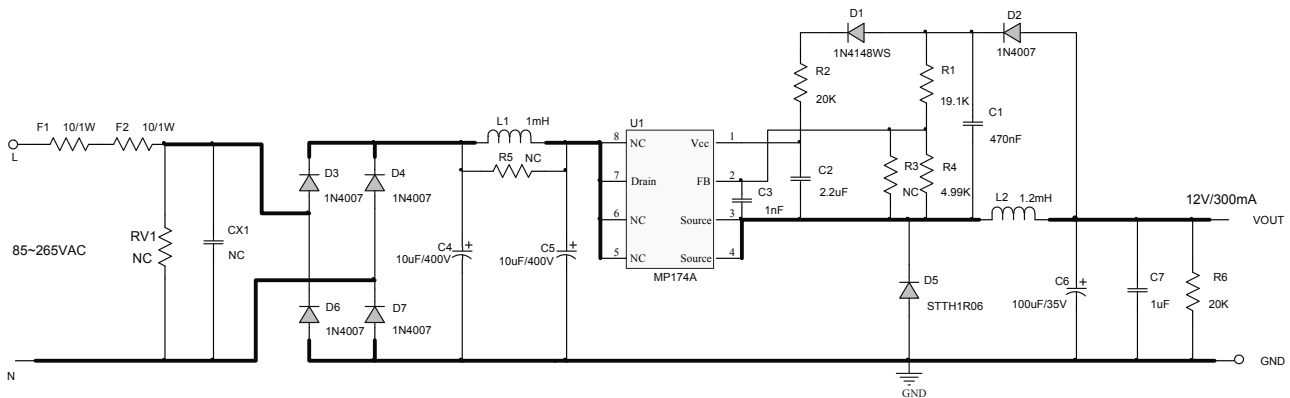

Figure 4: Reference schematic for 2kV surge

EVB TEST RESULTS

Performance waveforms are tested on the evaluation board.

$V_{IN}=230V_{AC}$, $V_{OUT}=12V$, $I_{OUT}=0.3A$, $T_A=26^{\circ}C$, unless otherwise noted.

Thermal

$V_{IN}=85V_{AC}$, $F_S=24.8kHz$

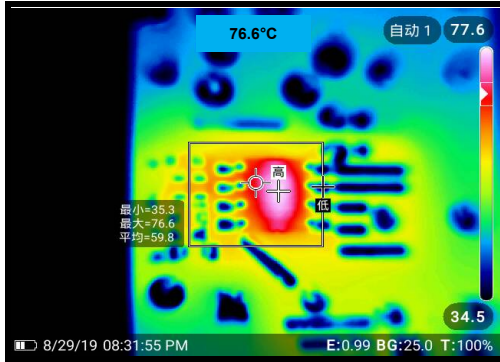

Thermal

$V_{IN}=265V_{AC}$, $F_S=26.5kHz$

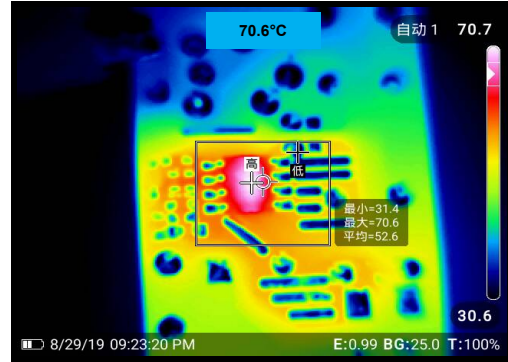

No Load Consumption

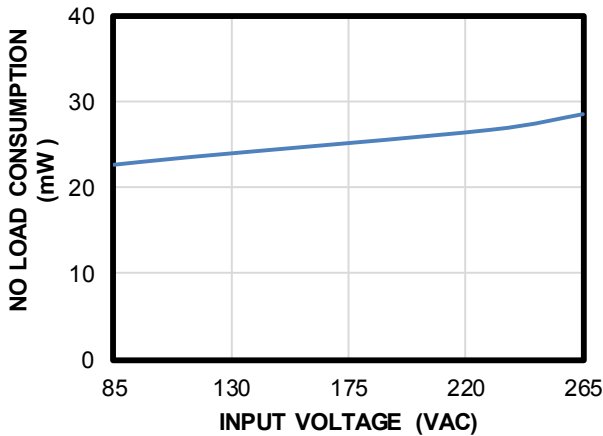

Efficiency

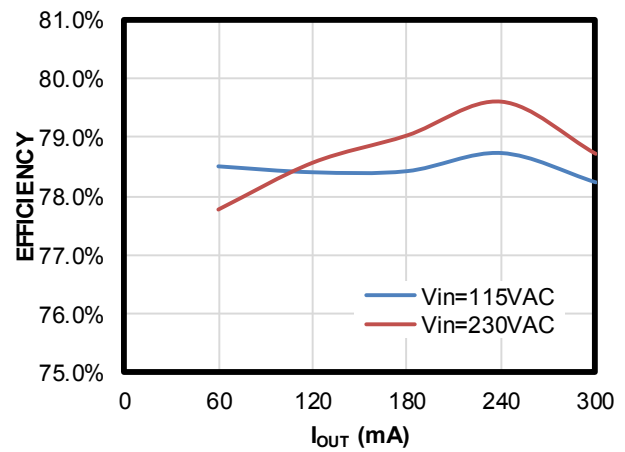

Load Regulation

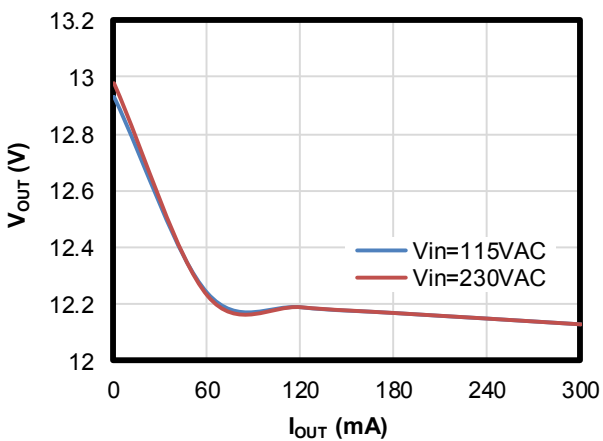

RE Performance

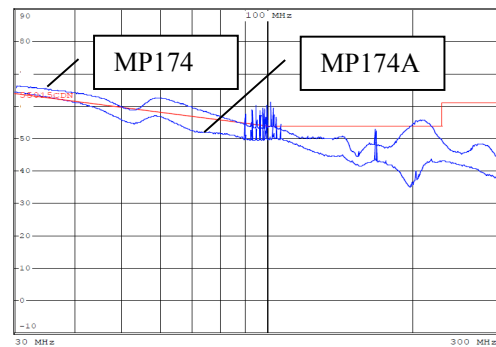

EVB TEST RESULTS *(continued)*

Performance waveforms are tested on the evaluation board.

$V_{IN}=230V_{AC}$, $V_{OUT}=12V$, $I_{OUT}=0.3A$, $T_A=26^{\circ}C$, unless otherwise noted.

CE Performance-L Line

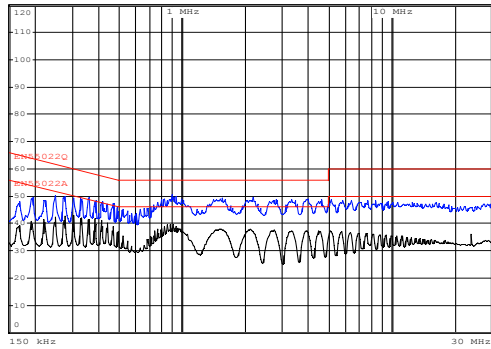

CE Performance-N Line

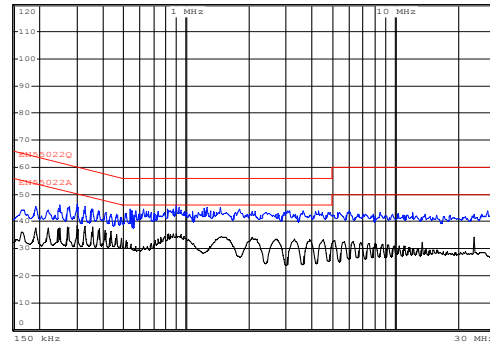

EVB TEST RESULTS *(continued)*

Performance waveforms are tested on the evaluation board.

$V_{IN}=230V_{AC}$, $V_{OUT}=12V$, $I_{OUT}=0.3A$, $T_A=26^{\circ}C$, unless otherwise noted.

Steady State

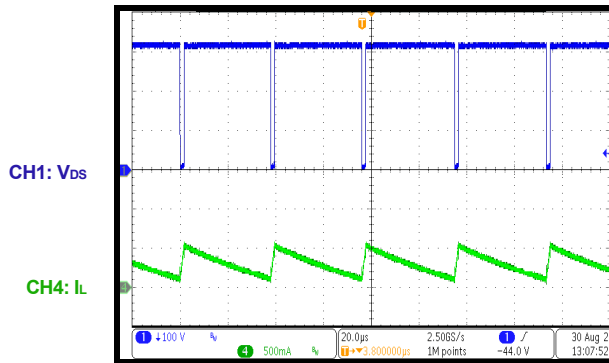

Output Ripple

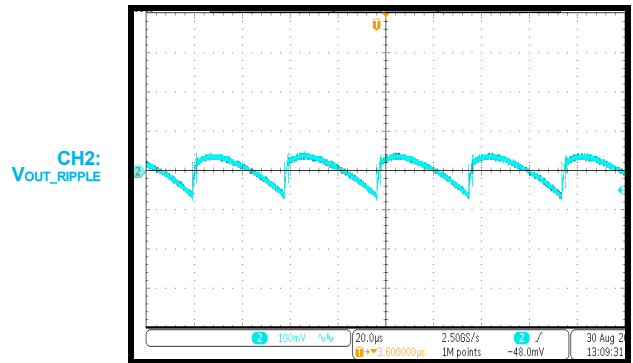

Start-Up

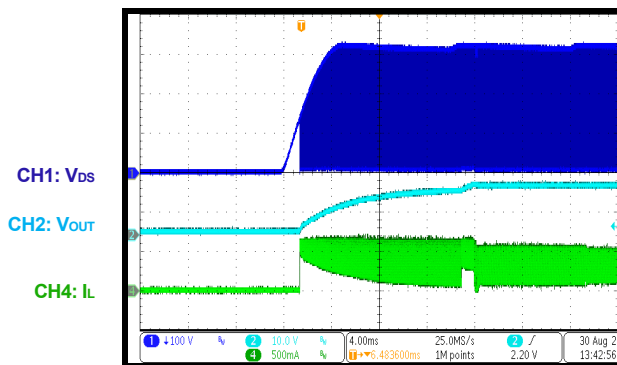

Start-Up

$V_{IN}=265V_{AC}$, $L=680\mu H$, $C_{OUT}=1000\mu F$

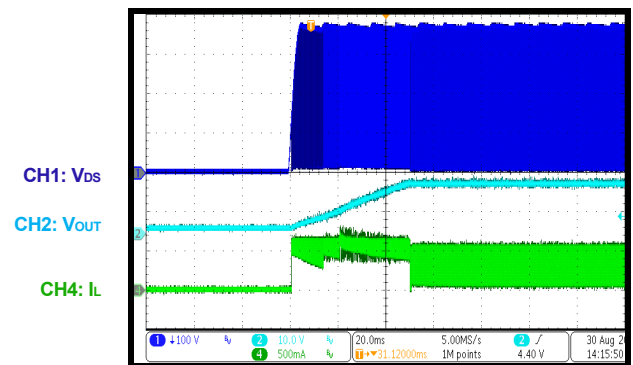

Load Transient

25%-50% Load

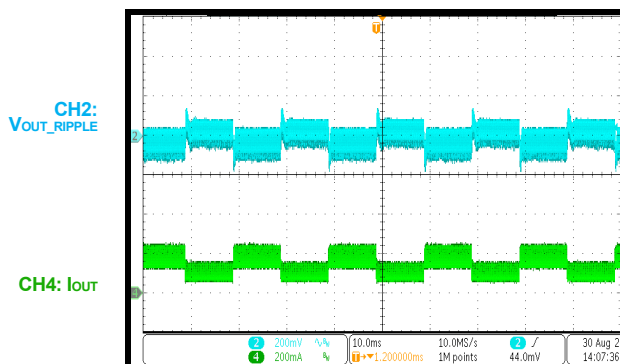

Load Transient

50%-75% Load

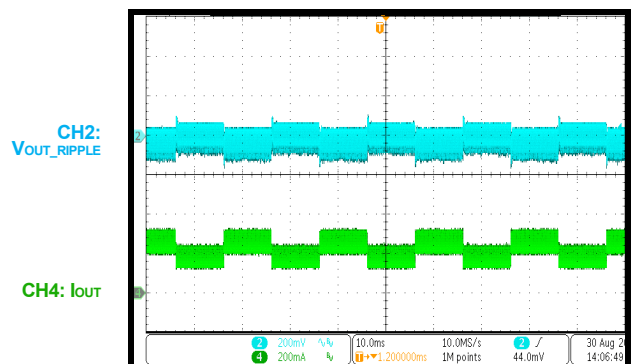

EVB TEST RESULTS *(continued)*

Performance waveforms are tested on the evaluation board.

$V_{IN}=230V_{AC}$, $V_{OUT}=12V$, $I_{OUT}=0.3A$, $T_A=26^{\circ}C$, unless otherwise noted.

SCP Entry and Recovery

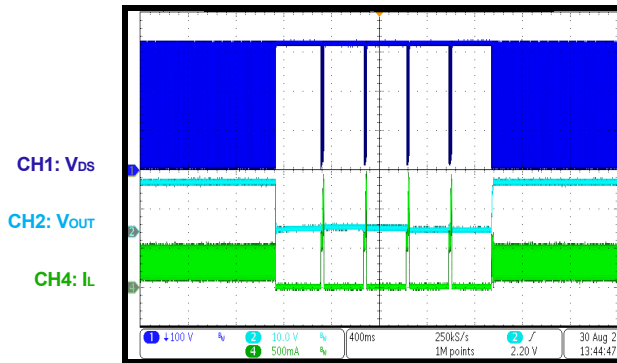

OLP Entry and Recovery

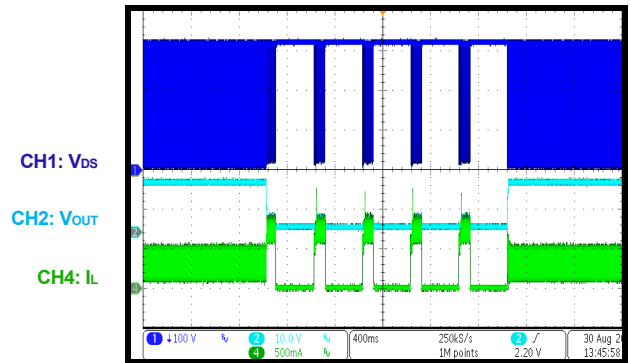

Open Loop Entry and Recovery

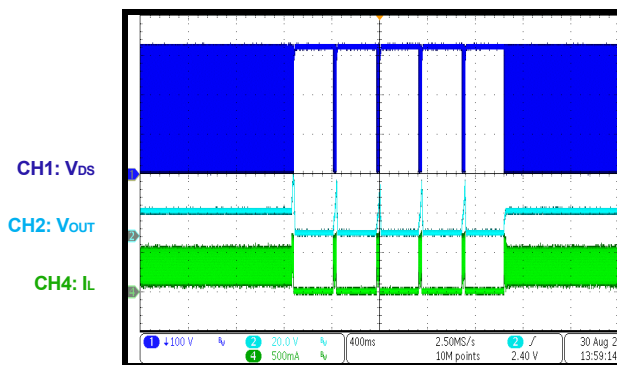

OTP Entry and Recovery

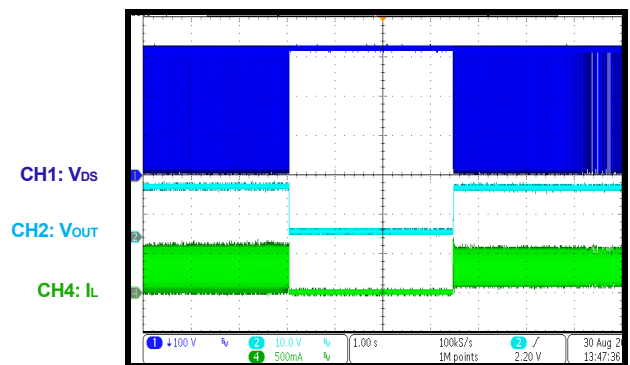

QUICK START GUIDE

1. Preset Power Supply to $85\text{VAC} \leq V_{\text{IN}} \leq 265\text{VAC}$.
2. Turn Power Supply off.
3. Connect the Line and Neutral terminals of the power supply output to L and N port.
4. Connect Different Load to Corresponding Outputs:
 - a. Positive (+): 12V OUT
 - b. Negative (-): GND
5. Turn Power Supply on after making connections.

NOTICE: The information in this document is subject to change without notice. Please contact MPS for current specifications. Users should warrant and guarantee that third party Intellectual Property rights are not infringed upon when integrating MPS products into any application. MPS will not assume any legal responsibility for any said applications.