

DESCRIPTION

The MP1606 is a monolithic, step-down, switch-mode converter with built-in internal power MOSFETs. It achieves 2A continuous output current from a 2.5V-to-5.5V input voltage with excellent load and line regulation. MP1606 provides different fixed output voltage with PG function.

The Constant-On-Time control scheme provides fast transient response and eases loop stabilization. Fault protections include cycle-by-cycle current limiting and thermal shutdown.

The MP1606 is available in an ultra-small SOT563 package and requires a minimal number of readily available standard external components.

The MP1606 is ideal for a wide range of applications including high performance DSPs, wireless power, portable and mobile devices, and other low-power systems.

ELECTRICAL SPECIFICATION

Parameter	Symbol	Value	Units
Input Voltage	V_{IN}	2.5 – 5.5	V
Output Voltage	V_{OUT}	1.2	V
Output Current	I_{OUT}	2	A

Note: $V_{IN} < 3.3V$ may need more input capacitor.

FEATURES

- Low I_Q : 27µA
- 1.1MHz Switching Frequency
- EN for Power Sequencing
- 1% Output Voltage Accuracy
- Wide 2.5V-to-5.5V Operating Input Range
- V_{OUT} : 0.8/0.9/1.0/1.2/1.35/2.0/2.85/3.2V
- Power Good
- Up to 2A Output Current
- 75mΩ and 45mΩ Internal Power MOSFET Switches
- 100% Duty On
- Output Discharge
- V_O OVP
- Short-Circuit Protection with Hiccup Mode
- Available in a SOT563 Package

APPLICATIONS

- Wireless/Networking Cards
- Solid State Drives (SSD)
- Battery Powered Devices
- Low Voltage I/O System Power
- Multi Function Printer

All MPS parts are lead-free, halogen free, and adhere to the RoHS directive. For MPS green status, please visit MPS website under Quality Assurance.

"MPS" and "The Future of Analog IC Technology" are Registered Trademarks of Monolithic Power Systems, Inc.

EV1606-TF-00A EVALUATION BOARD

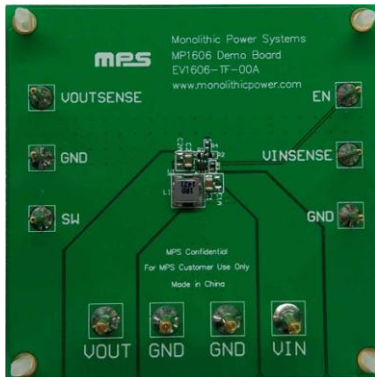

Board Number	MPS IC Number
EV1606-TF-00A	MP1606GTF

Efficiency vs. Output Current

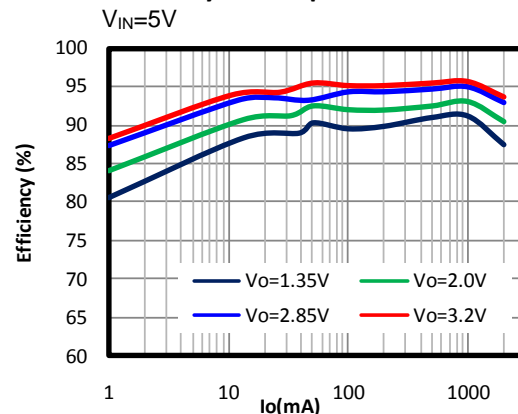

EVALUATION BOARD SCHEMATIC

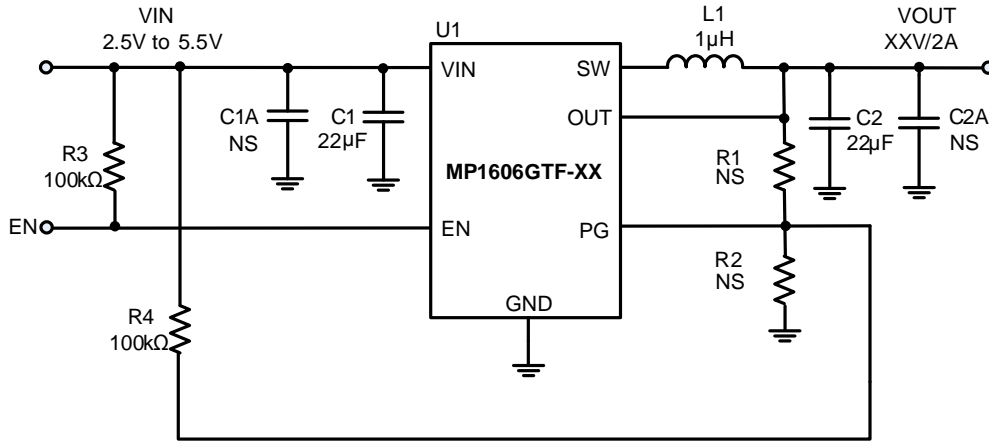

Figure 1—Typical Application Circuit for MP1606GTF-XX

Note: 1. $V_{IN} < 3.3V$ may need more input capacitor;
 2. $V_{IN} > V_{OUT}$ for application.

EV1606-TF-00A BILL OF MATERIALS

Qty	RefDes	Value	Description	Package	Manufacturer	Manufacturer P/N
2	C1, C2	22 μ F	Ceramic Cap,10V,X5R	0805	muRata	GRM21BR61A226ME51L
2	R3, R4	100k	Film Res.1%	0402	any	
1	L1	1.0 μ H	Inductor,I _s =9A, DCR=27m Ω	SMD	Würth	74437324010
1	U1		Step-down Switcher	SOT563	MPS	MP1606GTF-XX
0	C1A, C2A R1, R2	NS				

EVB TEST RESULTS

Performance waveforms are tested on the evaluation board.

V_{IN} = 5V, V_{OUT} = 1.2V, L = 1.0 μ H, C_{OUT}=22 μ F, T_A = +25 $^{\circ}$ C, unless otherwise noted.

Steady State

I_{OUT}=0A

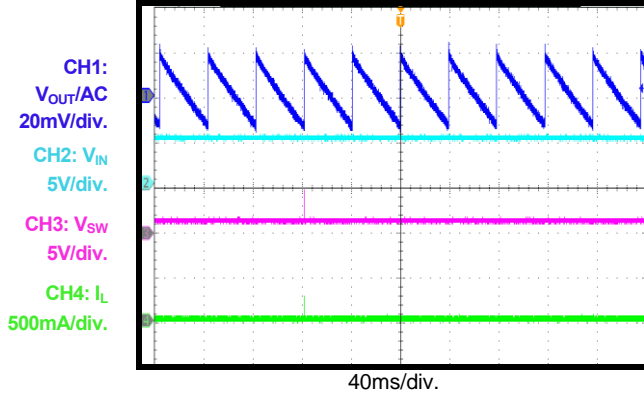

Steady State

I_{OUT}=2A

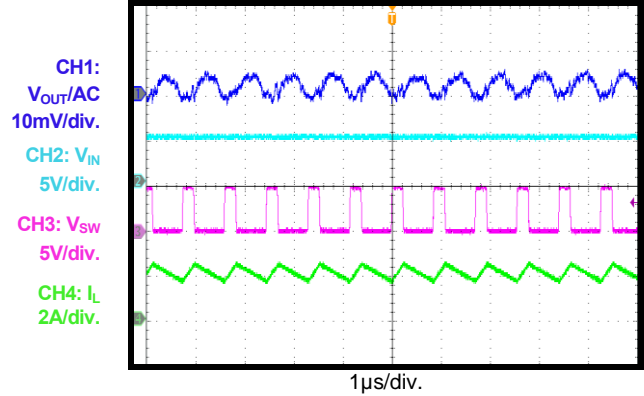

V_{IN} Power-Up

I_{OUT}=0A

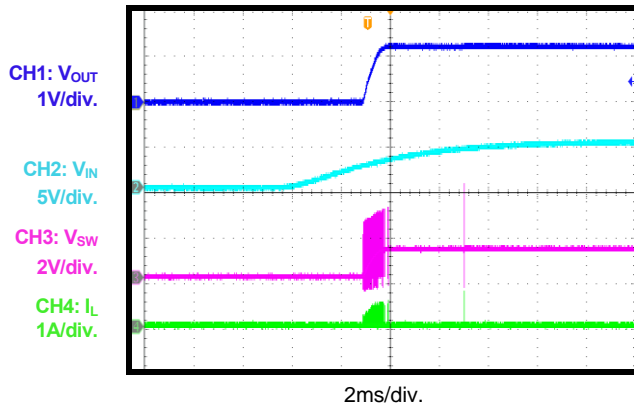

V_{IN} Power-Up

I_{OUT}=2A

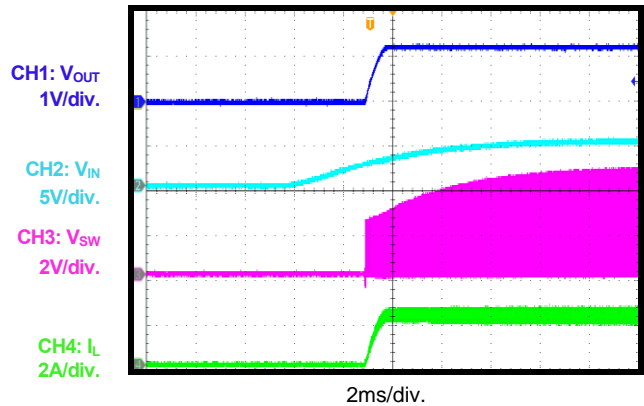

V_{IN} Shutdown

I_{OUT}=0A

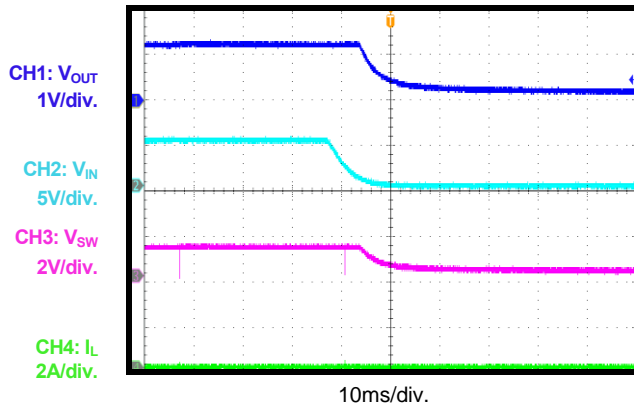

V_{IN} Shutdown

I_{OUT}=2A

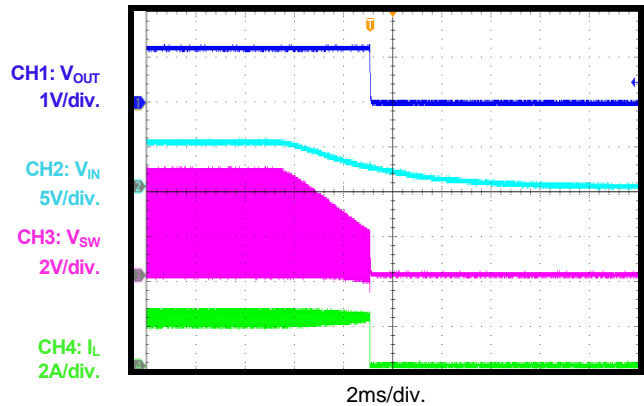

EVB TEST RESULTS *(continued)*

Performance waveforms are tested on the evaluation board.

V_{IN} = 5V, V_{OUT} = 1.2V, L = 1.0 μ H, C_{OUT} = 22 μ F, T_A = +25 $^{\circ}$ C, unless otherwise noted.

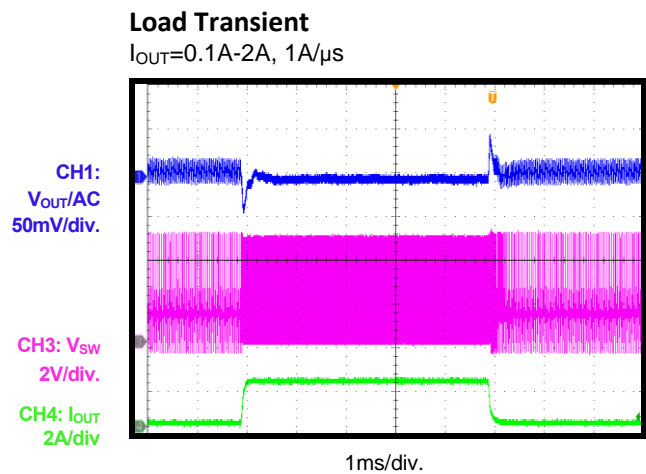
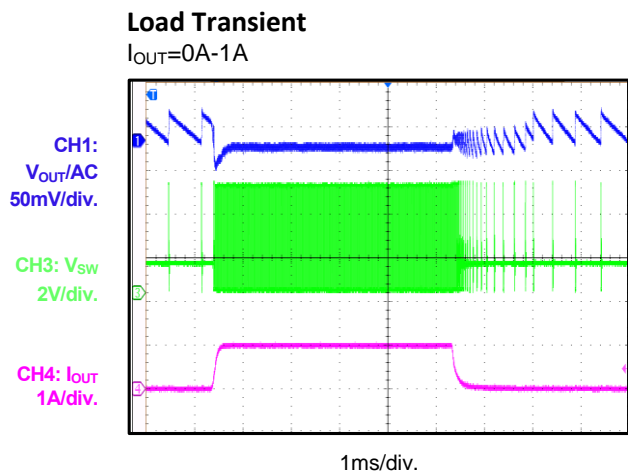
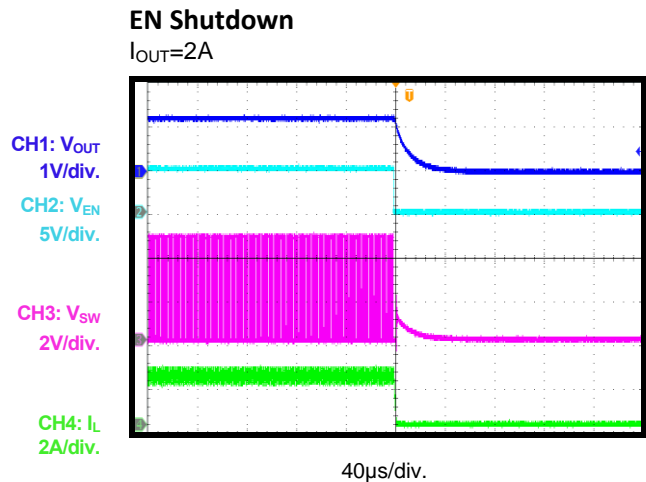
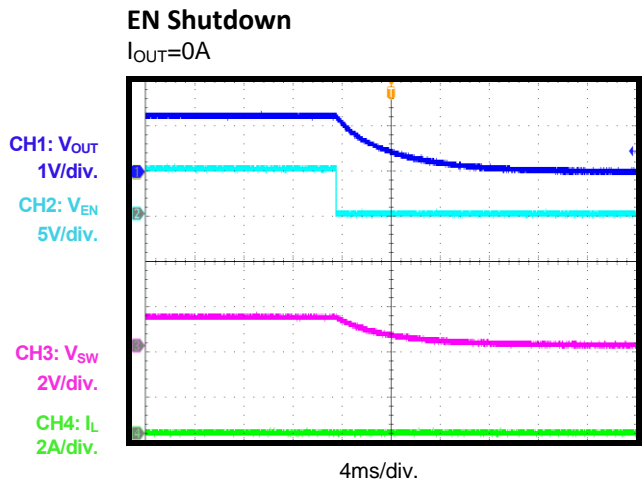
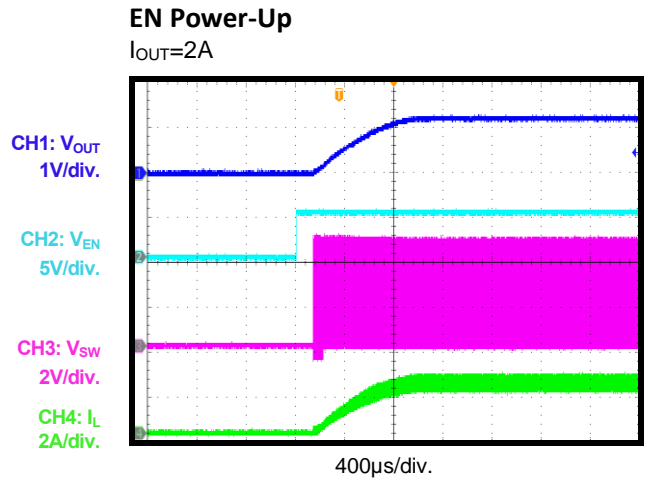
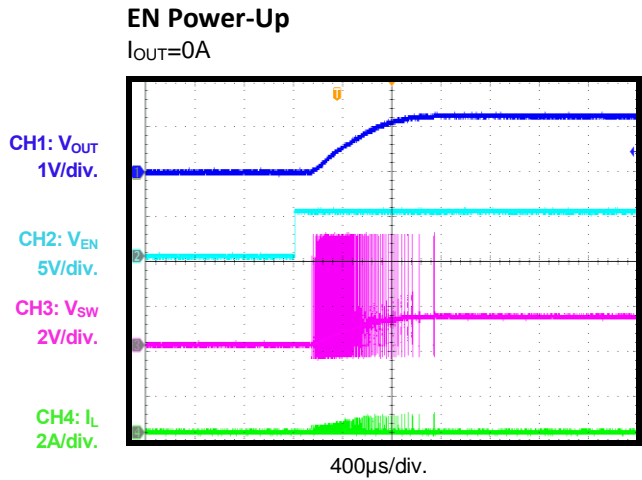

EVB TEST RESULTS (continued)

Performance waveforms are tested on the evaluation board.

V_{IN} = 5V, V_{OUT} = 1.2V, L = 1.0 μ H, C_{OUT} = 22 μ F, T_A = +25°C, unless otherwise noted.

Short-Circuit Entry

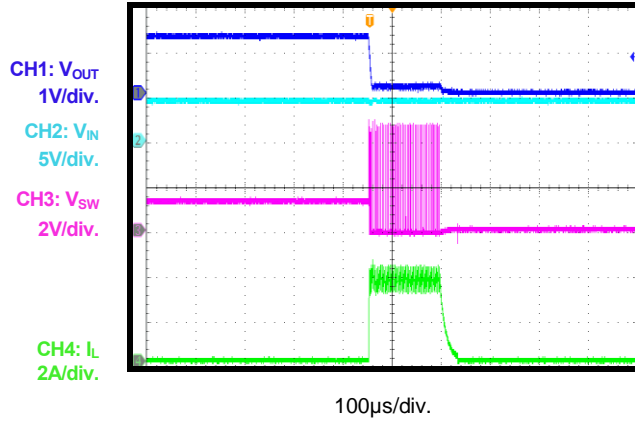

Short-Circuit State

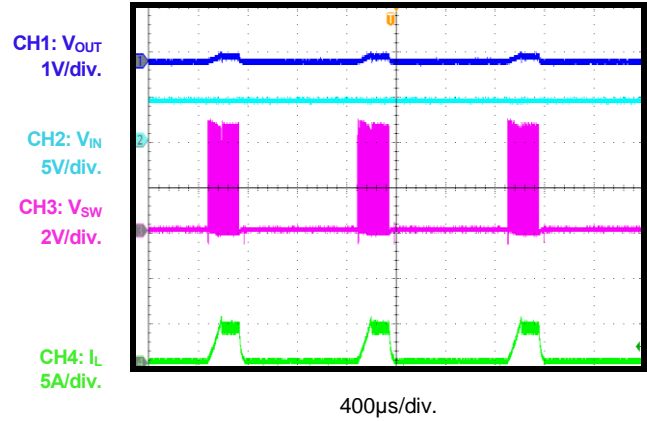

Short-Circuit Recovery

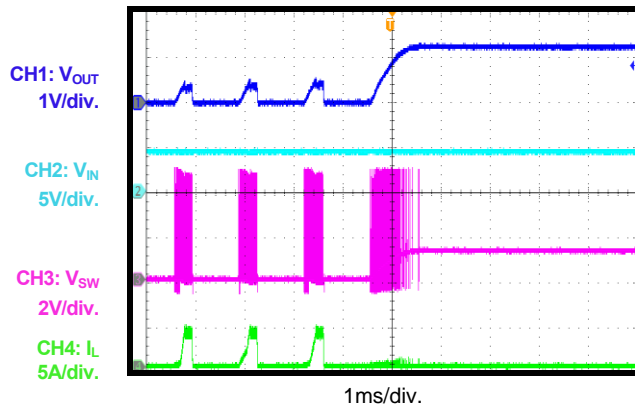

CIRCUIT BOARD LAYOUT

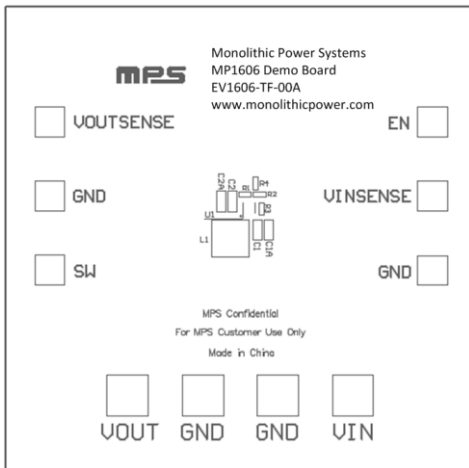

Figure 2—Top Silk Layer

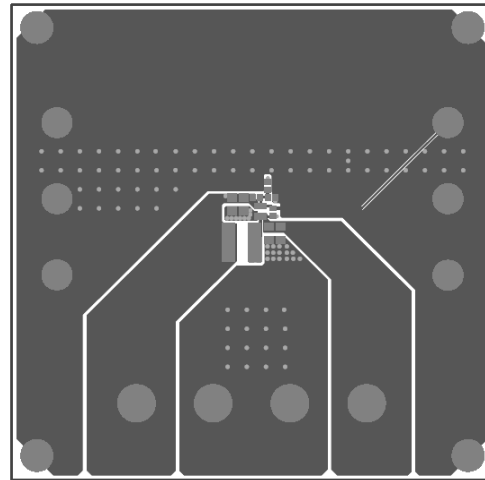

Figure 3—Top Layer

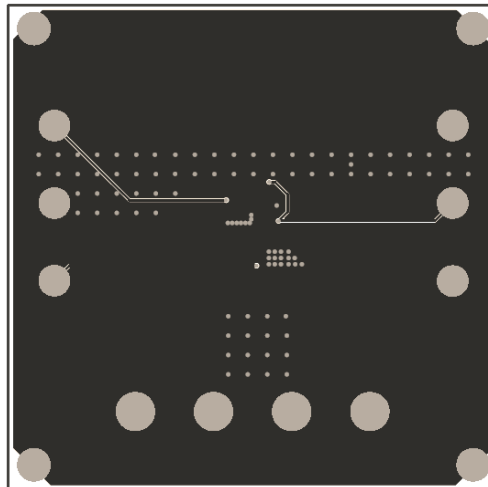

Figure 4—Bottom Layer

QUICK START GUIDE(MP1606GTF-XX)

Refer to Figure1 to set up fixed version. R1 and R2 must be removed. R4 connects PG pin and pulls up to Vin. MP1606GTF-12(-08, -09, -10, -135, -20, -285,-32) board provide corresponding fixed output voltage with PG function.

1. Connect the positive and negative terminals of the load to the VOUT and GND pins, respectively.
2. Preset the power supply output between 2.5V and 5.5V, and then turn off the power supply.
3. Connect the positive and negative terminals of the power supply output to the VIN and GND pins, respectively.
4. Turn the power supply on. The board will automatically start up. Fixed output versions are shown in Table 2.

Table 2—Fixed output version information

Part Number	Fixed V _{OUT} (V)
MP1606GTF-08	0.8
MP1606GTF-09	0.9
MP1606GTF-10	1.0
MP1606GTF-12	1.2
MP1606GTF-135	1.35
MP1606GTF-20	2.0
MP1606GTF-285	2.85
MP1606GTF-32	3.2

NOTICE: The information in this document is subject to change without notice. Please contact MPS for current specifications. Users should warrant and guarantee that third party Intellectual Property rights are not infringed upon when integrating MPS products into any application. MPS will not assume any legal responsibility for any said applications.