

DESCRIPTION

The EV157-S-00A Evaluation Board is designed to demonstrate the capabilities of MP157GS. MP157 is a primary side regulator providing accurate constant voltage (CV) regulation without the Opto-coupler. It supports Buck, Buck-Boost, Boost and Flyback topologies.

The EV157-S-00A Evaluation Board is designed as Buck application. The EV157-S-00A typically drives a 4.2W with a 12V_{TYP}, 350mA load from 85VAC to 265VAC, at 50Hz.

The EV157-S-00A has excellent efficiency and meets EN55022 conducted EMI requirements. It has multiple protections, including open-circuit protection, short-circuit protection, over load protection and over-temperature protection, etc.

MP157GS is available in the SOIC8 packages.

ELECTRICAL SPECIFICATION

Parameter	Symbol	Value	Units
Input Voltage	V _{IN}	85 to 265	VAC
Output Voltage	V _{OUT}	12	V
Output Current	I _{out}	350	mA
Output Power	P _{out}	4.2W	W
Average Efficiency	η	>75.00	%

FEATURES

- Primary side constant voltage (CV) control
- Integrated 500V/10Ω MOSFET
- < 100mW No-load power consumption
- Up to 6W output power
- Maximum discontinuous conduction mode (DCM) output current less than 225mA, maximum continuous conduction mode (CCM) output current less than 360mA
- Low V_{cc} Operating Current
- Frequency Foldback
- Limited maximum frequency
- Peak Current Compression
- Internal High Voltage Current Source
- Internal 400ns Leading Edge Blanking
- Thermal Shutdown (auto restart)
- V_{CC} Under Voltage Lockout with Hysteresis (UVLO)
- Timer based Over Load Protection
- Short Circuit Protection
- Open Loop Protection

APPLICATIONS

- Home Appliances, White Goods and Consumer Electronics
- Industrial Controls
- Standby Power

All MPS parts are lead-free and adhere to the RoHS directive. For MPS green status, please visit MPS website under Products, Quality Assurance page. "MPS" and "The Future of Analog IC Technology" are registered trademarks of Monolithic Power Systems, Inc.

EV157-S-00A EVALUATION BOARD



(L x W x H) 4.5cm x 2.5cm x 1.7cm

Board Number	MPS IC Number
EV157-S-00A	MP157GS

EVALUATION BOARD SCHEMATIC

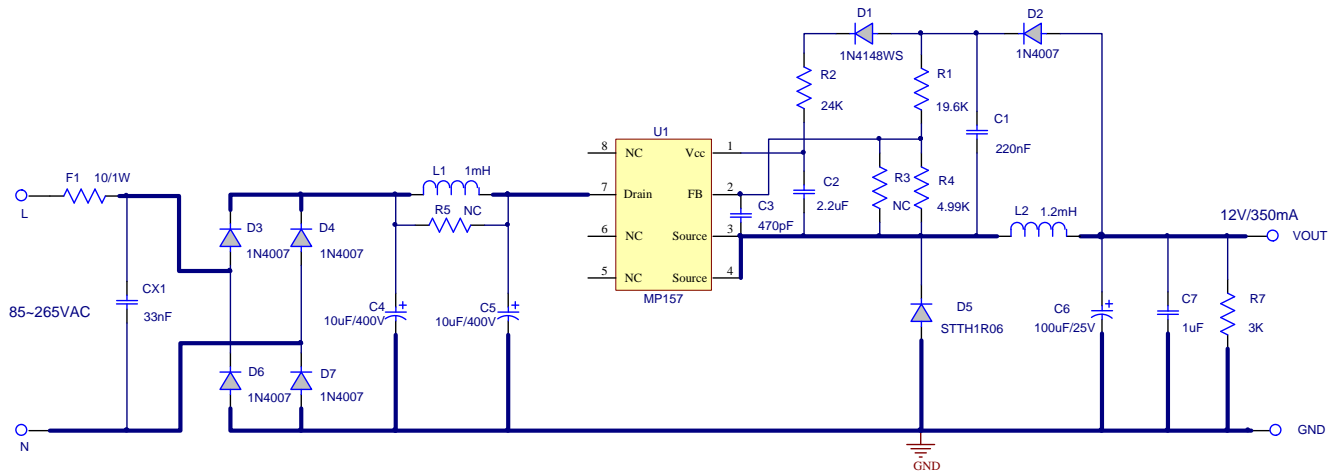

EV157-S-00A BILL OF MATERIALS

Qty	Ref	Value	Description	Package	Manufacture	Manufacture_PN
1	C1	220nF	Ceramic Capacitor;16V;X7R;0603;	0603	muRata	GRM188R71C224KA01D
1	C2	2.2μF	Ceramic Capacitor;10V;X7R;0603;	0603	muRata	GRM188R71A225KE15D
1	C3	470pF	Ceramic Capacitor;50V;X7R;0603;	0603	muRata	GRM188R71H471KA01D
2	C4, C5	10μF/400V	Electrolytic Capacitor;400V;20%	DIP	Any	Any
1	C6	100μF/35V	Electrolytic Capacitor;35V;Electrolytic	DIP	Jianghai	CD287-35V100
1	C7	1μF	Ceramic Capacitor;16V;X7R;0603;	0603	muRata	GRM188R71C105KA12D
1	CX1	33nF	Capacitor;275V;10%	DIP	Carli	PX333K3IB29L270D9R
1	D1	1N4148WS	Diode;75V;0.15A;	SOD-323	Diodes	1N4148WS-7-F
5	D2, D3, D4, D6, D7	1N4007	Diode;1000V;1A	DO-41	Diodes	1N4007
1	D5	STTH1R06	Diode;600V;1A	DO-41	ST	STTH1R06
1	F1	10/1W	Resistor;5%;1W	DIP	Yageo	FKN1WSJT-52-10R
1	L1	1mH	Inductor;1000uH;8 Ohm;0.1A	DIP	Any	Any
1	L2	1.2mH	Inductor;1.2mH;1.8Ω;400 mA	DIP	Yimei	DR9X12P2M1.2-00
1	R1	19.6k	Film Resistor;1%;	0603	Yageo	RC0603FR-0719K6L
1	R2	24k	Film Resistor;1%;	0603	Yageo	RC0603FR-0724KL
1	R4	4.99k	Film Resistor;1%;	0603	Yageo	RC0603FR-074K99L
1	R7	3k	Film Resistor;1%	1206	Yageo	RC1206FR-073KL
1	U1	MP157GS	Primary side regulator	SOIC8	MPS	MP157GS

EVB TEST RESULTS

Performance waveforms are tested on the evaluation board.

$V_{IN} = 85\text{--}265\text{VAC}$, $V_{OUT} = 12\text{V}$, $I_{OUT} = 350\text{mA}$, $T_A = 25^\circ\text{C}$, unless otherwise noted.

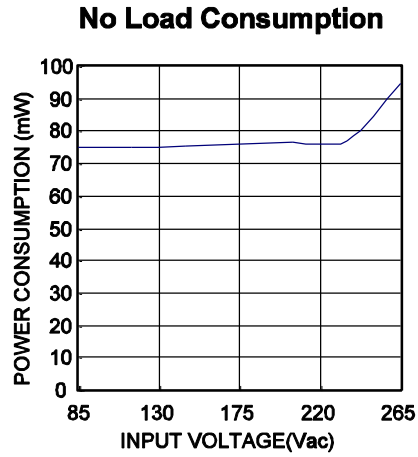
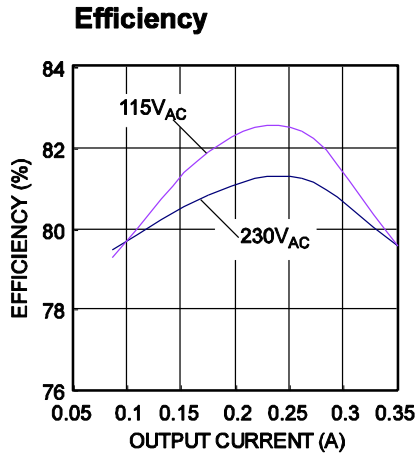

Normal Operation
 $V_{IN} = 115\text{VAC}$, Full Load

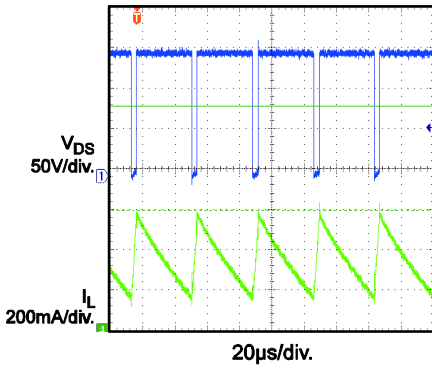

Normal Operation
 $V_{IN} = 230\text{VAC}$, Full Load

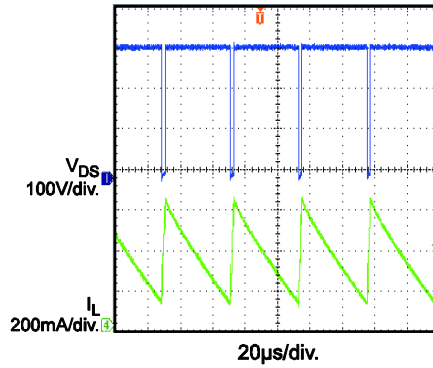

Output Ripple
 $V_{IN} = 115\text{VAC}$, No Load

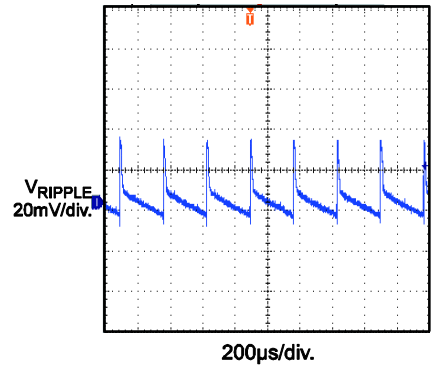

Output Ripple
 $V_{IN} = 115\text{VAC}$, Full Load

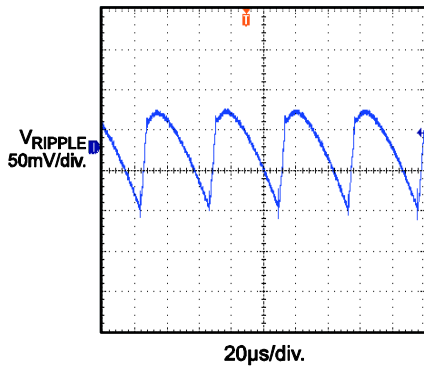

Output Ripple
 $V_{IN} = 230\text{VAC}$, No Load

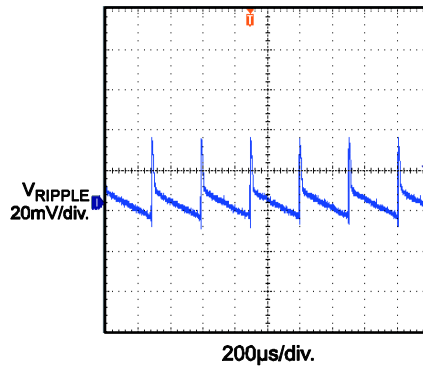

Output Ripple
 $V_{IN} = 230\text{VAC}$, Full Load

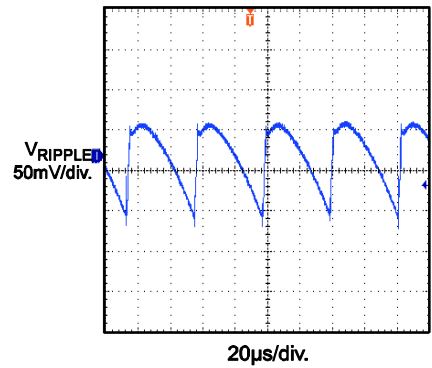

EVB TEST RESULTS *(continued)*

Performance waveforms are tested on the evaluation board.

 $V_{IN} = 85\text{--}265\text{VAC}$, $V_{OUT} = 12\text{V}$, $I_{OUT} = 350\text{mA}$, $T_A = 25^\circ\text{C}$, unless otherwise noted.

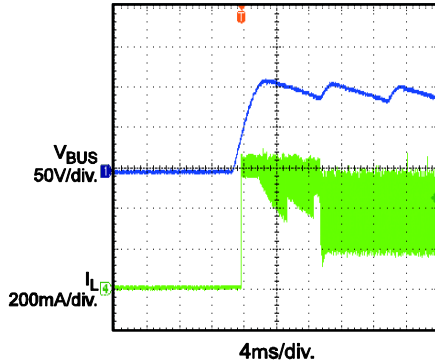
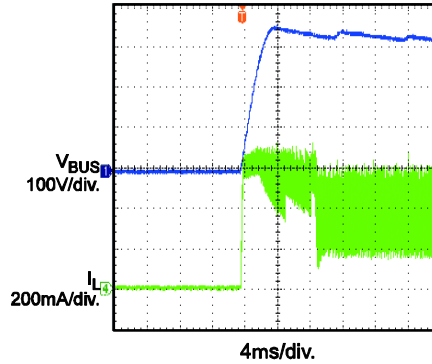
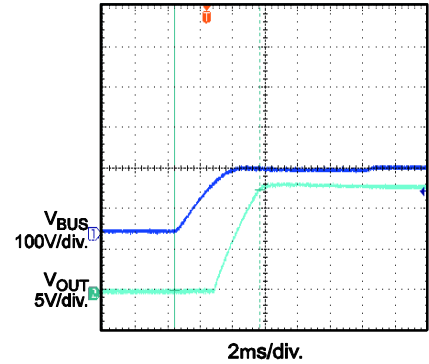
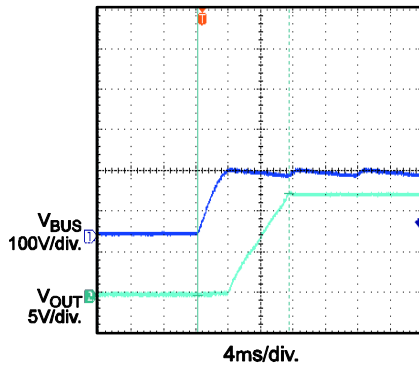
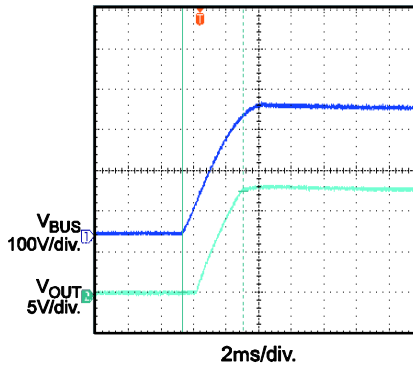
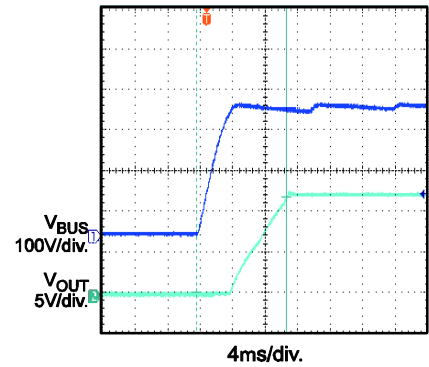
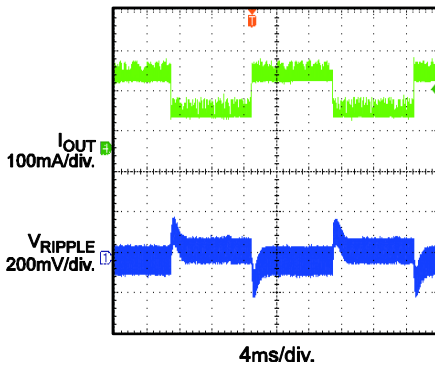
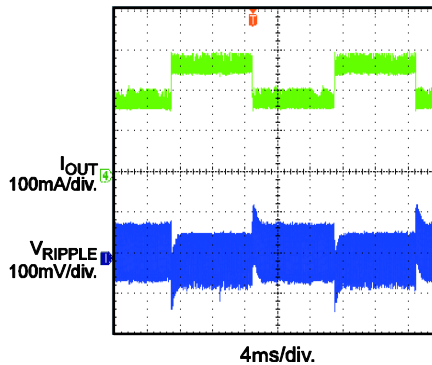
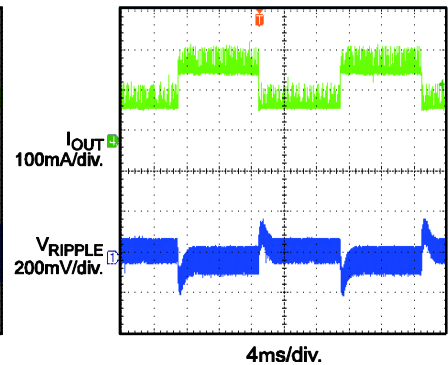
Soft Start
 $V_{IN} = 85\text{VAC}$

Soft Start
 $V_{IN} = 265\text{VAC}$

Turn-on Delay
 $V_{IN} = 115\text{VAC}$, No Load

Turn-on Delay
 $V_{IN} = 115\text{VAC}$, Full Load

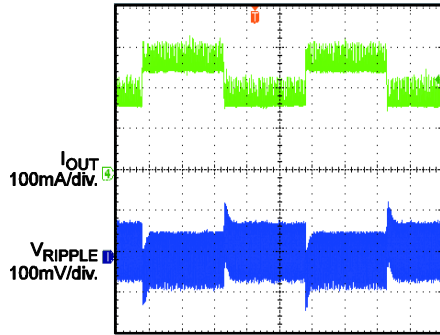
Turn-on Delay
 $V_{IN} = 230\text{VAC}$, No Load

Turn-on Delay
 $V_{IN} = 230\text{VAC}$, Full Load

Load Transient
 $V_{IN} = 115\text{VAC}$,
25% Load to 50% Load

Load Transient
 $V_{IN} = 230\text{VAC}$,
25% Load to 50% Load

Load Transient
 $V_{IN} = 115\text{VAC}$,
50% Load to 75% Load

EVB TEST RESULTS *(continued)*

Performance waveforms are tested on the evaluation board.

 $V_{IN} = 85\sim 265VAC$, $V_{OUT} = 12V$, $I_{OUT} = 350mA$, $T_A = 25^\circ C$, unless otherwise noted.

Load Transient
 $V_{IN} = 230VAC$,
50% Load to 75% Load

4ms/div.

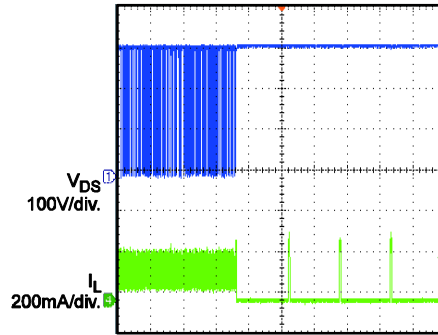
OLP Protection
 $V_{IN} = 230VAC$

100ms/div.

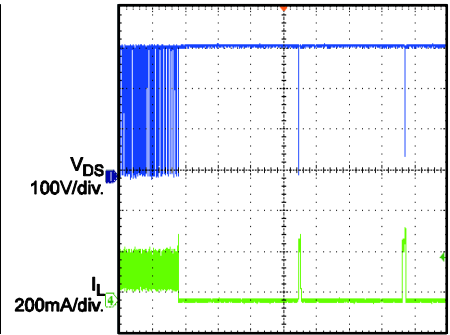
SCP Protection
 $V_{IN} = 230VAC$

100ms/div.

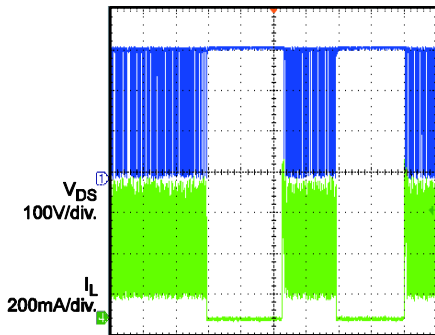
Thermal Down

100ms/div.

Open Loop

Full Load

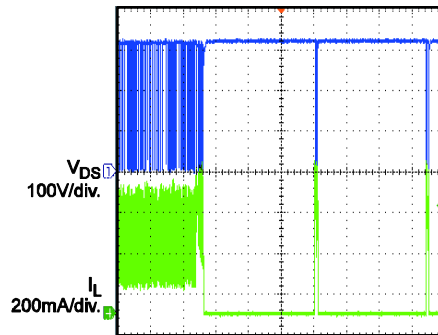

100ms/div.

Open Loop

No Load

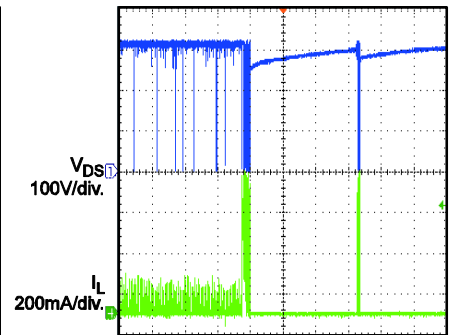

100ms/div.

Conducted EMI

 Two-Wire Input, $V_{IN} = 230VAC$

L Line

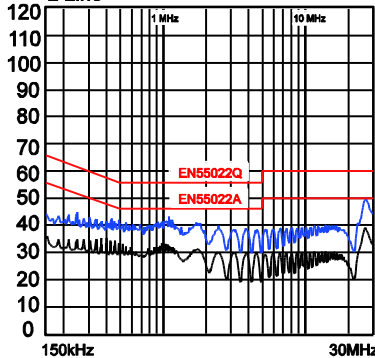
Conducted EMI

 Two-Wire Input, $V_{IN} = 230VAC$

N Line

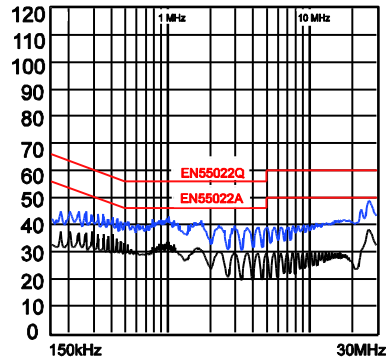

SURGE PERFORMANCE

The circuit pass the 1000V surge.

Surge Level (V)	Input Voltage (VAC)	Injection Location	Injection Phase(o)	Number of Surges	Test Result
1000	220	L-N	0	5	PASS
1000	220	L-N	90	5	PASS
1000	220	L-N	180	5	PASS
1000	220	L-N	270	5	PASS
-1000	220	L-N	0	5	PASS
-1000	220	L-N	90	5	PASS
-1000	220	L-N	180	5	PASS
-1000	220	L-N	270	5	PASS

With the input capacitors C4 (10 μ F) and C5 (10 μ F), the board can pass 1000V surge test. Table 1 shows the capacitance required under normal condition for different surge voltage.

Table 1 — Recommended Capacitor Values

Surge Voltage	500V	1000V	2000V
C1	3.3 μ F	10 μ F	Shown in Fig
C2	3.3 μ F	10 μ F	

The board can pass 2kV surge test by using the circuit below.

- 1) Change the fuse resistor F1 (10ohm/1W) to SS-5-2A
- 2) Add a MOV RV1 (TVR14431)
- 3) Add a resistor R8 (39 Ω)

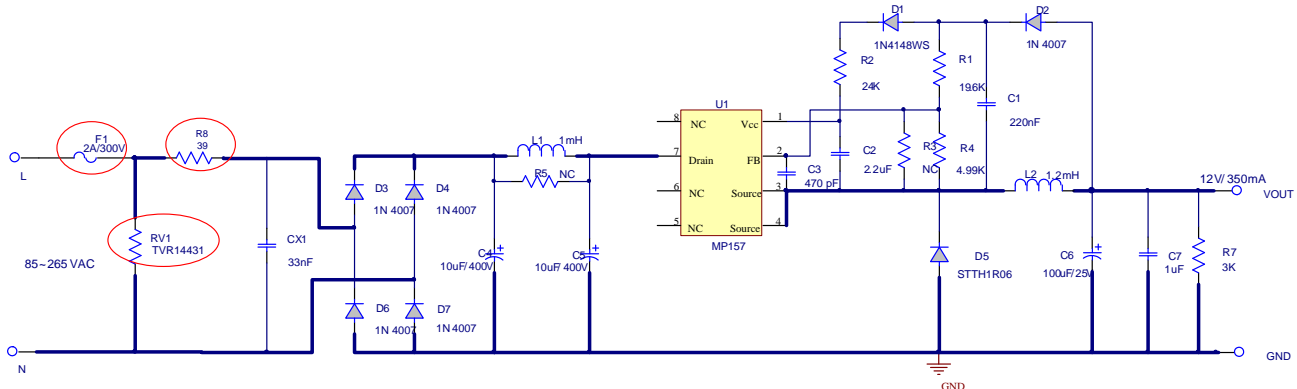

PRINTED CIRCUIT BOARD LAYOUT

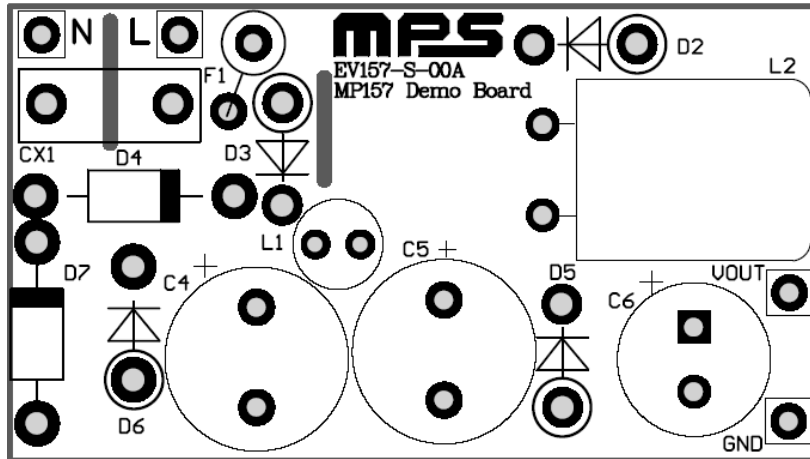

Figure 1 — Top Silk Layer

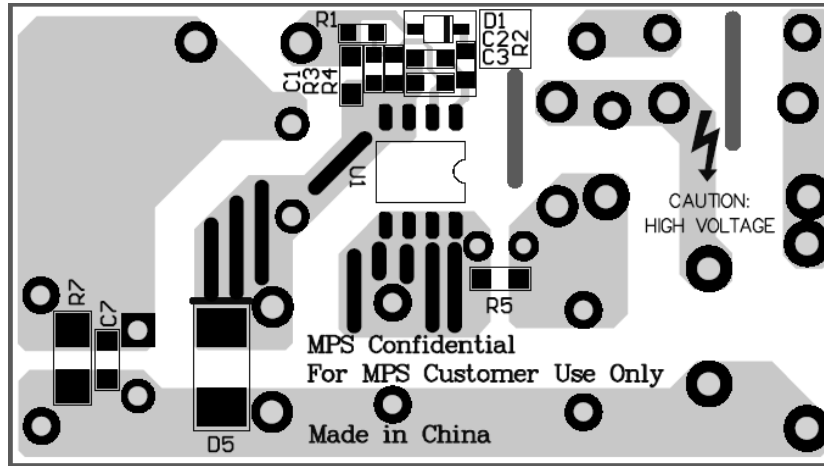

Figure 2 — Bottom Layer

QUICK START GUIDE

1. Preset Power Supply to $85\text{VAC} \leq V_{\text{IN}} \leq 265\text{VAC}$.
2. Turn Power Supply off.
3. Connect the Line and Neutral terminals of the power supply output to L and N port.
4. Connect the positive terminal of the load to “+” port, and connect the negative terminal of the load to “-” port.
5. Turn Power Supply on after making connections.

NOTICE: The information in this document is subject to change without notice. Please contact MPS for current specifications. Users should warrant and guarantee that third party Intellectual Property rights are not infringed upon when integrating MPS products into any application. MPS will not assume any legal responsibility for any said applications.