

GENERAL DESCRIPTION

The EV1517DR-00A is the evaluation board for the MP1517, a 3A, fixed frequency step-up converter ideal for medium-to-high current step-up applications. The high 1.1MHz switching frequency allows for smaller external components producing a compact solution for size constrained cameras, PDAs and cell phones. The low 0.7V feedback voltage offers higher efficiency in white LED driver applications including cell phone camera flash. The MP1517 regulates the output voltage up to 25V with efficiencies greater than 90%. Soft-start, cycle-by-cycle current limiting, and input under voltage lockout prevent overstressing or damage to sensitive external circuitry at startup and output short-circuit conditions. Current-mode regulation and external compensation components allow the MP1517 control loop to be optimized over a wide variety of input voltage, output voltage, and load current conditions. The MP1517 is available in the thermally enhanced QFN16 (4mm x 4mm) package.

ELECTRICAL SPECIFICATIONS

Parameter	Symbol	Value	Units
Input Voltage	V_{IN}	5	V
Output Voltage	V_{OUT}	12	V
Output Current	I_{OUT}	1	A

FEATURES

- 4A Peak Current Limit
- Low 700mV Feedback Threshold
- Internal 150mΩ Power Switch
- Input Range of 2.6V to 25V
- Over 90% Efficiency
- Zero Current Shutdown Mode
- Under Voltage Lockout Protection
- Open Load Protection
- Soft-Start Operation
- Thermal Shutdown
- Tiny 4mm x 4mm 16-Pin QFN Package

APPLICATIONS

- Boost and SEPIC Regulators
- Handheld Computers
- Cell Phone Camera Flash, PDAs
- Digital Still and Video Cameras

"MPS" and "The Future of Analog IC Technology", are Trademarks of Monolithic Power Systems, Inc.

EV1517DR-00A EVALUATION BOARD



Dimensions (2.0"X x 2.0"Y x 0.4"Z)

Board Number	MPS IC Number
EV1517DR-00A	MP1517DR

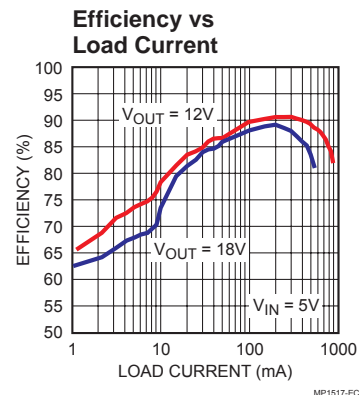

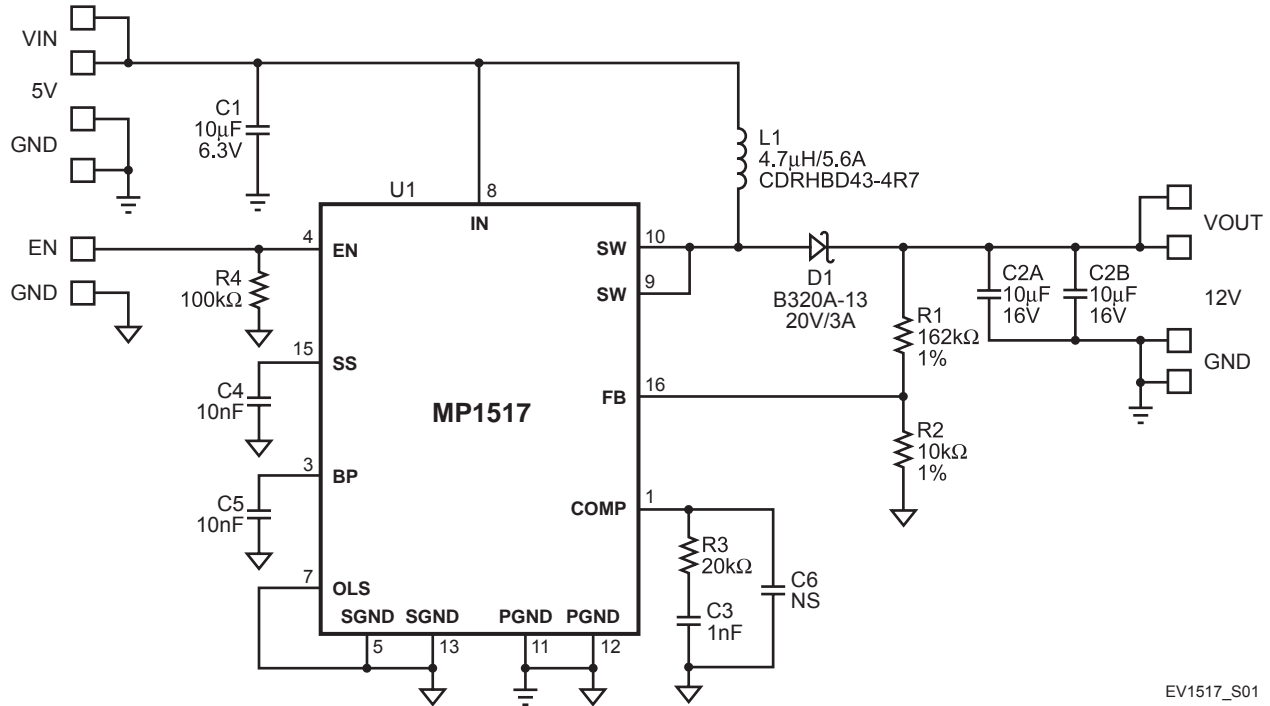
EVALUATION BOARD SCHEMATIC

EV1517_S01

EV1517DR-00A BILL OF MATERIALS

Qty	Ref	Value	Description	Package	Manufacturer	Manufacturer P/N
1	C1	10µF	Ceramic Cap, 6.3V, X5R	1210	TDK	C3225X5R1A106K
2	C2A, C2B	10µF	Ceramic Cap, 16V, X7R	1210	TDK	C3225X7R1C106M
1	C3	1nF	Ceramic Cap, 50V, X7R	0805	TDK	C2012X7R1H102K
2	C4, C5	10nF	Ceramic Cap, 50V, X7R	0805	TDK	C2012X7R1H103K
1	C6		Do Not Stuff			
1	D1		Schottky Diode, 20V, 3A, SMA		Diodes Inc	B320A-13
1	L1	4.7µH 5.6A			Sumida	CDRH8D43-4R7NC
1	R1	162kΩ	Metal Film Res, 1%	0805	Panasonic	ERJ-6ENF1623V
1	R2	10kΩ	Metal Film Res, 1%	0805	Panasonic	ERJ-6ENF1002V
1	R3	20kΩ	Metal Film Res, 5%	0805	Panasonic	ERJ-6GEYJ203V
1	R4	100kΩ	Metal Film Res, 5%	0805	Panasonic	ERJ-6GEYJ104V
1	U1		DC-DC Converter		MPS	MP1517DR

PRINTED CIRCUIT BOARD LAYOUT

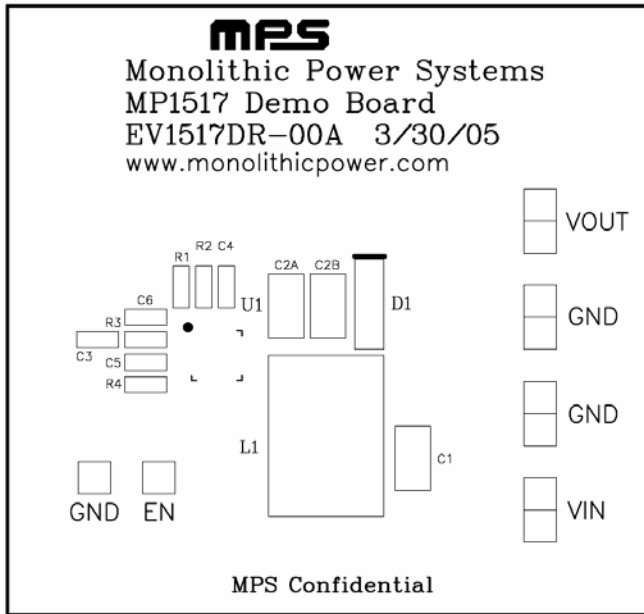

Figure 1—Top Silk Layer

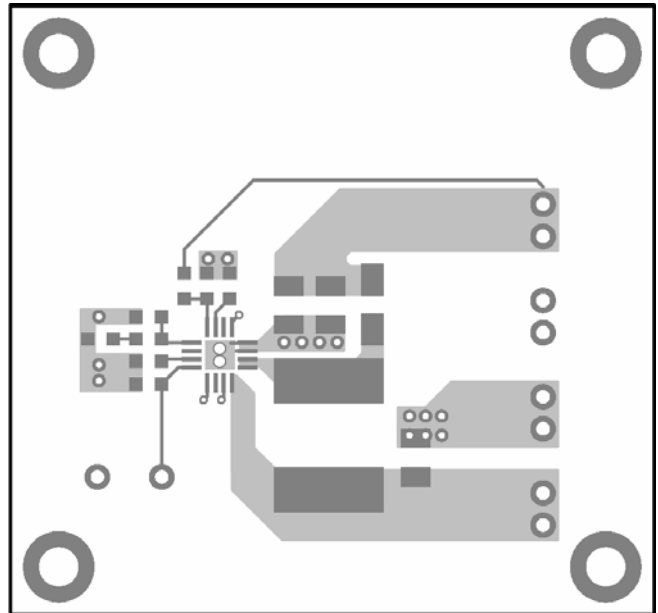

Figure 2—Top Layer

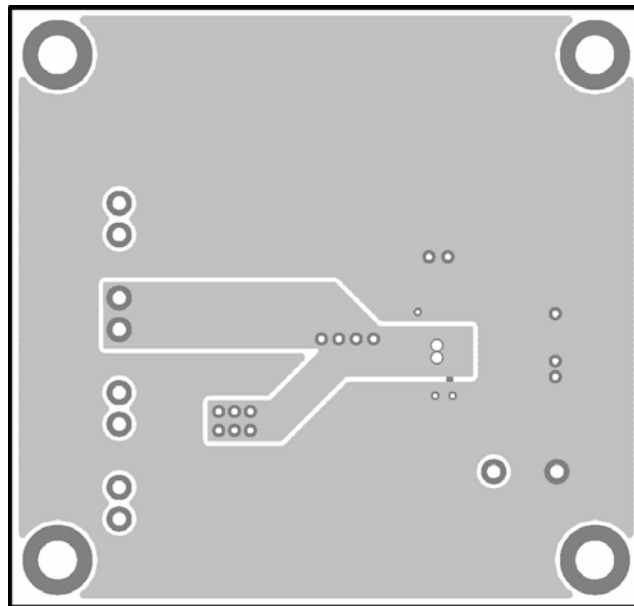
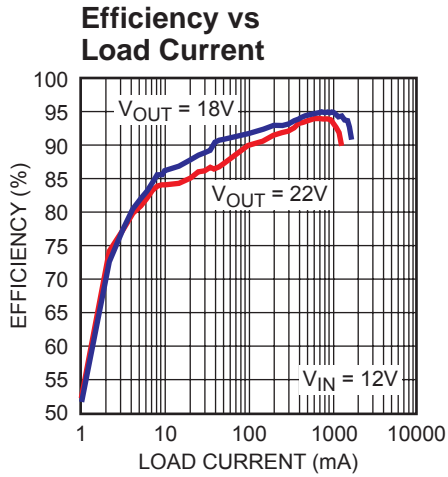
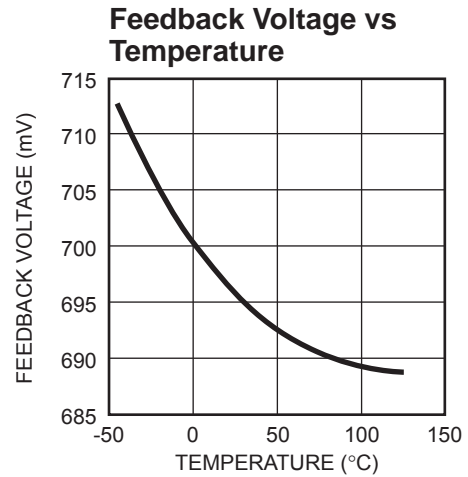

Figure 3—Bottom Layer

TYPICAL PERFORMANCE CHARACTERISTICS



MP1517-EC01



MP1517-TPC01

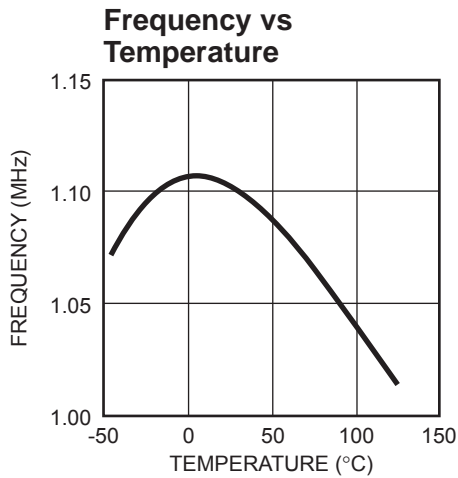

MP1517-TPC02

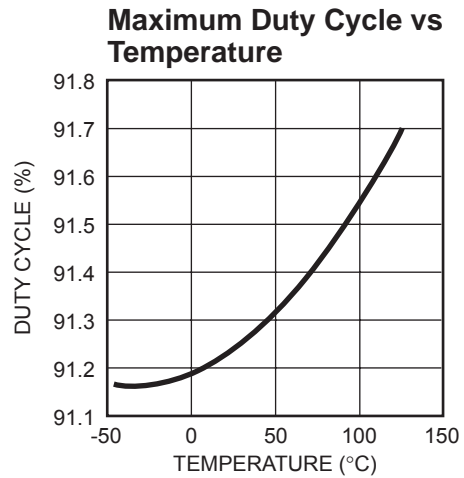

MP1517-TPC03

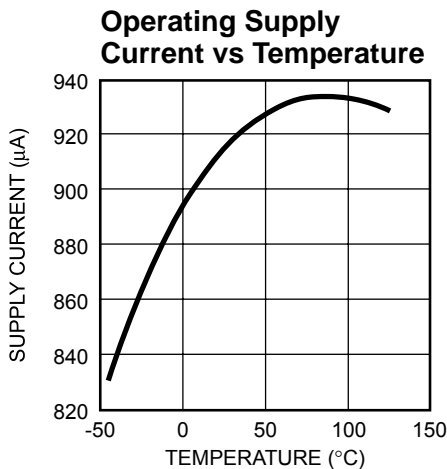

MP1517-TPC04

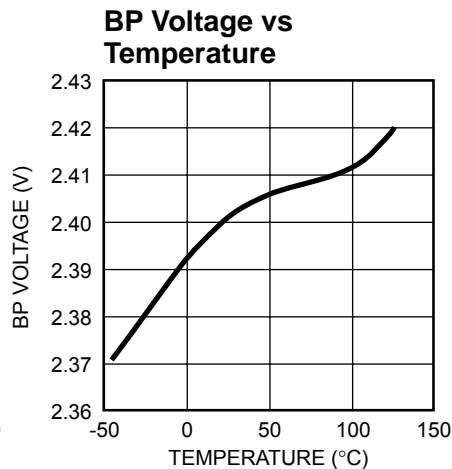

MP1517-TPC05

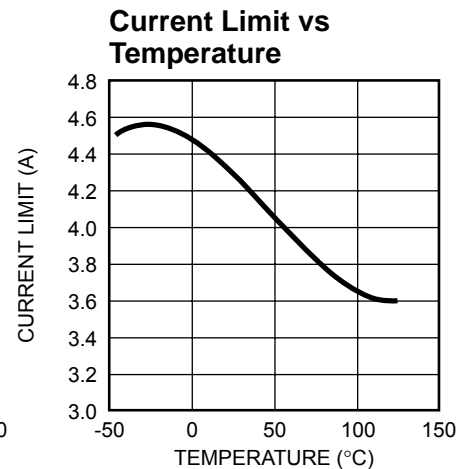

MP1517-TPC06

QUICK START GUIDE

The output voltage of this board is set to 12V. The board layout accommodates most commonly used inductors and output capacitors.

1. Preset Power Supply to $2.6V \leq V_{IN} \leq 6V$.
2. Turn Power Supply off.
3. Connect Power Supply terminals to:
 - Positive (+): VIN, EN
 - Negative (-): GND
4. Connect Load to:
 - Positive (+): VOUT
 - Negative (-): GND
5. Turn Power Supply on after making connections.
6. The MP1517 is enabled on the evaluation board once V_{IN} is applied. To disable the MP1517, disconnect EN from VIN.
7. The output voltage V_{OUT} can be changed by varying R1. Calculate the new value using the formula:

$$R1 = \left(\frac{V_{OUT}}{V_{FB}} - 1 \right) R2$$

Where $V_{FB} = 0.7V$ and $R2 = 10k\Omega$

For example, for $V_{OUT} = 15V$

$$R1 = \left(\frac{15V}{0.7V} - 1 \right) \times 10k\Omega = 204.3k\Omega$$

Therefore use a 205k Ω standard 1% value resistor.

NOTICE: The information in this document is subject to change without notice. Please contact MPS for current specifications. Users should warrant and guarantee that third party Intellectual Property rights are not infringed upon when integrating MPS products into any application. MPS will not assume any legal responsibility for any said applications.