

## DESCRIPTION

The EV1477-TF-00B Evaluation Board is designed to demonstrate the capabilities of MPS' MP1477, a fully-integrated high-frequency, synchronous rectified, step-down, switch-mode converter with internal power MOSFETs. It offers a very compact solution to achieve a 3A continuous output current over a wide input range, with excellent load and line regulation. The MP1477 has synchronous-mode operation for higher efficiency over the output current-load range.

Constant On-Time control operation provides very fast transient response and easy loop design as well as very tight output regulation.

Full protection features include SCP, OCP, UVP, and thermal shutdown.

The MP1477 requires a minimal number of readily-available, standard, external components and is available in a space-saving SOT563 (1.6mmx1.6mm) package.

## ELECTRICAL SPECIFICATION (1)

Parameter	Symbol	Value	Units
Input Voltage	$V_{IN}$	12	V
Output Voltage	$V_{OUT}$	3.3	V
Output Current	$I_{OUT}$	3	A

### Notes:

1) For different Input/output voltage specs and different output capacitor/inductor may need change the application circuit parameters.

## FEATURES

- Wide 4.2V-to-17V Operating Input Range
- 58mΩ/25mΩ Low- $R_{DS(ON)}$  Internal Power MOSFETs
- 180μA Low IQ Current
- High-Efficiency Synchronous-Mode Operation
- Power Save Mode at Light Load
- Fast Load Transient Response
- 800kHz Switching Frequency
- Internal Soft-Start
- Over-Current Protection and Hiccup
- Thermal Shutdown
- Output Adjustable from 0.8V
- Available in a SOT563(1.6mmx1.6mm) package

## APPLICATIONS

- Security Camera
- Digital Set-Top Boxes
- Flat-Panel Television and Monitors
- General Purposes

All MPS parts are lead-free, halogen free, and adhere to the RoHS directive. For MPS green status, please visit MPS website under Quality Assurance.

"MPS" and "The Future of Analog IC Technology" are Registered Trademarks of Monolithic Power Systems, Inc.

## EV1477-TF-00B EVALUATION BOARD



(L x W x H) 63.7mm x 48.4mm x 6.4mm

Board Number	MPS IC Number
EV1477-TF-00B	MP1477GTF

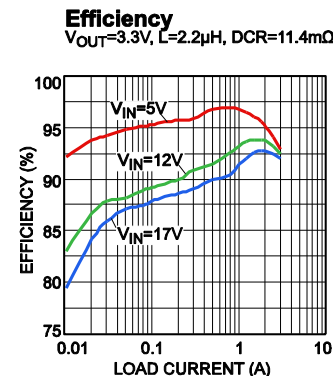

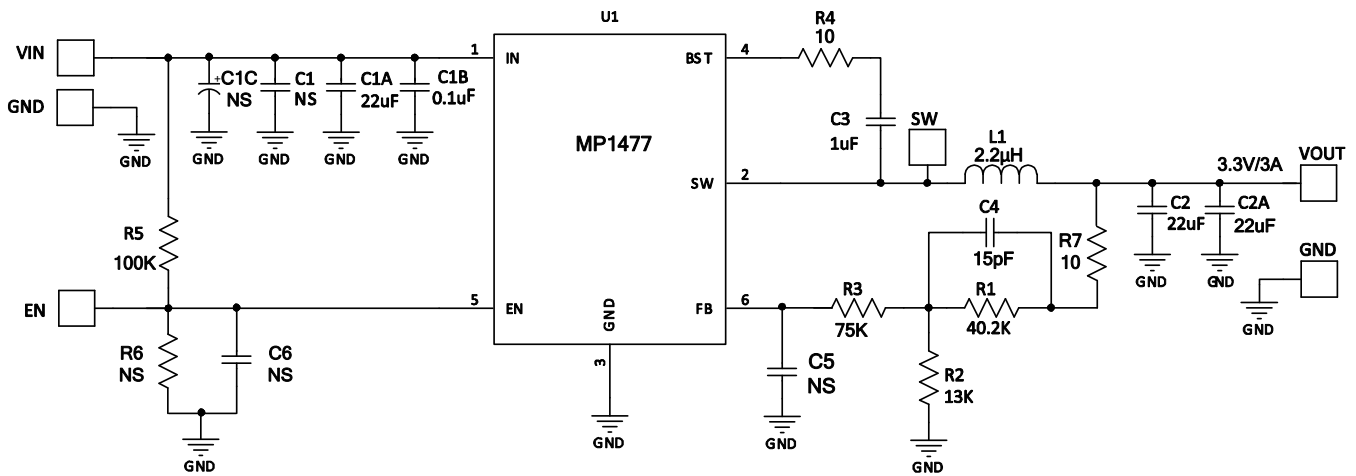
**EVALUATION BOARD SCHEMATIC**

**EV1477-TF-00B BILL OF MATERIALS**

Qty	Ref	Value	Description	Package	Manufacturer	Part Number
1	C1A	22 $\mu$ F	Ceramic Cap., 25V, X5R	0805	muRata	GRM21BR61E226ME44L
1	C1B	0.1 $\mu$ F	Ceramic Cap., 25V, X7R	0603	muRata	GRM188R71E104KA01D
2	C2,C2A	22 $\mu$ F	Ceramic Cap., 16V, X5R	0805	muRata	GRM21BR61C226ME44L
1	C3	1 $\mu$ F	Ceramic Cap., 16V, X7R	0603	muRata	GRM188R71C105KA12D
0	C1,C1C, C5,C6	NS				
1	C4	15pF	Ceramic Cap., 50V, C0G	0603	muRata	GRM1885C1H150JA01D
1	R1	40.2k	Thick Film Res., 1%	0603	Yageo	RC0603FR-0740K2L
1	R2	13k	Thick Film Res., 1%	0603	Yageo	RC0603FR-0713KL
1	R3	75k	Thick Film Res., 1%	0603	Yageo	RC0603FR-0775KL
1	R5	100k	Thick Film Res., 1%	0603	Yageo	RC0603FR-07100KL
2	R4,R7	10 $\Omega$	Thick Film Res., 1%	0603	Yageo	RC0603JR-0710RL
0	R6	NS				
1	L1	2.2 $\mu$ H	Inductor, DCR=12m $\Omega$ , Is=14A	SMD	Würth	74437349022
1	U1	MP1477GTF	Synchronous Step-Down Convert	SOT563	MPS	MP1477GTF

## EVB TEST RESULTS

$V_{IN} = 12V$ ,  $V_{OUT} = 3.3V$ ,  $L = 2.2\mu H$ ,  $T_A = +25^\circ C$ , unless otherwise noted.

### Efficiency

$V_{OUT} = 3.3V$ ,  $L = 2.2\mu H$ ,  $DCR = 11.4m\Omega$

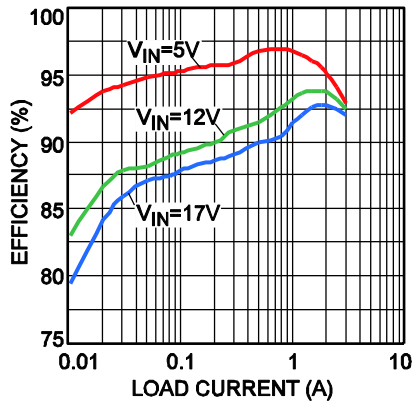

### Load Regulation

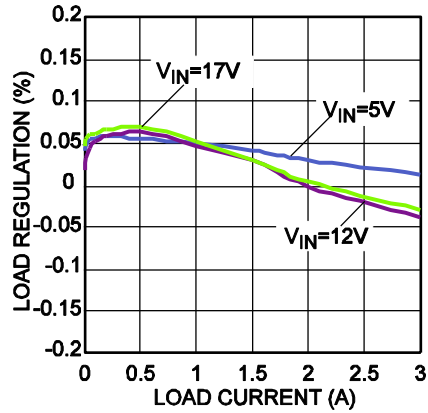

### Line Regulation

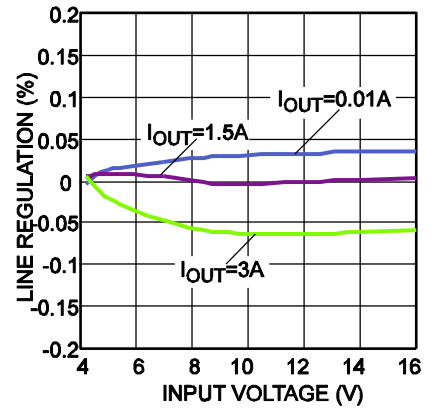

### Case Temperature Rise vs. Load Current

$T_A = 25^\circ C$ , Board Size: 6.3cm x 4.7cm

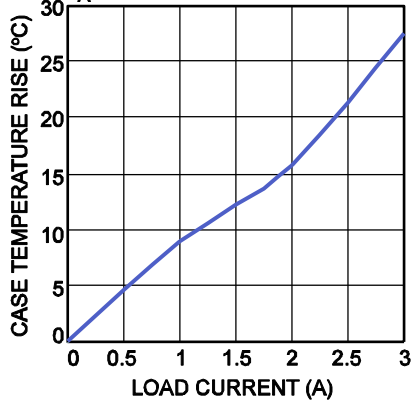

### Enabled Supply Current vs. Input Voltage

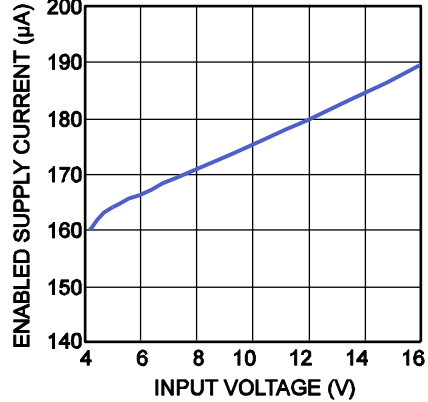

**EVB TEST RESULTS** *(continued)*
 $V_{IN} = 12V$ ,  $V_{OUT} = 3.3V$ ,  $L = 2.2\mu H$ ,  $T_A = +25^\circ C$ , unless otherwise noted.

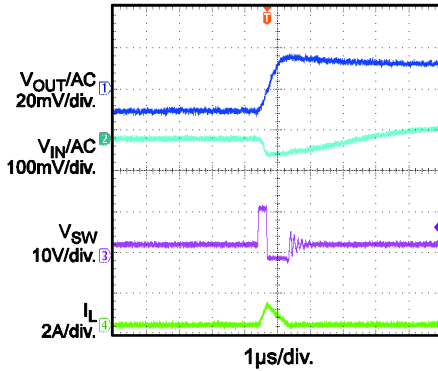
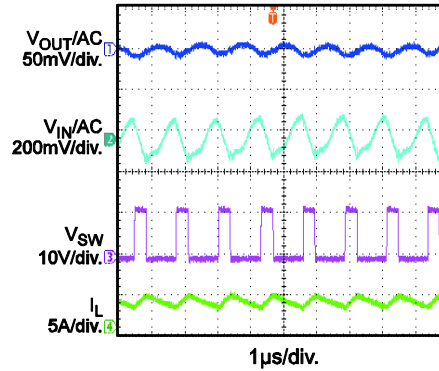
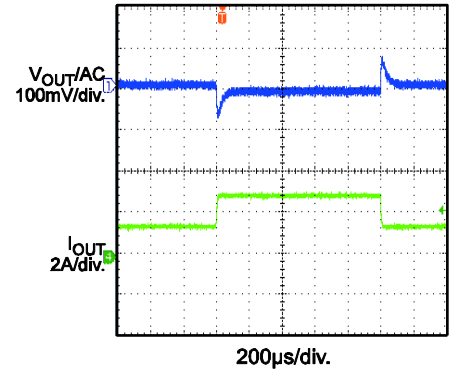
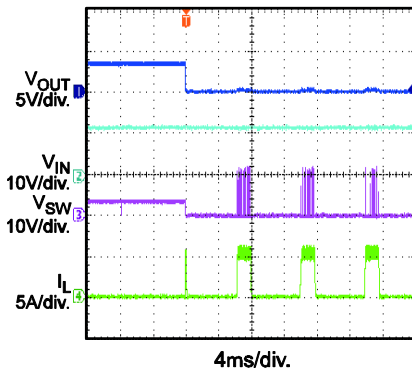
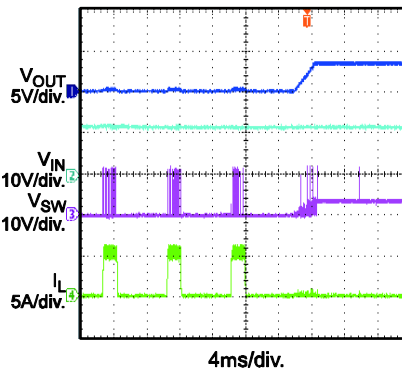
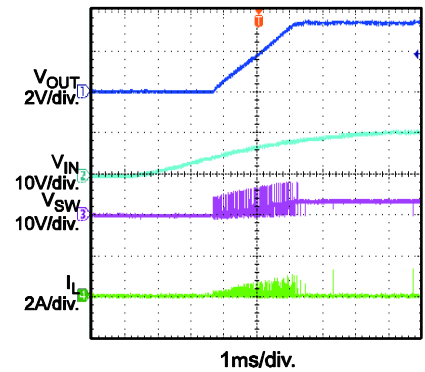
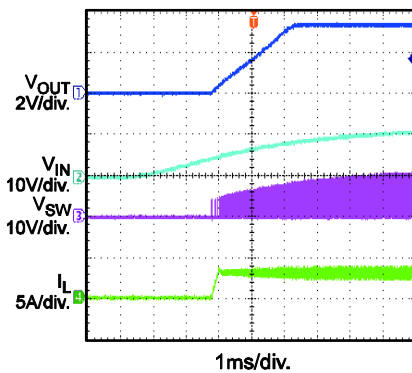
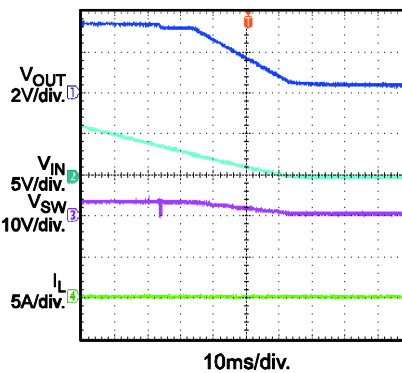
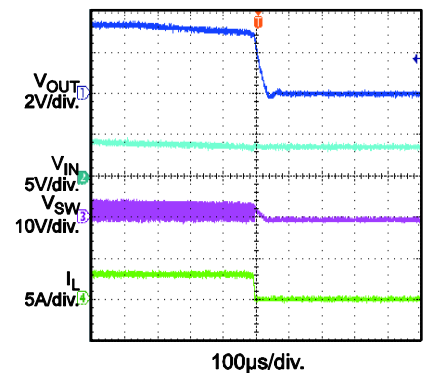
**Input/Output Ripple**
 $I_{OUT} = 0A$ 

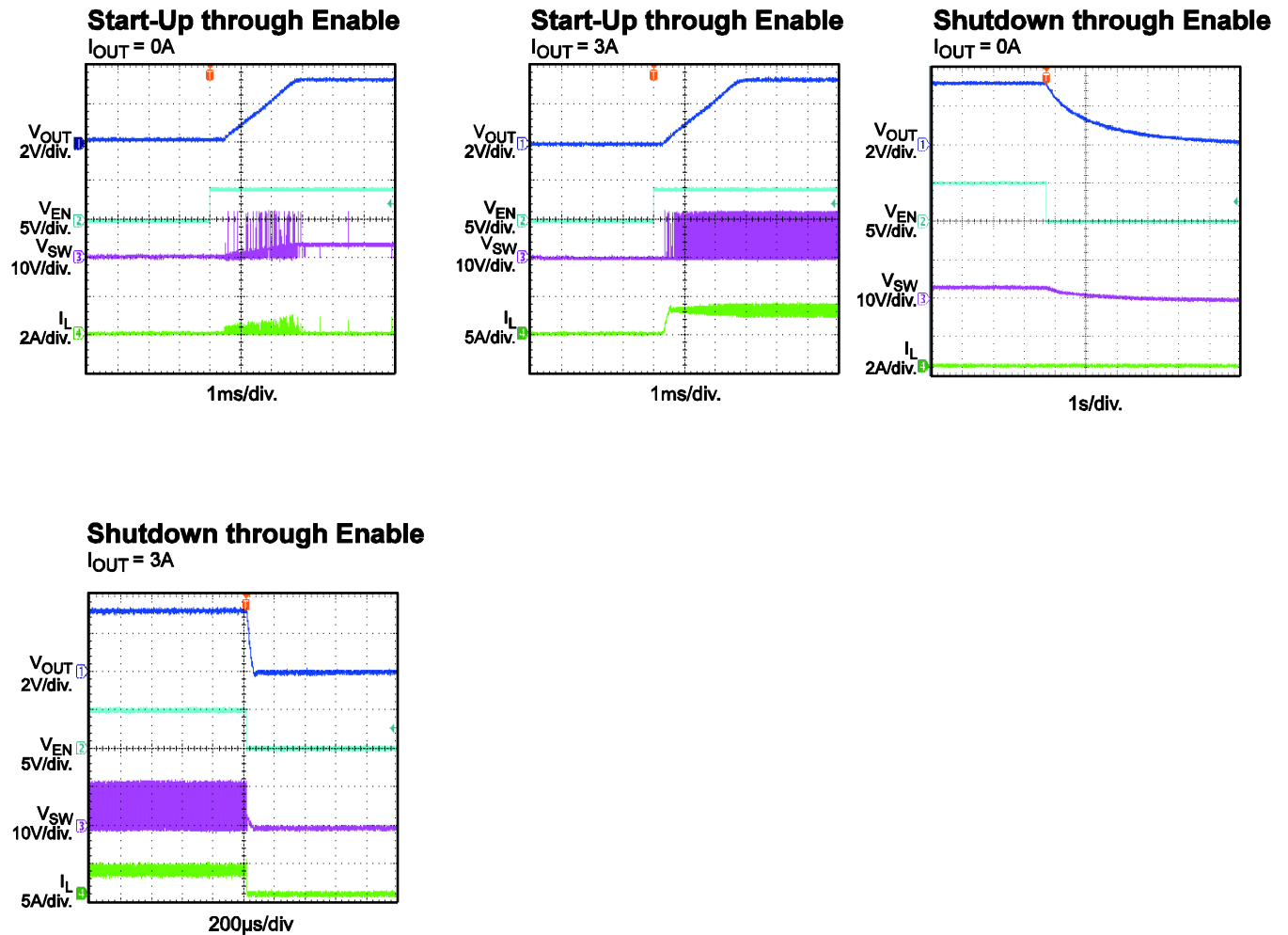
**Input/Output Ripple**
 $I_{OUT} = 3A$ 

**Transient Response**
 $I_{OUT} = 1.5A$  to  $3A$ ,  $2.5A/\mu s$ 

**Short Circuit Entry**
 $I_{OUT} = 0A$ 

**Short Circuit Recovery**
 $I_{OUT} = 0A$ 

**Start-Up through Input Voltage**
 $I_{OUT} = 0A$ 

**Start-Up through Input Voltage**
 $I_{OUT} = 3A$ 

**Shutdown through Input Voltage**
 $I_{OUT} = 0A$ 

**Shutdown through Input Voltage**
 $I_{OUT} = 3A$ 

**EVB TEST RESULTS** *(continued)*
 $V_{IN} = 12V$ ,  $V_{OUT} = 3.3V$ ,  $L = 2.2\mu H$ ,  $T_A = +25^\circ C$ , unless otherwise noted.

# PRINTED CIRCUIT BOARD LAYOUT

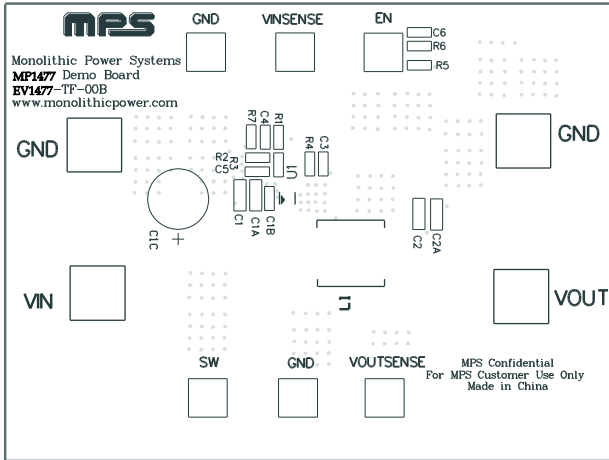

Figure1: Top Silk Layer

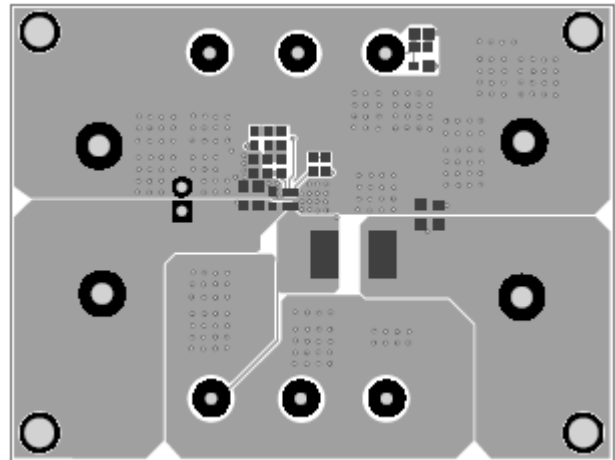

Figure2: Top Layer

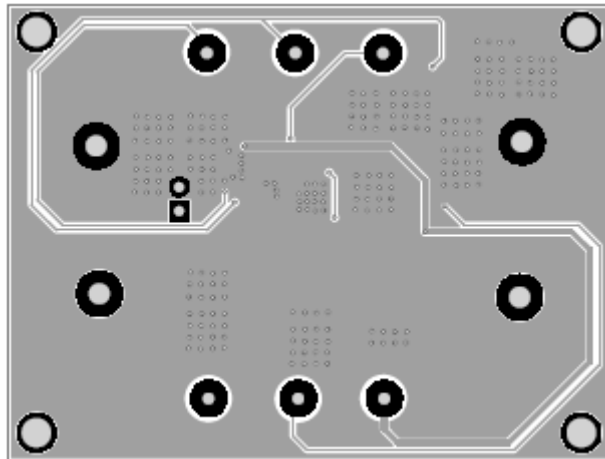

Figure3: Bottom Layer

## QUICK START GUIDE

1. Preset Power Supply to 12V.
2. Turn Power Supply off.
3. Connect Power Supply terminals to:
  - a. Positive (+): VIN
  - b. Negative (-): GND
4. Connect Load to:
  - a. Positive (+): VOUT
  - b. Negative (-): GND
5. Turn Power Supply on after making connections. The board will automatically start up.
6. To use the Enable function, apply a digital input to the EN pin. Drive EN higher than 1.3V to turn on the regulator, or less than 1V to turn it off.

**NOTICE:** The information in this document is subject to change without notice. Please contact MPS for current specifications. Users should warrant and guarantee that third party Intellectual Property rights are not infringed upon when integrating MPS products into any application. MPS will not assume any legal responsibility for any said applications.