



The Future of Analog IC Technology®

EV103-N-00A Offline Inductor-Less Controller EV Board

DESCRIPTION

The MP103 is a good efficiency off-line linear regulator that directly steps down the AC line voltage to a regulated DC voltage. It provides a simple solution to provide a bias voltage to any ICs in the off-line application. Off-line linear regulator is designed to replace the conventional switching converter; it features no inductor required, low EMI noise and low BOM cost.

MP103 features as a controller that supports to drive low cost bipolar junction transistor. MP103 integrates an adaptive active VB-VOUT charging window method. The MP103 only works when it is necessary and only when the loss generated on the device is minimal. Such operation can achieve good efficiency and can help the system meet the new standby power specification.

MP103 offers rich protections, such as Thermal Shutdown (TSD), Over Temperature Protection (OTP), VB Over Voltage Protection (OVP), VB Short to GND Protection, Over Load Protection (OLP), Short Circuit Protection (SCP), MP103 is available in the SOIC8E package.

ELECTRICAL SPECIFICATION

Parameter	Symbol	Value	Units
Supply Voltage	V_{IN}	85~265	VAC
Output Voltage	V_{OUT}	5	V
Output Current	I_{OUT}	60	mA

FEATURES

- Universal AC Input (85Vac-305Vac)
- Inductor-Less
- Less than 100mW Standby Power
- Excellent EMI
- Low BOM Cost
- Smart Control to Maximum Efficiency
- Adjustable Output Voltage from 1.5V to 15V
- Good Line and Load Regulation
- Support to Drive BJT
- Short Circuit Protection
- External Programmable Over Temperature Protection (OTP)

APPLICATIONS

- Wall Switches and Dimmers
- Z-Wave Device and ZigBee Device for Home Automation
- Standby Power for General Off-line Applications

All MPS parts are lead-free and adhere to the RoHS directive. For MPS green status, please visit MPS website under Quality Assurance. "MPS" and "The Future of Analog IC Technology" are Registered Trademarks of Monolithic Power Systems, Inc.

EV103-N-00A EVALUATION BOARD

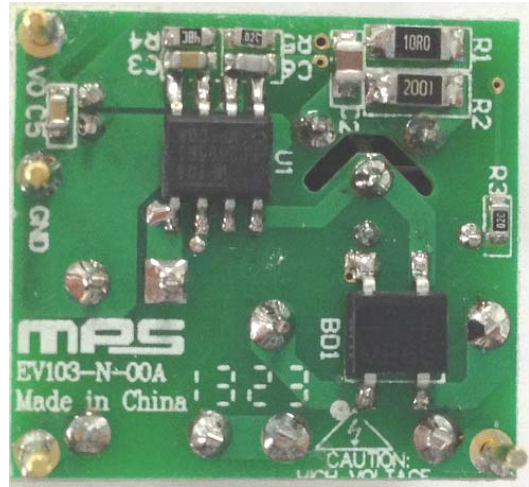

(L x W x H) 22mm x 24mm x 24mm

Board Number	MPS IC Number
EV103-N-00A	MP103GN

EVALUATION BOARD SCHEMATIC

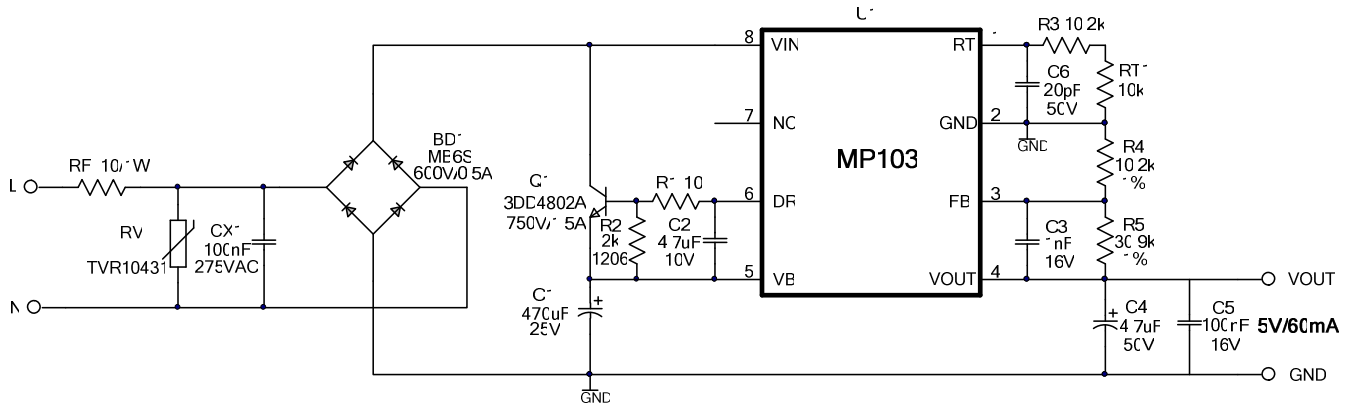

VOUT can be adjusted by choosing the value of R4 and R5, the relationship of them is:

$$V_{OUT} = 1.235V * (1 + R5/R4)$$

For example, to get 12V output voltage, we can choose, R4=10.2k, R5=90.9k.

The maximum output power (P_{OUT}) of MP103 Vs input voltage (V_{IN}) is depicted by following chart for 12V, 5V and 3.3V output applications respectively.

The test condition is: in open frame, ambient temperature is 25 °C, the temperature rise of MP103 is less than 60 °C on the test board.

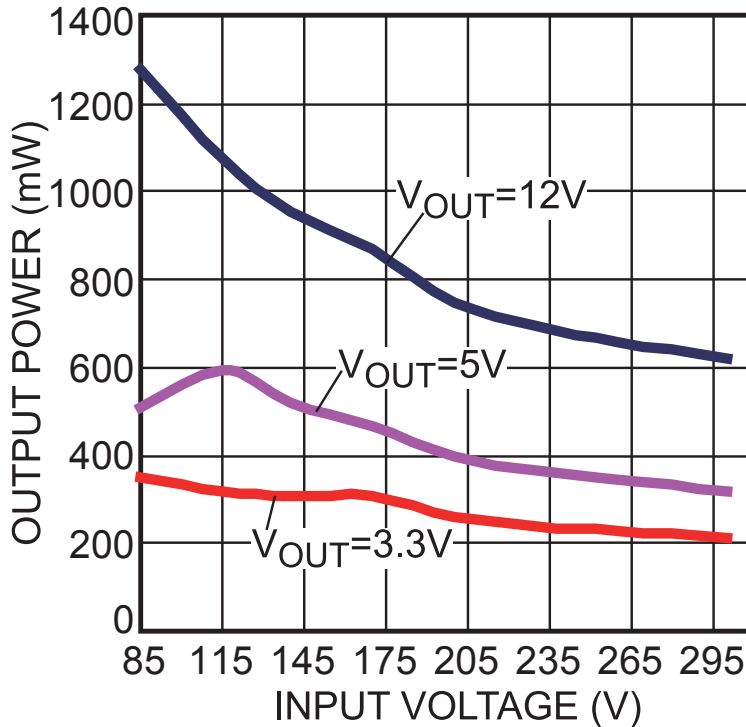

EV103-N-00A BILL OF MATERIAL

Qty	Ref	Value	Description	Package	Manufacture	Manufacturer_PN
1	BD1	MB6S	Diode;600V;0.5A;	SOIC-4	TaiWan Semiconductor	MB6S
1	C1	470 μ F	Electrolytic Capacitor; 25V;	DIP	Jianghai	CD287-25V470
1	C2	4.7 μ F	Ceramic Capacitor; 16V;	0805	Murata	GRM21BR61C475KA88L
1	C3	1nF	Ceramic Capacitor; 16V;X7R;	0603	Murata	GRM188R71C102KA01
1	C4	4.7 μ F	Electrolytic Capacitor; 50V;	DIP	Jianghai	CD287-50V4.7
1	C5	100nF	Ceramic Capacitor; 16V;X7R;	0603	LION	0603B104K160T
1	C6	20pF	Ceramic Capacitor; 50V;NPO;	0603	HHEC	C0603N200J050T
1	CX1	100nF	Film Capacitor; 275V;10%	DIP	Kaili	PX104K31C39L270D9R
1	Q1	3DD4802A	BJT,750V,1.5A;	TO-220F	Huawei	3DD4802A
1	R1	10 Ω	Film Resistor;5%;	1206	Yageo	RC1206JR-0710R
1	R2	2k Ω	Film Resistor;5%;	1206	Royalohm	1206F2001T5E
2	R3, R5	10.2k Ω	Film Resistor;1%;	0603	Yageo	RC0603FR-0710K2L
1	R4	30.9k Ω	Film Resistor;1%;	0603	Yageo	RC0603FR-0730K9L
1	RF	10 Ω	Resistor;5%;1W	DIP	Bangdayuan	10 Ohm/1W
1	RT1	10k Ω	NTC Resistor;5%;	DIP	Shiheng	MF52A103J3470F
1	RV	275Vac	TVR10431KSY, 430V(1mA);	DIP	TKS	TVR10431KSY
1	U1	MP103	Offline Regulator	SOIC8E	MPS	MP103GN

EVB TEST RESULTS

Performance waveforms are tested on the evaluation board.

$V_{OUT} = 5V$, $I_{OUT} = 60mA$, $T_A = 25^{\circ}C$, unless otherwise noted.

Efficiency vs. Load

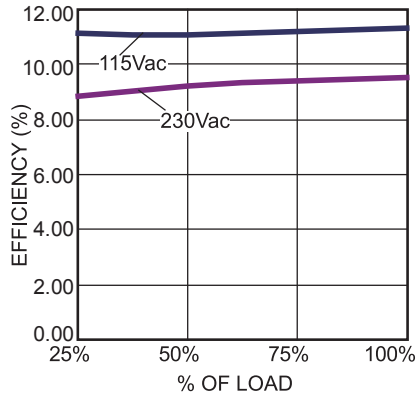

No Load Power vs. Input Voltage

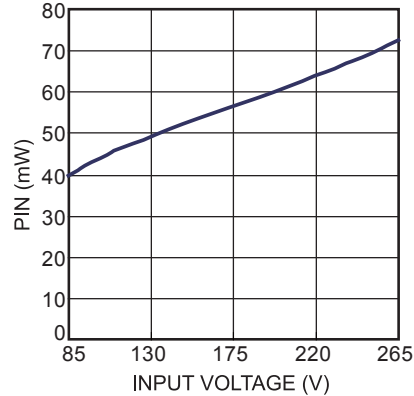

Input Power Startup
115Vac, 5V/60mA

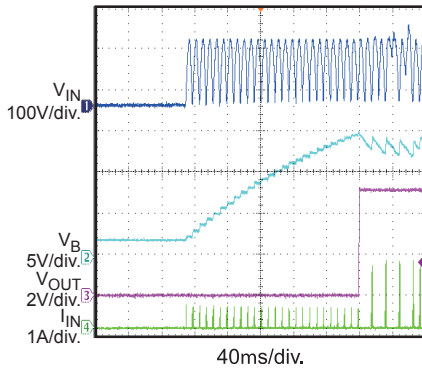

Input Power Startup
230Vac, 5V/60mA

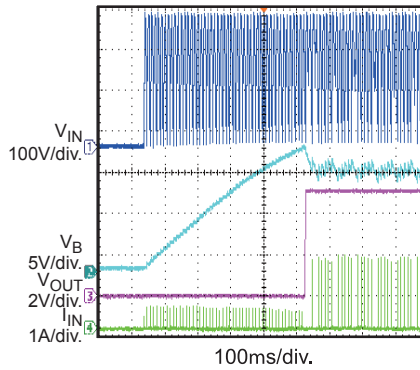

Steady State
115Vac, 5V/60mA

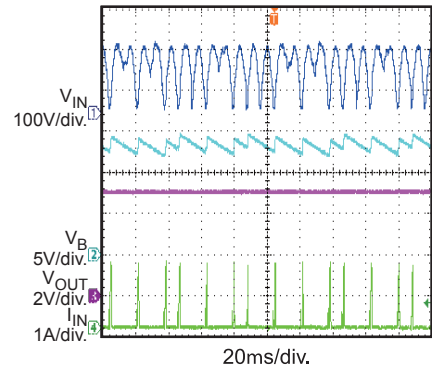

Steady State
230Vac, 5V/60mA

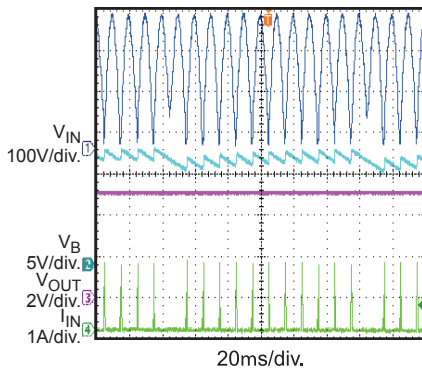

Input Power Shutdown
115Vac, 5V/60mA

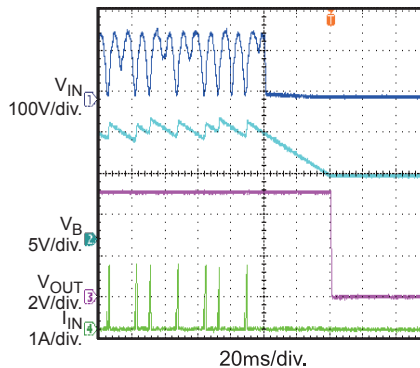

Input Power Shutdown
230Vac, 5V/60mA

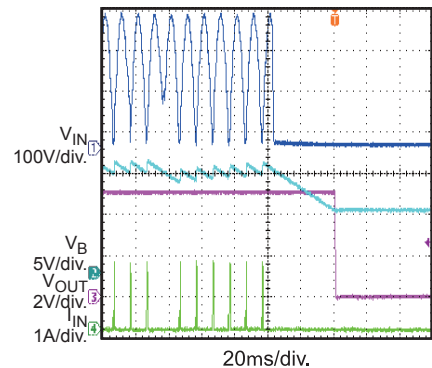

EVB TEST RESULTS (continued)

Performance waveforms are tested on the evaluation board.

 $V_{OUT} = 5V$, $I_{OUT} = 60mA$, $T_A = 25^{\circ}C$, unless otherwise noted.

Output Ripple

115Vac, 5V/60mA

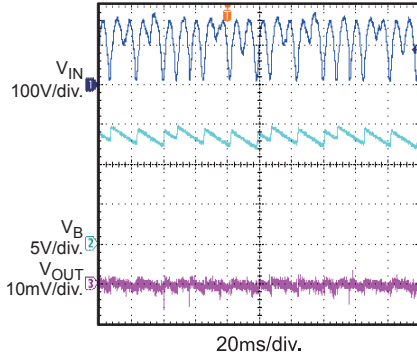
Output Ripple

230Vac, 5V/60mA

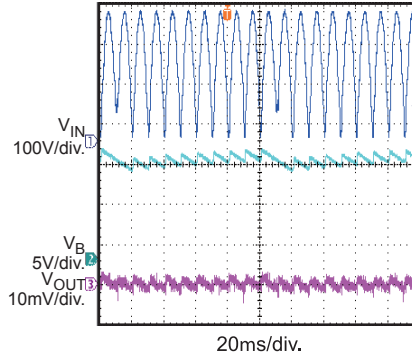
Load Transient

115Vac, 5V, 0 to 60mA

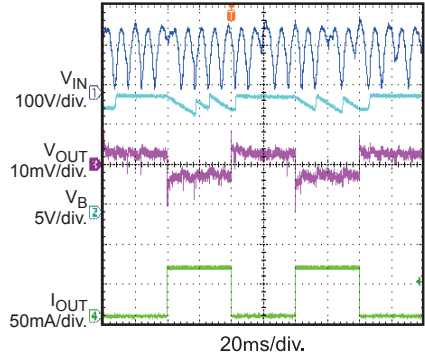
Load Transient

230Vac, 5V, 0 to 60mA

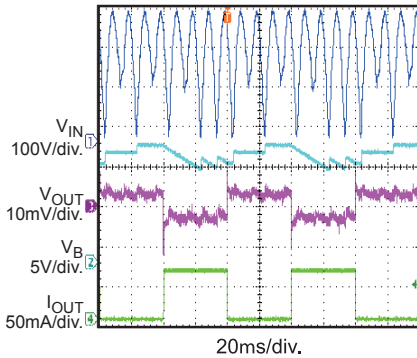
Over Load Protection Entry

115Vac

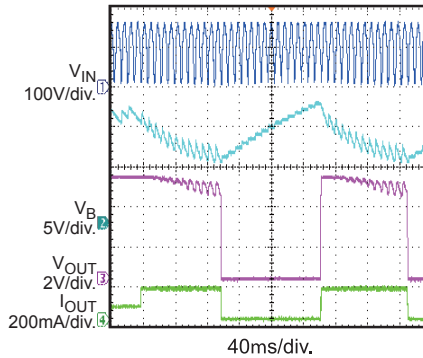
Over Load Protection Entry

230Vac

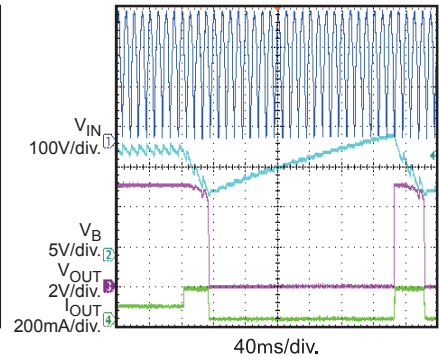
Over Load Protection Recovery

115Vac

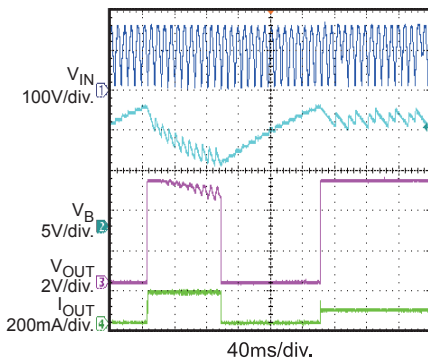
Over Load Protection Recovery

230Vac

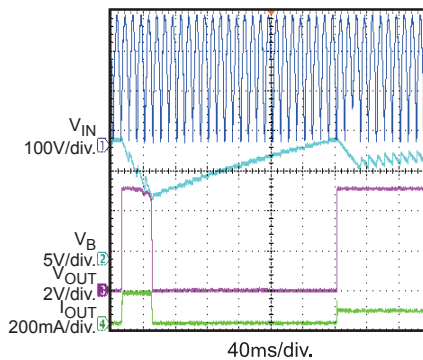
Short Circuit Protection Entry

115Vac

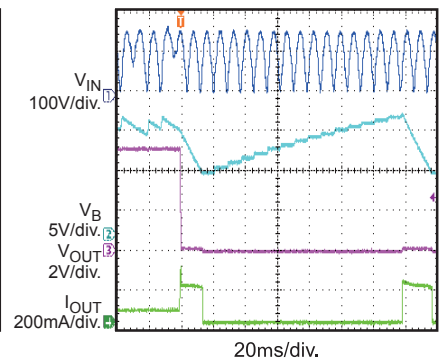

EVB TEST RESULTS *(continued)*

Performance waveforms are tested on the evaluation board.

$V_{OUT} = 5V$, $I_{OUT} = 60mA$, $T_A = 25^{\circ}C$, unless otherwise noted.

**Short Circuit
Protection Entry**
230Vac

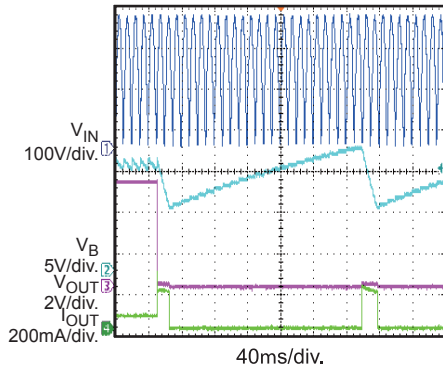

**Short Circuit
Protection Recovery**
115Vac

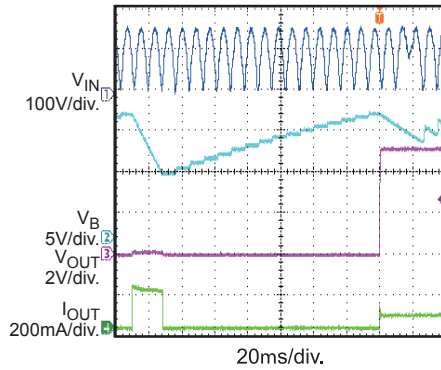

**Short Circuit
Protection Recovery**
230Vac

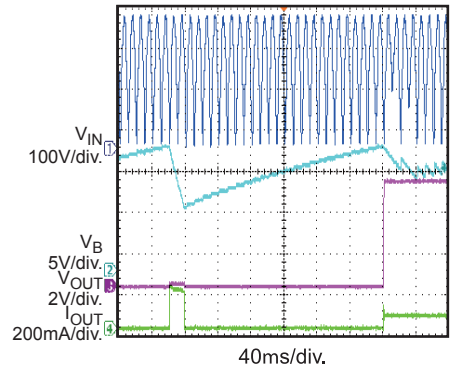

**VB Short to GND
Protection Entry**
115Vac

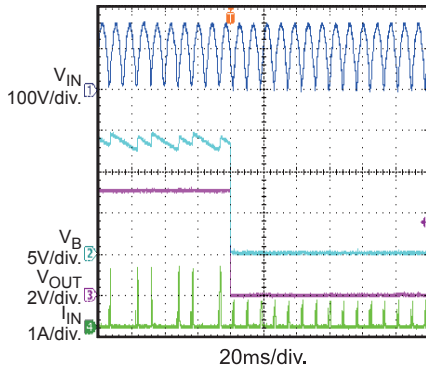

**VB Short to GND
Protection Entry**
230Vac

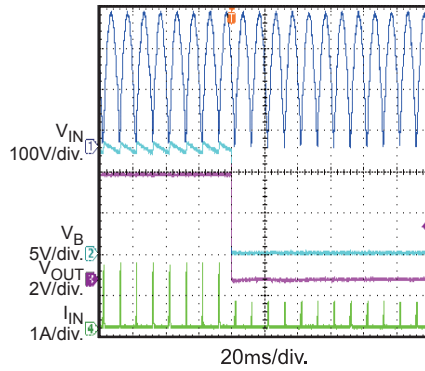

**VB Short to GND
Protection Recovery**
115Vac

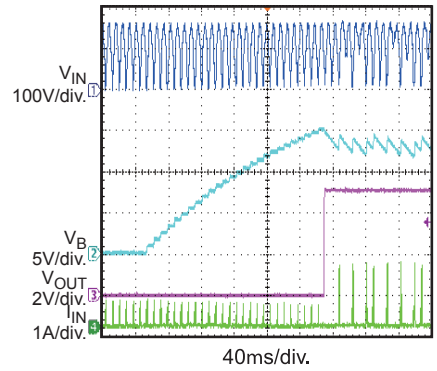

**VB Short to GND
Protection Recovery**
230Vac

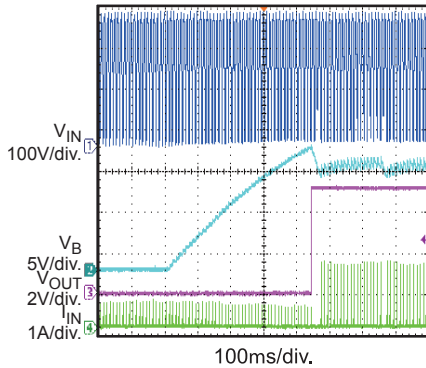

RT Protection Entry
115Vac

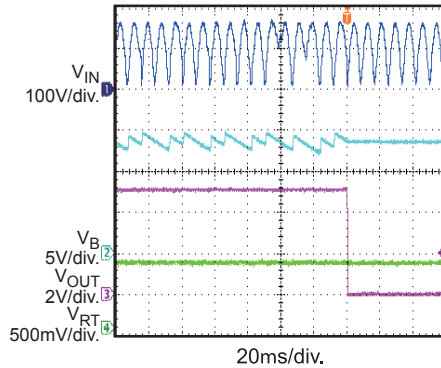

RT Protection Entry
230Vac

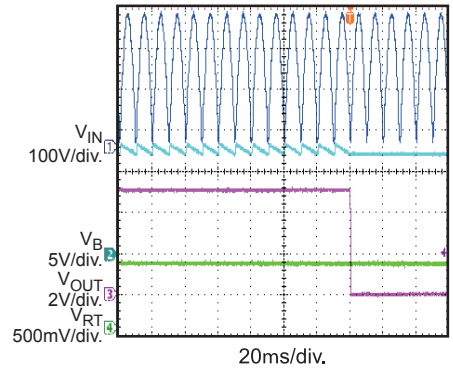

EVB TEST RESULTS *(continued)*

Performance waveforms are tested on the evaluation board.

$V_{OUT} = 5V$, $I_{OUT} = 60mA$, $T_A = 25^{\circ}C$, unless otherwise noted.

RT Protection Recovery
115Vac

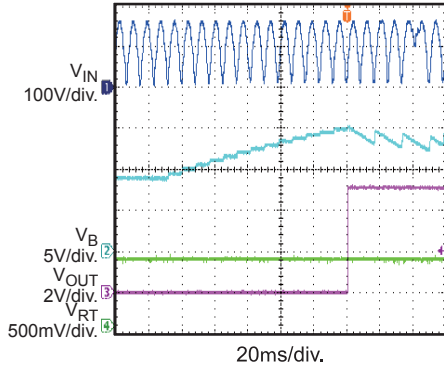

RT Protection Recovery
230Vac

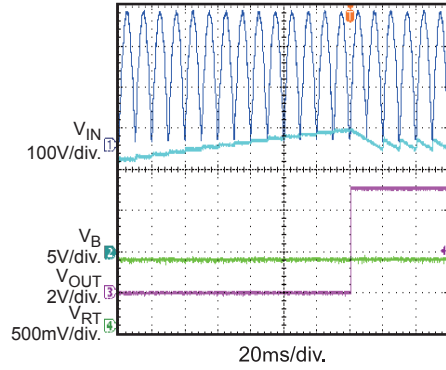

Thermal Shutdown Protection Entry
115Vac

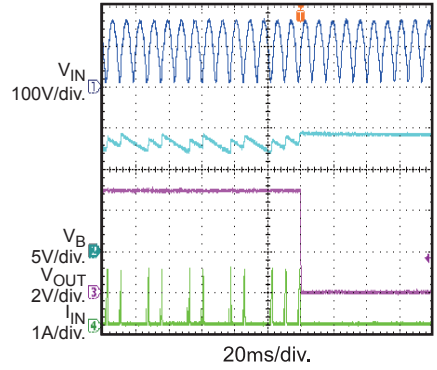

Thermal Shutdown Protection Entry
230Vac

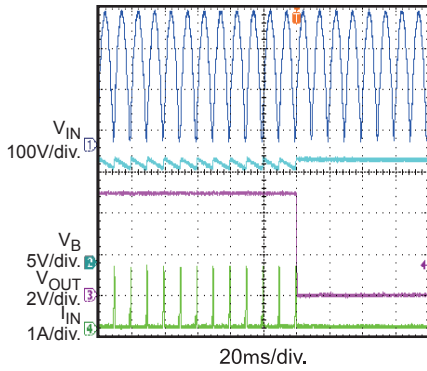

Thermal Shutdown Protection Recovery
115Vac

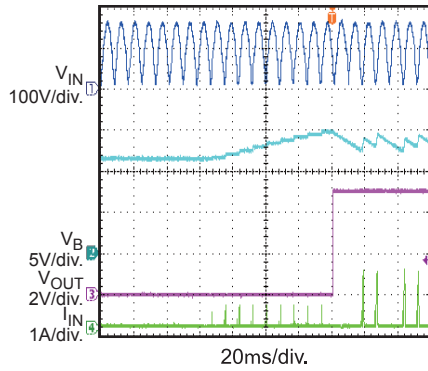

Thermal Shutdown Protection Recovery
230Vac

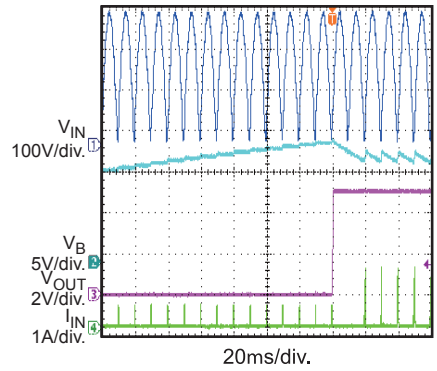

EVB TEST RESULTS *(continued)*

Performance waveforms are tested on the evaluation board.

$V_{OUT} = 5V$, $I_{OUT} = 60mA$, $T_A = 25^{\circ}C$, unless otherwise noted.

EMI Performance
115Vac, L Line

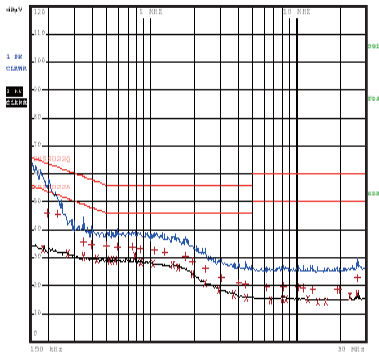

EMI Performance
115Vac, N Line

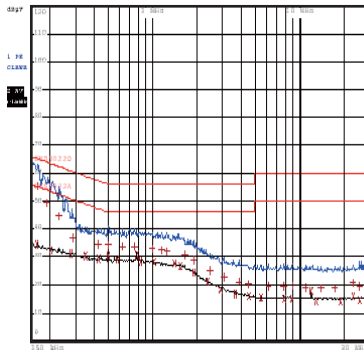

EMI Performance
230Vac, L Line

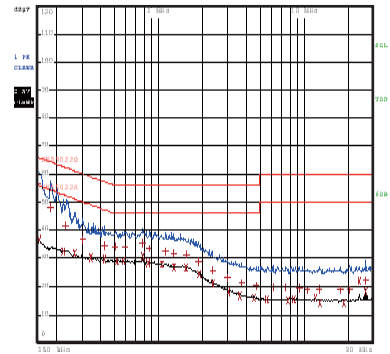

EMI Performance
230Vac, N Line

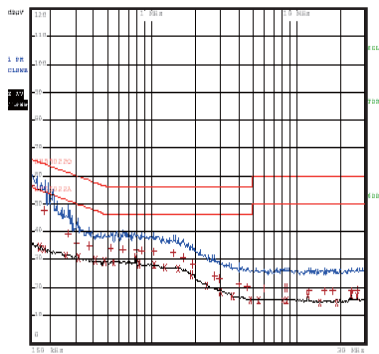

PRINTED CIRCUIT BOARD LAYOUT

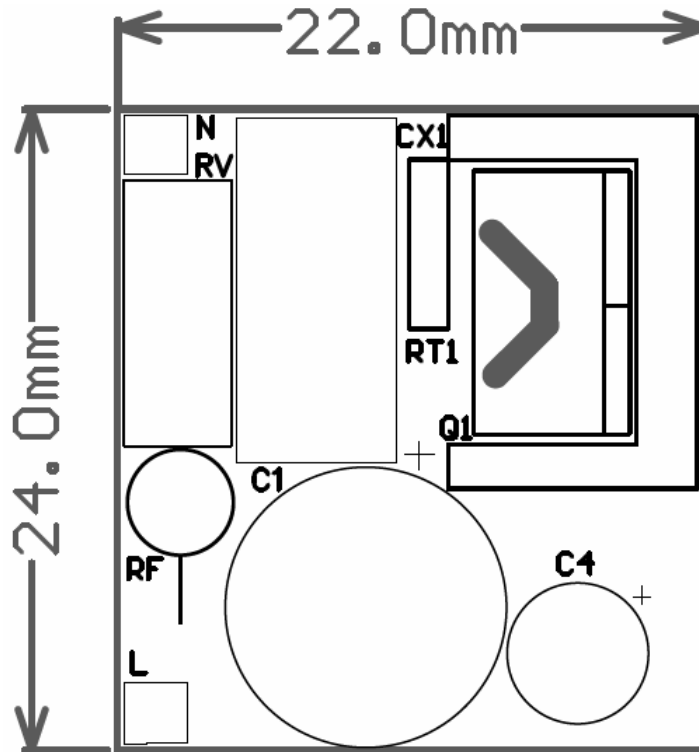

Figure 1 — Top Silk Layer

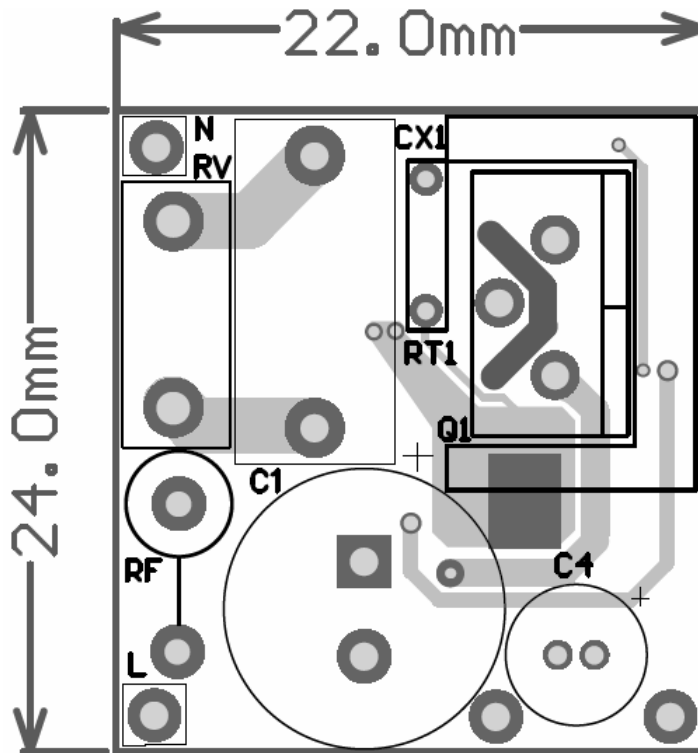

Figure 2 — Top Layer

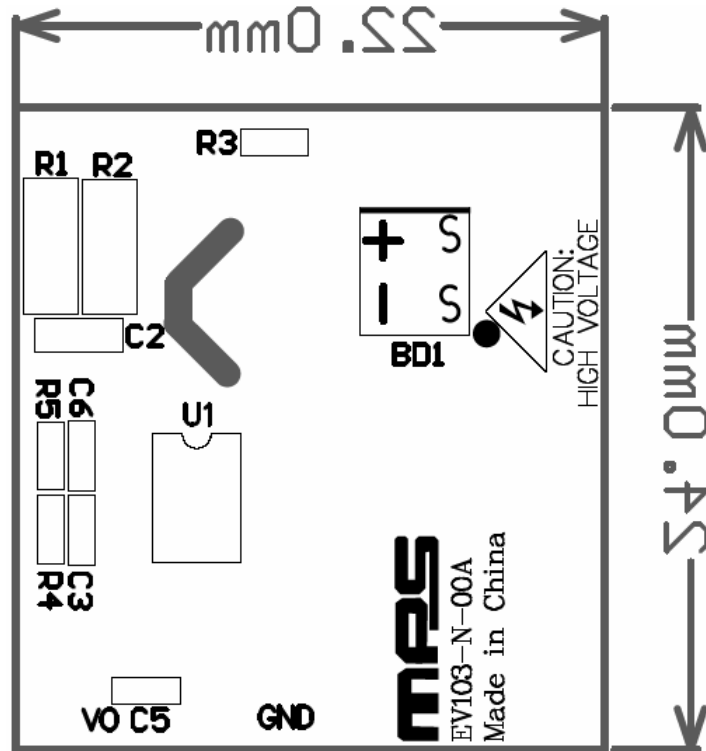

Figure 3 — Bottom Silk

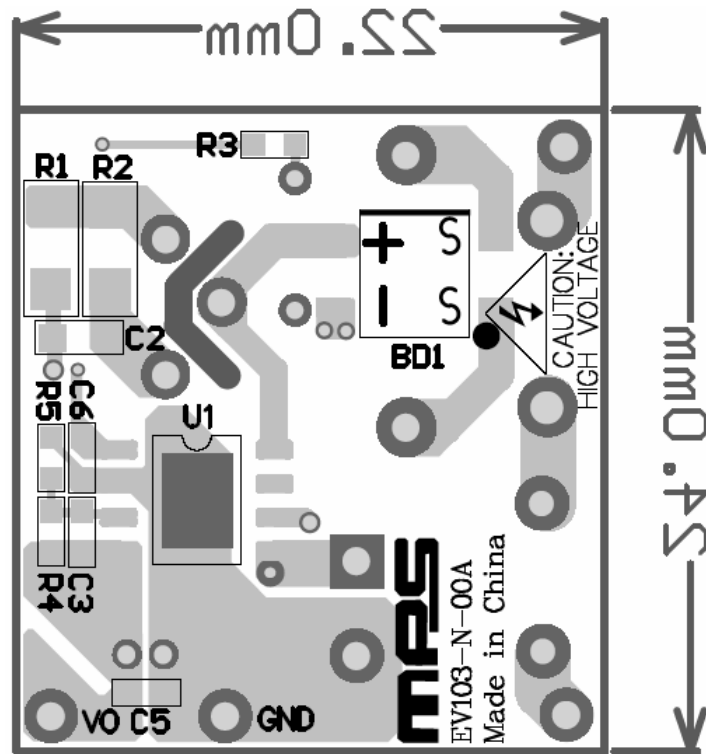

Figure 4 — Bottom Layer

QUICK START GUIDE

1. Preset Power Supply to $85V \leq V_{IN} \leq 265V$.
2. Turn Power Supply off.
3. Connect the Line and Neutral terminals of the power supply output to L and N ports.
4. Connect Load to VO and GND ports.
5. Turn Power Supply on after making connections.

NOTICE: The information in this document is subject to change without notice. Please contact MPS for current specifications. Users should warrant and guarantee that third party Intellectual Property rights are not infringed upon when integrating MPS products into any application. MPS will not assume any legal responsibility for any said applications.