



The Future of Analog IC Technology®

# EV024-10-S-00A

## Primary Side CC/CV Flyback Regulator Universal Input, 5V/2A USB Charger Evaluation Board

### DESCRIPTION

The MP024-10 is a low cost offline primary-side Flyback regulator with simple external circuit. It provides accurate constant voltage and constant current regulation without opto-coupler and secondary feedback circuit. And it has integrated 700V MOSFET and high-voltage start-up current source.

The MP024-10 operates in Discontinuous Conduction mode using variable off-time control. Its power-saving technologies limit the no-load power consumption to less than 30mW.

The MP024-10 also features complete protection functions such as VCC under-voltage lockout, over-current protection, over temperature protection, open loop protection and over voltage protection.

The MP024-10's variable switching frequency method provides natural spectrum shaping to smooth EMI signature, which suits for offline low power battery charger and adapter.

The MP024-10 is available in the SOIC8-7B package.

### ELECTRICAL SPECIFICATION

Parameter	Symbol	Value	Units
Input Voltage	$V_{IN}$	85 to 265	VAC
Output Voltage	$V_{OUT}$	5	V
Output Current	$I_{OUT}$	2	A
Output Power	$P_{OUT}$	10	W

### FEATURES

- Primary-Side–Control without Opto-Coupler and Secondary Feedback Circuit
- Precise Constant Current and Constant Voltage Control (CC/CV)
- Variable Off-Time Peak-Current Control
- 700V/4.5Ω Integrated MOSFET
- 700V High-Voltage Current Source
- 30mW No-Load Power Consumption
- Programmable Cable Compensation
- Multiple Protections: OVP, OCKP, SSP, OLP, TSD, and VCC UVLO
- Low Cost and Simple External Circuit
- Available in the SOIC8-7B Package

### APPLICATIONS

- Cell Phone Chargers
- Adapters for Handheld Electronics
- Stand-By and Auxiliary Power Supplies

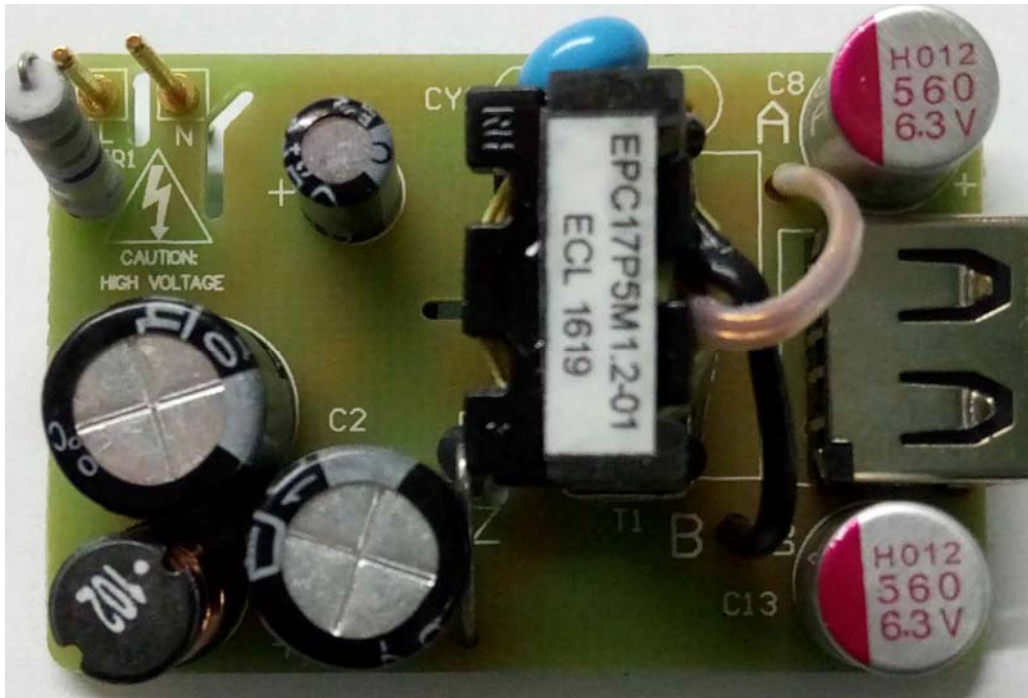
All MPS parts are lead-free, halogen-free, and adhere to the RoHS directive. For MPS green status, please visit MPS website under Quality Assurance. "MPS" and "The Future of Analog IC Technology", are Registered Trademarks of Monolithic Power Systems, Inc.



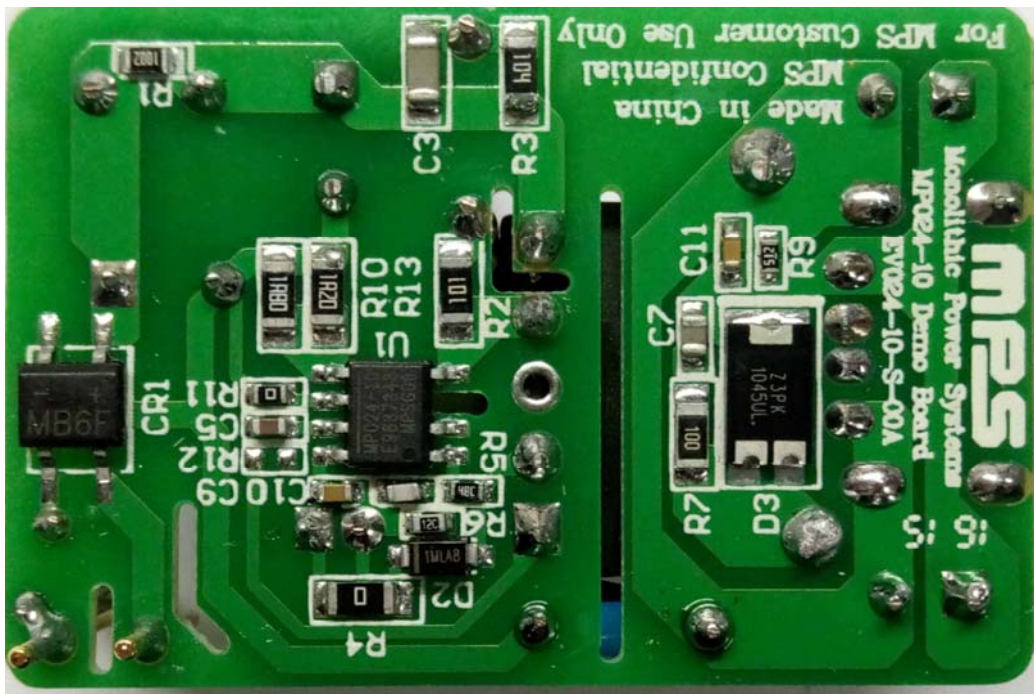
High Voltage

**Warning:** Although this board is designed to satisfy safety requirements, the engineering prototype has not been agency approved. Therefore, all testing should be performed using an isolation transformer to provide the AC input to the prototype board.

**EV024-10-S-00A EVALUATION BOARD**



**TOP VIEW**

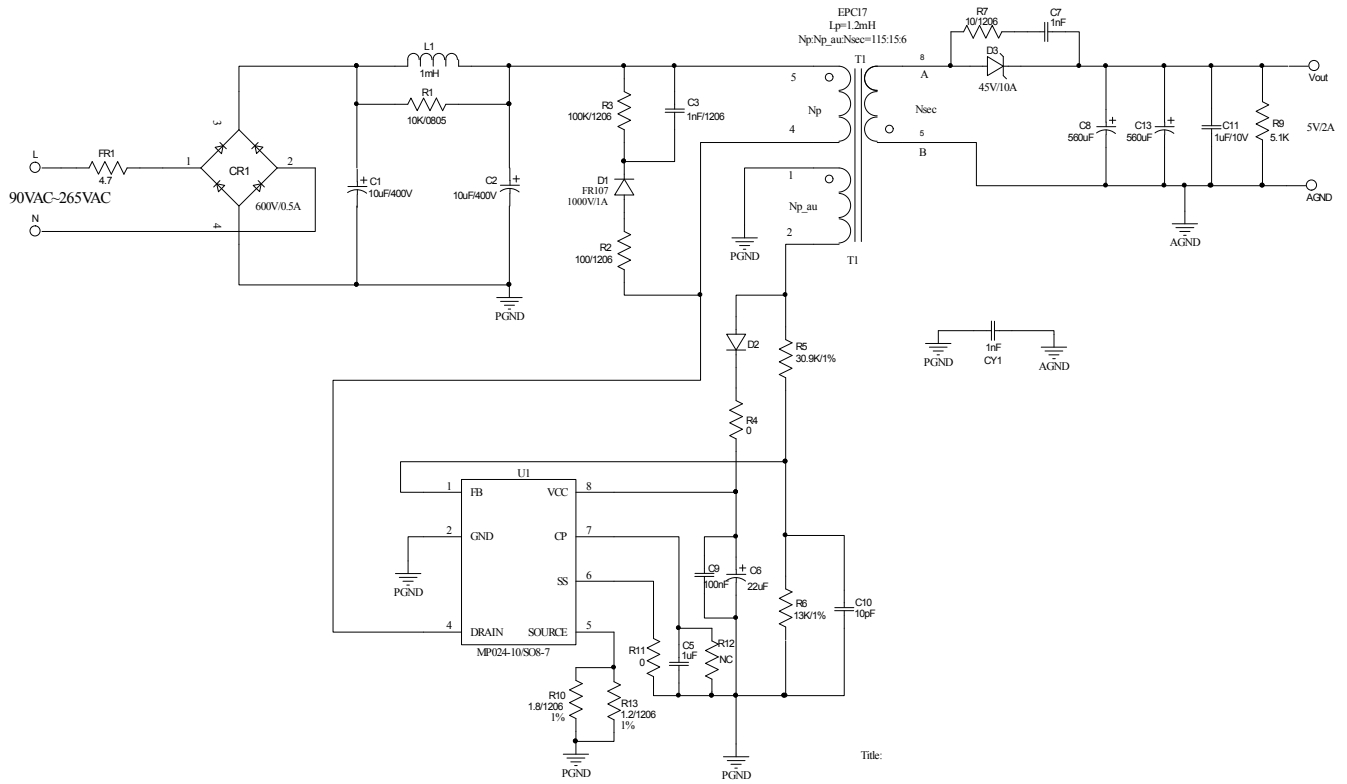


**BOTTOM VIEW**

(L x W x H) 48mm x 32mm x 17mm

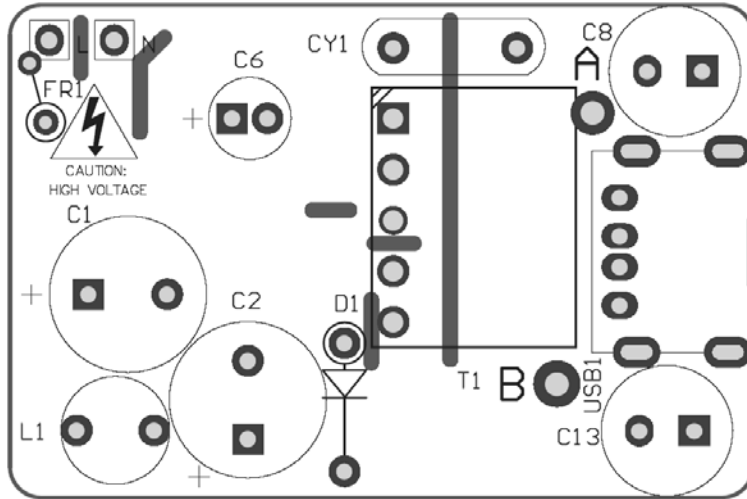
Board Number	MPS IC Number
EV024-10-S-00A	MP024GS-10

**EVALUATION BOARD SCHEMATIC**

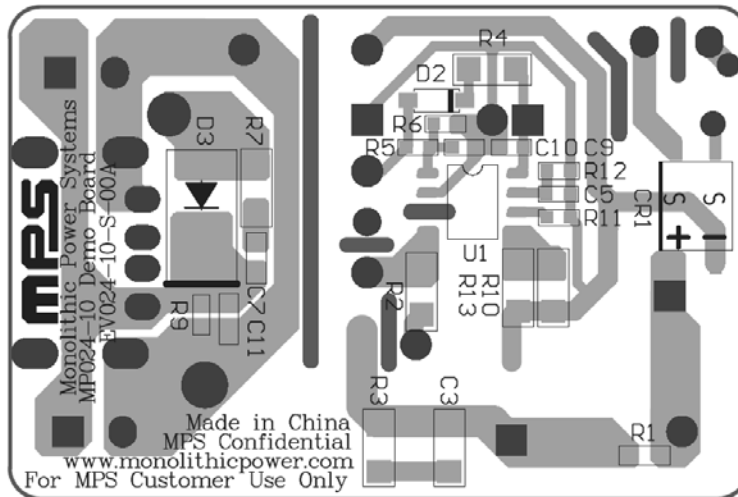


**Figure 1—Schematic**

**PCB LAYOUT (SINGLE-SIDED)**



**Figure 2—Top Layer**



**Figure 3—Bottom Layer**

## CIRCUIT DESCRIPTION

The EV024-10-S-00A is configured in a 5V/2A CC/CV output cell phone charger, it uses primary-side-control without opto-coupler which can mostly simplify the schematic and get a cost effective BOM.

FR1 is used to protect circuit from component failure or some excessive short events; also it can restrain the inrush current.

C1, L1 and C2 compose  $\pi$  filter to guarantee the conducted EMI meet standard EN55022.

R3, C3, and D1 compose primary side snubber. It absorbs the leakage inductance energy when MOSFET turns off to restrain the high spike. R2 is used in the snubber to damp the oscillation, which can couple to auxiliary winding and distort the FB detection.

D3 is output diode. Schottky diodes are recommended for their fast switching speed and low forward-voltage drop for better high or low temperature CV regulation and efficiency.

C7 and R7 compose the secondary side snubber. It restrains the high spike of D3.

R5 and R6 is the resistor divider for FB detection. For better application performance, select the resistor divider values from 10k $\Omega$  to 100k $\Omega$  to limit noise from adjacent components on FB.

T1 is power transformer. It should be designed properly to satisfy the power delivery and achieve good EMI.

C8 and C13 are output capacitors. They should be low ESR electrolytic capacitor for better output ripple and even better efficiency.

R9 is the dummy load. It is used for good no load regulation. If the dummy load is not used, the output voltage will run away under no load condition due to minimum switching frequency limitation.

**EV024-10-S-00A BILL OF MATERIALS**

Qty	RefDes	Value	Description	Package	Manufacturer	Manufacturer_P/N
2	C1, C2	10uF	Electrolytic Capacitor;400V	DIP	Chengxing	400V/10uF
1	C3	1nF	Ceramic Capacitor;630V;U2J	1206	Murata	GRM31A7U2J102JW31D
1	C5	1uF	Ceramic Capacitor;25V;X5R	0603	TDK	C1608X5R1E105K
1	C6	22uF	Electrolytic Capacitor;50V	DIP	江海	CD281L-50V22
1	C7	1nF	Capacitor;250V;X7R	0805	TDK	C2012X7R2E102K
2	C8, C13	560uF	Electrolytic Capacitor;6.3V	DIP	江海	HEN0J561MB12
1	C9	100nF	Ceramic Capacitor;50V;X7R	0603	muRata	GRM188R71H104KA93D
1	C10	10pF	Ceramic Capacitor;50V;C0G	0603	muRata	GRM1885C1H100JA01
1	C11	1uF/10V	Ceramic Capacitor;10V;X7R	0603	Murata	GRM188R71A105KA61D
1	CR1	MB6F	Diode;600V;0.5A	SOP-4	Bangdayuan	MB6F
1	CY1	1nF	Y Capacitor;250V;20%	DIP	鸿科	JYK08F102ML72N
1	D1	FR107	Diode;1000V;1A	DO-41	Diodes	FR107
1	D2	S1ML	Diode;1000V;1.0A	SOD-123	Taiwan Semi	S1ML
1	D3	Z3PK1045LH	Diode;45V;10A	Z3PK	Maxmega	PDS760
1	FR1	4.7	Resistor;5%;1W	DIP	Yageo	FKN1WSJT-52-4R7
1	L1	1mH	Inductor;1mH;420mA	DIP	Wurth	7447462102
1	R1	10K	Film Resistor;1%	0805	Yageo	RC0805FR-0710KL
1	R2	100	Film Resistor;5%;1/4W	1206	Yageo	RC1206JR-07100RL
1	R3	100K	Film Resistor;5%	1206	Yageo	RC1206JR-07100KL
1	R4	0	Film Resistor;5%	1206	Yageo	RC1206JR-070R
1	R7	10	Film Resistor;5%	1206	Yageo	RC1206JR-0710R
1	R5	30.9K	Film Resistor;1%;	0603	Yageo	RC0603FR-0730K9L
1	R6	13K	Film Resistor;1%	0603	Yageo	RC0603FR-0713KL
1	R9	5.1K	Film Resistor;1%	0603	Yageo	RC0603FR-075K1L
1	R10	1.8	Film Resistor;1%;1/4W	1206	Yageo	RC1206FR-071R8L
1	R11	0	Film Resistor;5%	0603	Yageo	RC0603JR-070RL
0	R12	NC	No Connected			
1	R13	1.2	Film Resistor;1%;1/4W	1206	Yageo	RC1206FR-071R2L
1	T1		Transformer, Lm=1.2mH	EPC17 Vertical	Emei(1)	FX0444
1	U1	MP024-10	Primary Side Flyback Regulator	SOIC8-7	MPS	MP024-10
1	USB1		USB Output Port		Any	
Notes:		(1) Emei transformer sample request please log on website: <a href="http://www.emeigroup.com">www.emeigroup.com</a>				

## TRANSFORMER SPECIFICATION

### Basic Characteristics

Parameter	Value
Core	EPC17
Bobbin	EPC17 Vertical, 5+0 Pin
Primary Inductance	1.2mH
Core Material	PC40 or equivalent
Turn Ratio	$N_P:N_S:N_{P\_AUX}:N_C=115:6:15:18$

### Electrical Diagram

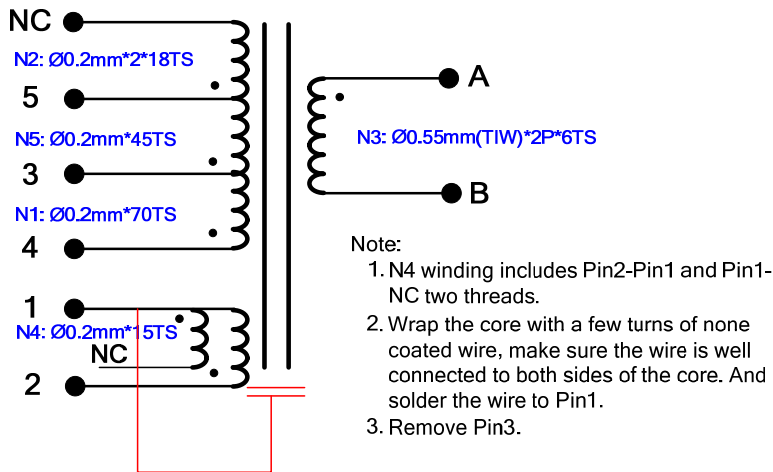


Figure 4—Transformer Electrical Diagram

### Winding Diagram

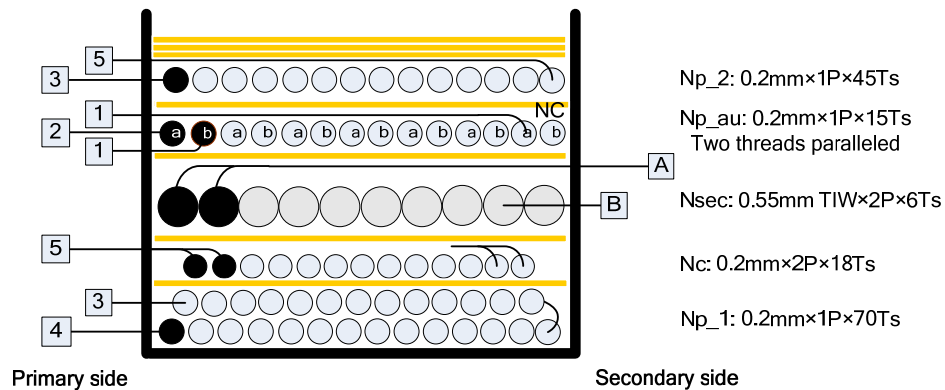


Figure 5—Winding Diagram

### Winding Order

Tapes (T)	Winding	Start-End	Wire Diameter (Ø)	Turns ( T )
0	N1	4→3	0.2*1	70
1	N2	5→NC	0.2*2	18
1	N3	A→B	0.55*2 TIW	6
1	N4	2→1	0.2*1	15
		1→NC	0.2*1	
1	N5	3→5	0.2*1	45

### Electrical Specifications

<b>Electrical Strength</b>	60 seconds 60Hz, from PRI. to SEC.	3500VAC
	60 seconds 60Hz, from PRI. to CORE	1500VAC
	60 seconds 60Hz, from SEC. to CORE.	1500VAC
	60 seconds 60Hz, from N1 to N4.	500VAC
<b>Primary Inductance</b>	Pins 4 - 5, all other windings open, measured at 60kHz, 0.1 VRMS	1.2mH±10%

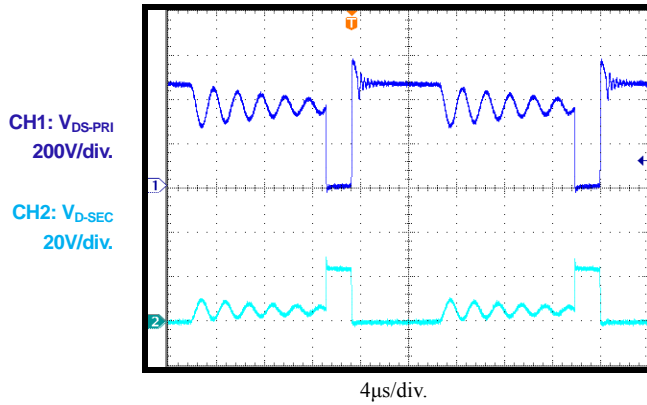


## EVB TEST RESULTS

$V_{IN} = 230V_{AC}$ ,  $V_{OUT} = 5V$ ,  $I_{OUT} = 2A$ ,  $T_A = 25^{\circ}C$ , unless otherwise noted.

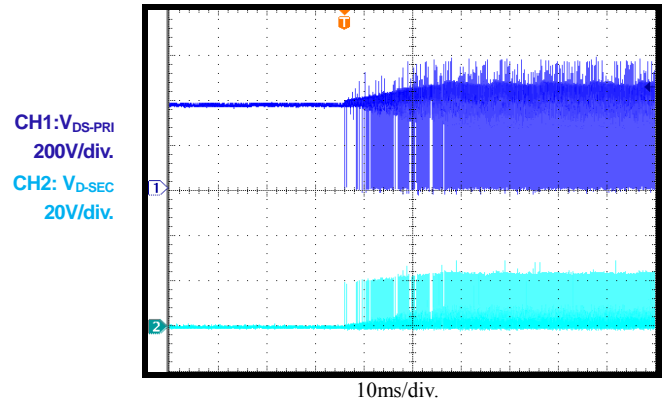
### Steady State

$V_{IN} = 265V_{AC}$

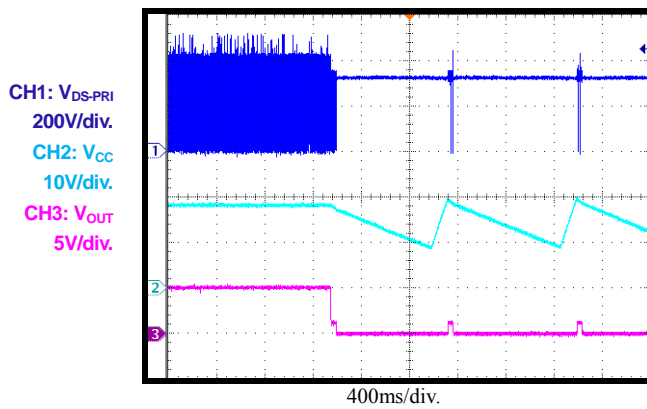


### Power On

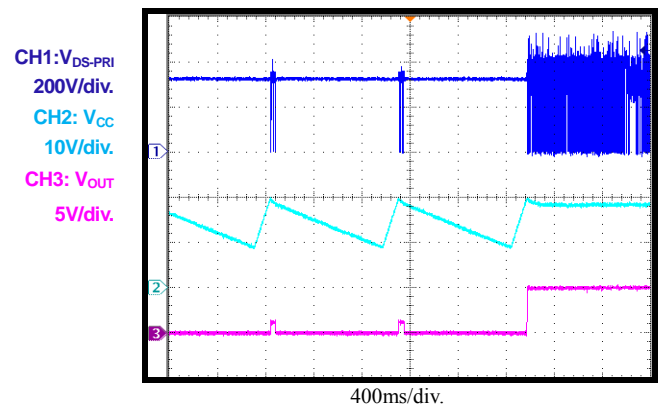
$V_{IN} = 265V_{AC}$



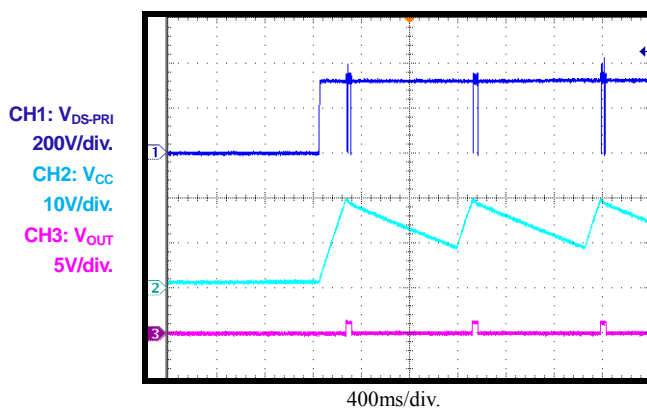
### OLP Entry



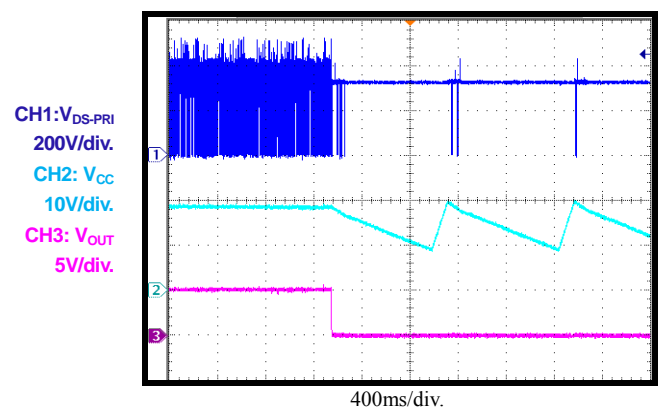
### OLP Recovery



### OLP Power On



### Short Circuit Entry

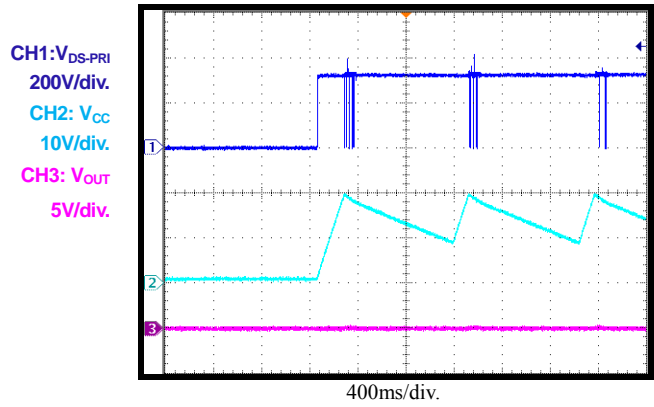
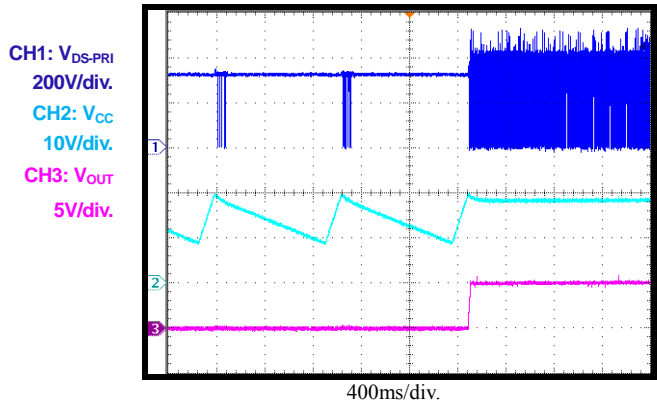


**EVB TEST RESULTS** (continued)

$V_{IN} = 230V_{AC}$ ,  $V_{OUT} = 5V$ ,  $I_{OUT} = 2A$ ,  $T_A = 25^{\circ}C$ , unless otherwise noted.

**Short Circuit Recovery**

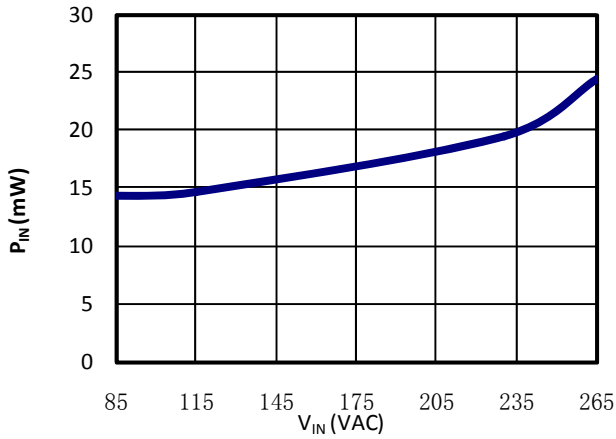
**Short Circuit Power On**



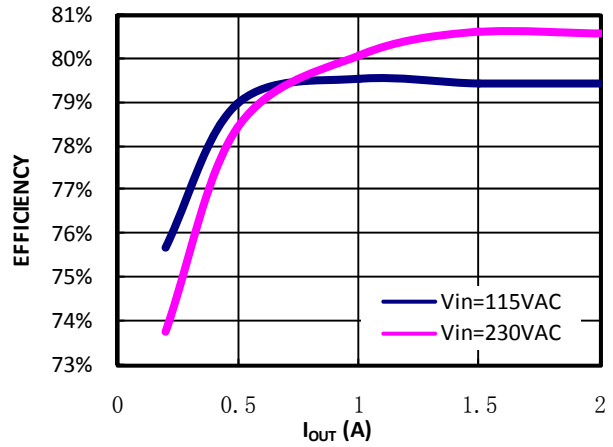
**EVB TEST RESULTS** (continued)

$V_{IN} = 230V_{AC}$ ,  $V_{OUT} = 5V$ ,  $I_{OUT} = 2A$ ,  $T_A = 25^{\circ}C$ , unless otherwise noted.

No Load Consumption

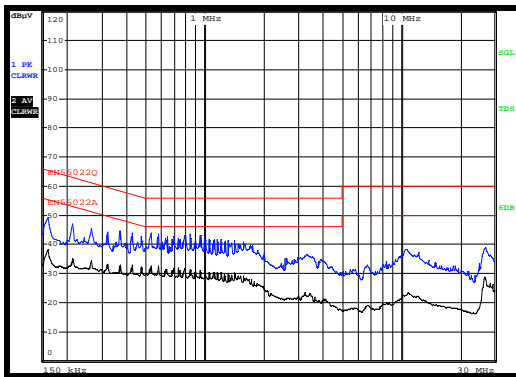


Efficiency



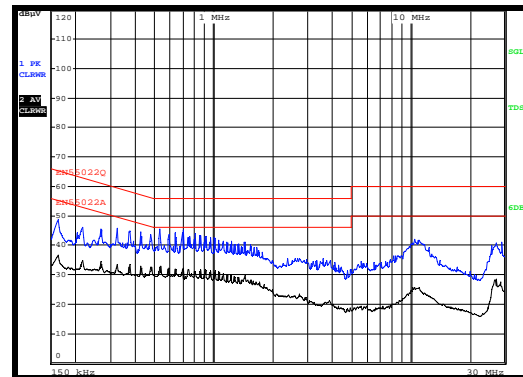
Conducted EMI

V<sub>IN</sub>=115VAC, L Line



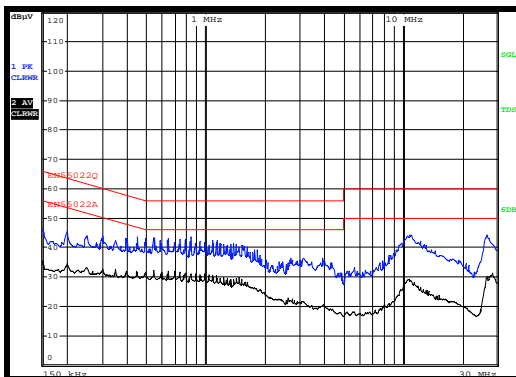
Conducted EMI

V<sub>IN</sub>=115VAC, N Line



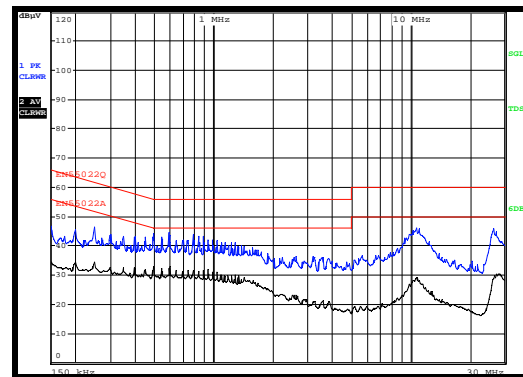
Conducted EMI

V<sub>IN</sub>=230VAC, L Line



Conducted EMI

V<sub>IN</sub>=230VAC, N Line



## QUICK START GUIDE

1. Preset Power Supply to  $85\text{VAC} \leq V_{\text{IN}} \leq 265\text{VAC}$ .
2. Turn Power Supply off.
3. Connect the Line and Neutral terminals of the power supply output to L and N port.
4. Connect load with a USB port.
5. Turn Power Supply on after making connections.

**NOTICE:** The information in this document is subject to change without notice. Please contact MPS for current specifications. Users should warrant and guarantee that third party Intellectual Property rights are not infringed upon when integrating MPS products into any application. MPS will not assume any legal responsibility for any said applications.