

PRELIMINARY SPECIFICATIONS SUBJECT TO CHANGE

FEATURES

The **MSM957094-36** is part of a family of fully integrated smart motor solutions for servo motor applications. This 57mm (NEMA 23), 94W power motor integrates a brushless DC motor and driver module. The user can choose from one of three options: speed control mode, position control mode, or speed/position control mode. Two control interface options are available: an RS485 interface or a PULSE/DIR interface.

Easy-to-use GUI software provides flexibility as it allows users to optimize the design online through the RS485 control interface. The parameters are saved in the motor's non-volatile memory. A design guide for the GUI is available for download at www.monolithicpower.com

In addition to the fully integrated smart motor solutions, the driver modules can be ordered separately for customization into different motor types. The **MMP757094-36** is the driver module part number.

A datasheet for the MMP757094-36 is available for download at www.monolithicpower.com.

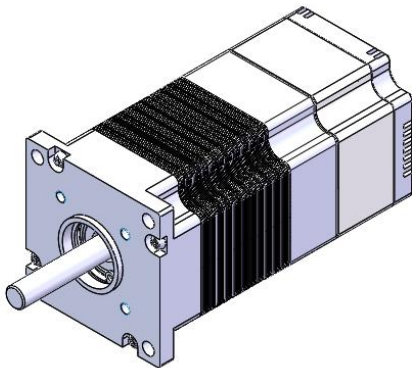

DESCRIPTION

- 18V to 70V Input Voltage Range
- Max. 94W Continuous Power Output
- 0.3N-m Rated Torque (0.9N-m Peak Torque)
- 0.3° Position Resolution
- RS485 Interface and PULSE/DIR Interface
- Position Control and Speed Control
- Operating Temperature: 0°C - 70°C (Power Derated > 40°C)
- Storage Temperature: -40°C - 125°C

ORDERING INFORMATION

Part Number	Diameter (mm)	Power (W)	Typical Voltage (V)	Control Mode	Interface
MSM957094-36-S-R	57	94	36	Speed	RS485
MSM957094-36-P-R	57	94	36	Position	RS485
MSM957094-36-C-R	57	94	36	Speed /Position	RS485
MSM957094-36-P-D	57	94	36	Position	Pulse/Dir

To evaluate the smart motor, an evaluation kit can be ordered from monolithicpower.com

Evaluation Kit EVKT-957094-36

#	Part Number	Item	Quantity
1	MSM957094-36-X-X	Smart Motor	1
2	eMotion Control System Communication Kit	USB Dongle with Cable	1
3	TDRIVE-957094	USB Flash Drive with GUI Installation Document	1

SMART MOTOR SPECIFICATIONS

Smart Motor			
Parameters	Condition	Value	Units
Input Voltage		36	V
Output Power	0°C - 40°C	94	W
Position Resolution		0.3	°
Nominal Speed		3000	RPM
Nominal Torque		0.3	N-m
Rotor Inertia		210	g-cm ²
Diameter		57	mm
Shaft Diameter		8	mm
Length	Body Only	76	mm
Weight		900	g

RECOMMENDED OPERATION CONDITIONS

Input voltage18V -70V
 Control interface voltage0V-5.5V
 Max. pulse frequency 500kHz
 RS485 A/B voltage0V-5.5V
 RS485 common mode voltage +/-15V
 Operation temperature 0°C - 70°C
 Storage temperature -40°C - 125°C

HARDWARE CONNECTION FOR SMART MOTOR

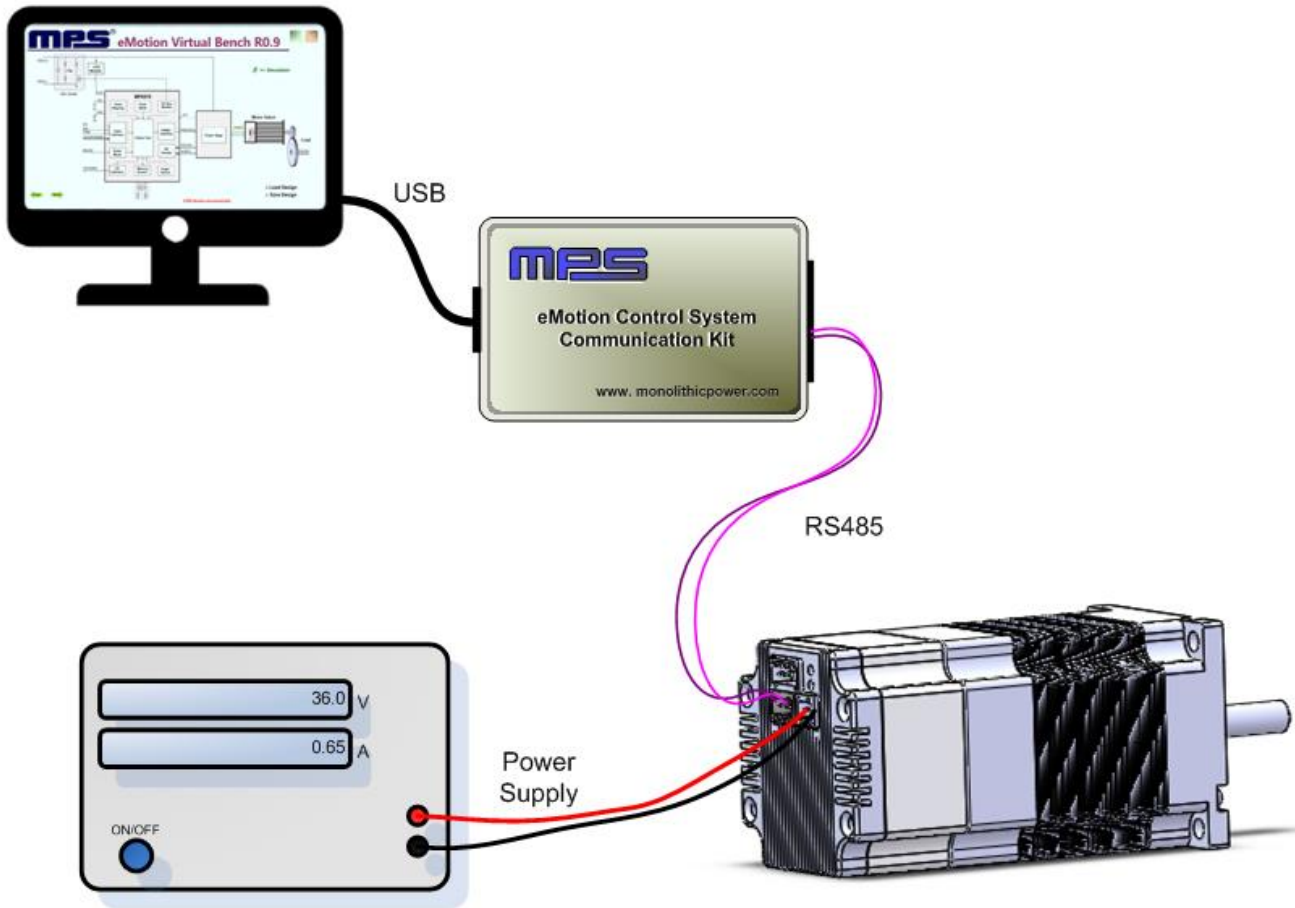

PIN CONFIGURATION

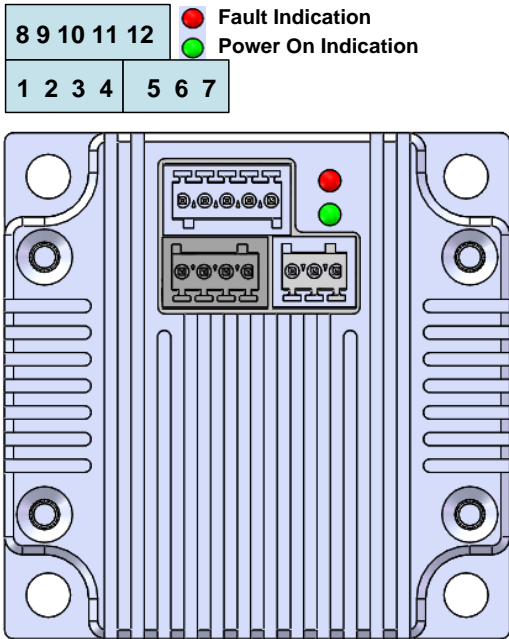

Pin Number	Designation	Pin Description
RS485 Interface		
1	EXT_5V	5V Input For Firmware Programming
2	B	RS485 Node B
3	AGND	RS485 Ground
4	A	RS485 Node A
Power Interface		
5	GND	Power Ground
6	R-	Shunt Resistor Return Node
7	VIN	Input Power Supply
Control Interface		
8	COM-	Common Return
9	EN+	Enable Input
10	PEND+	Position End Output
11	PUL+	Pulse Input
12	DIR+	Direction Input

TYPICAL PERFORMANCE CHARACTERISTICS

T_A=25°C, VIN=36V, unless otherwise noted

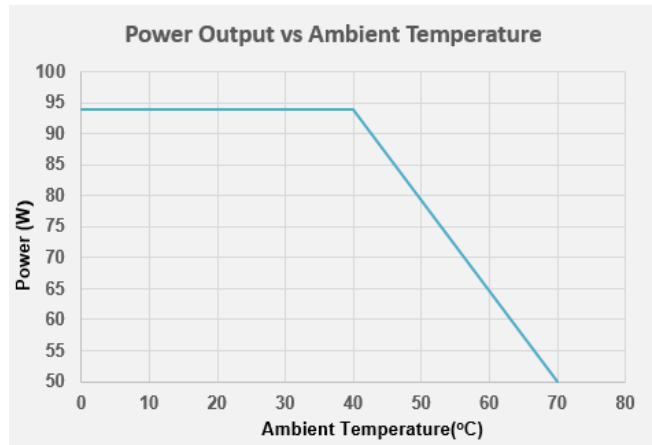
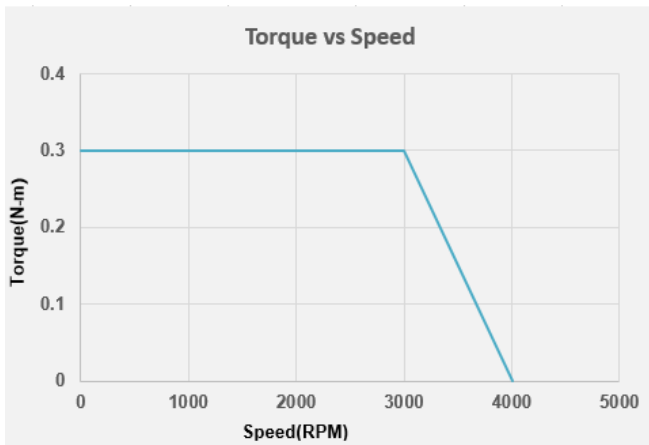

SMART MOTOR MECHANICAL DRAWING

