

DESCRIPTION

The MPQ3426 is a current-mode step-up converter with a 6A, 90mΩ internal switch that provides a highly efficient regulator with a fast response. The MPQ3426 features a programmable frequency of up to 2MHz that allows for easy filtering and reduces noise. An external compensation pin gives the user flexibility in setting loop dynamics, and uses small, low-ESR, ceramic output capacitors. Soft-start results in a small inrush current and can be programmed with an external capacitor. The MPQ3426 operates from an input voltage as low as 3.2V and can generate up to a 35V output.

The MPQ3426's features include under-voltage lockout, current limiting, and thermal overload protection. The MPQ3426 is available in a low profile 14-pin 3mm×4mm QFN package with an exposed pad.

FEATURES

- 6A, 90mΩ, 45V Power MOSFET
- Uses Very Small Capacitors and Inductors
- Wide Input Range: 3.2V to 22V
- Output Voltage as High as 35V
- Programmable f_{sw} : 300kHz to 2MHz
- Programmable UVLO, Soft-Start, UVLO Hysteresis
- Micropower Shutdown <1μA
- Thermal Shutdown 160°C
- Available in 14-Pin 3mm×4mm QFN Package

APPLICATIONS

- Telecom—Power Supplies
- Audio—Microphone and Tuner Bias
- Automotive

All MPS parts are lead-free and adhere to the RoHS directive. For MPS green status, please visit MPS website under Quality Assurance. MPS[®] and "The Future of Analog IC Technology" are Registered Trademarks of Monolithic Power Systems, Inc.

ELECTRICAL SPECIFICATIONS

| Parameter | Symbol | Value | Units |
|----------------|-----------|-------|-------|
| Input Voltage | V_{IN} | 6-9 | V |
| Output Voltage | V_{OUT} | 12 | V |
| Output Current | I_{OUT} | 2 | A |

EVQ3426-L-00A EVALUATION BOARD



(L x W x H) 2.5" x 2.5" x 0.4"
(6.35cm x 6.35cm x 1.0cm)

| Board Number | IC Number |
|---------------|-----------|
| EVQ3426-L-00A | MPQ3426DL |

Efficiency

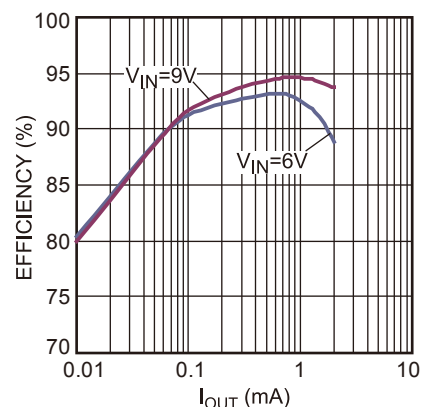

EVALUATION BOARD SCHEMATIC

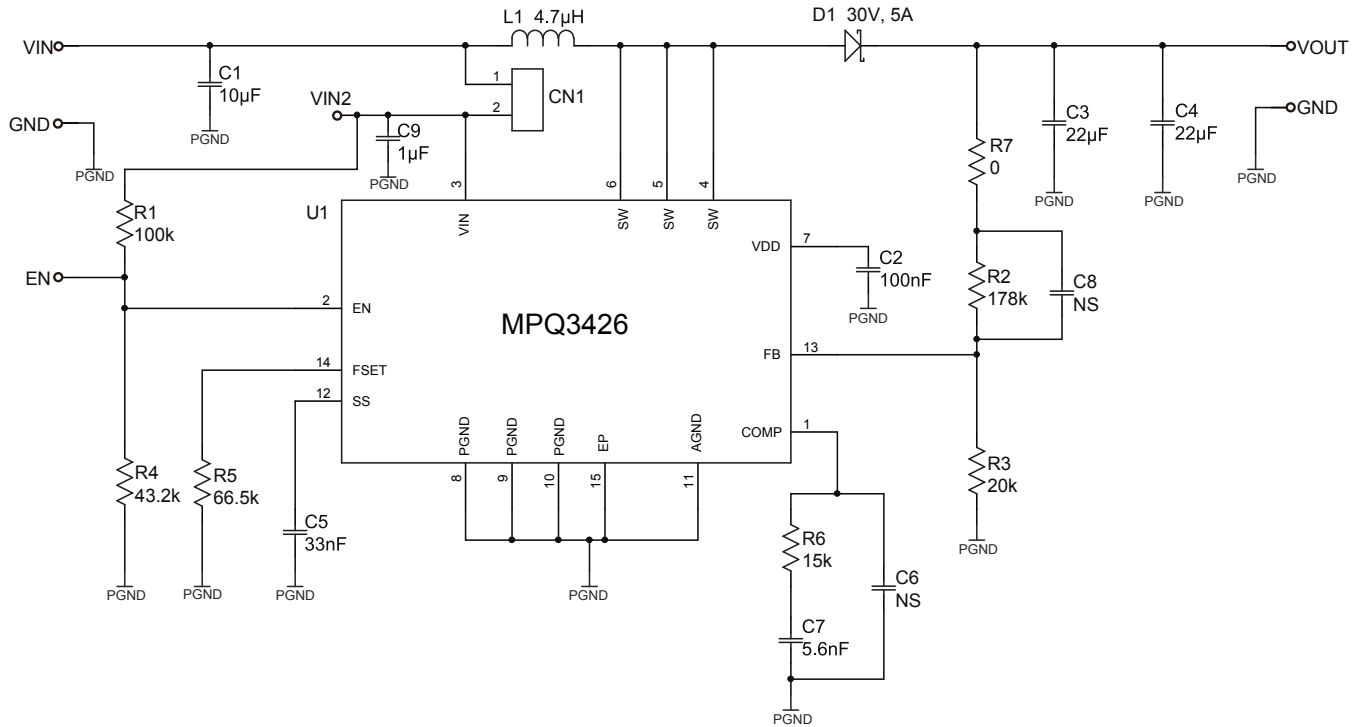

EVQ3426-L-00A BILL OF MATERIALS

| Qty | Ref | Value | Description | Package | Manufacturer | Manufacturer P/N |
|-----|-------|---------|----------------------------------|---------|--------------|--------------------|
| 1 | R1 | 100k | Film Res,5% | 0603 | ROYAL | RL0603FR-07100KL |
| 1 | R2 | 178k | Film Res,1% | 0603 | ROYAL | RL0603FR-07178KL |
| 1 | R3 | 20k | Film Res,1% | 0603 | ROYAL | RL0603FR-0720KL |
| 1 | R4 | 43.2k | Film Res,5% | 0603 | ROYAL | RC0603FR-0743K2L |
| 1 | R5 | 66.5k | Film Res,1% | 0603 | ROYAL | RC0603FR-0766K5L |
| 1 | R6 | 15k | Film Res,5% | 0603 | ROYAL | RL0603FR-0715KL |
| 1 | R7 | 0 | Film Res,5% | 0603 | ROYAL | RC0603FR-070RL |
| 1 | C1 | 10µF | Ceramic Cap,25V,X7R | 1210 | muRata | GRM32DR71E106KA12L |
| 1 | C2 | 0.1µF | Ceramic Cap,16V,X7R | 0805 | muRata | GRM219R71C104KA01D |
| 2 | C3,C4 | 22µF | Ceramic Cap,25V,X7R | 1210 | muRata | GRM32ER71E226KE15L |
| 1 | C5 | 33nF | Ceramic Cap,50V,X7R | 0603 | TDK | C1608X7R1H333K |
| 1 | C6,C8 | NC | | | | |
| 1 | C7 | 5.6nF | Ceramic Cap,50V,X7R | 0603 | muRata | GRM188R71H562KA01D |
| 1 | C9 | 1.0µF | Ceramic Cap,25V,X5R | 0805 | muRata | GRM216R61E105KA12D |
| 1 | L1 | 4.7µH | IR=15.5A, Isat=17A, Rdc=6.35mOhm | | Würth | 744 332 047 0 |
| 1 | D1 | SS5P3 | Schottky diode 30V 5A | TO-277A | Vishay | SS5P3 |
| 1 | U1 | MPQ3426 | Boost converter | QFN | MPS | MPQ3426 |

EVB TEST RESULTS

Performance waveforms are tested on the evaluation board.

Efficiency

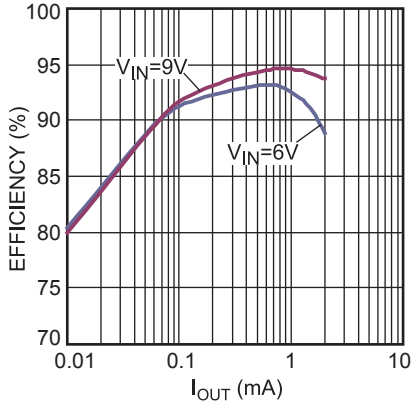

Line Regulation

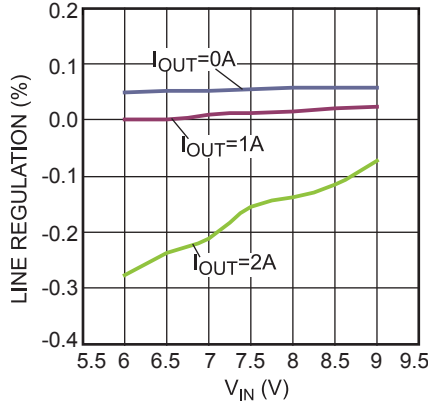

Load Regulation

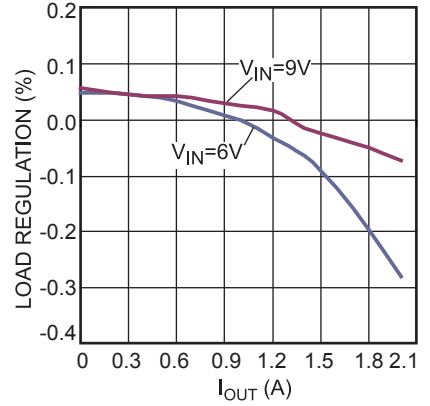

Case Temperature Rising vs. Load Current

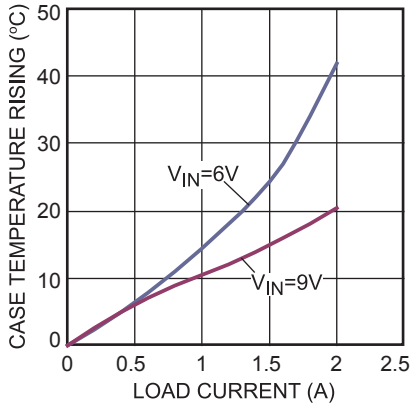

V_{FB} Voltage vs. T_A

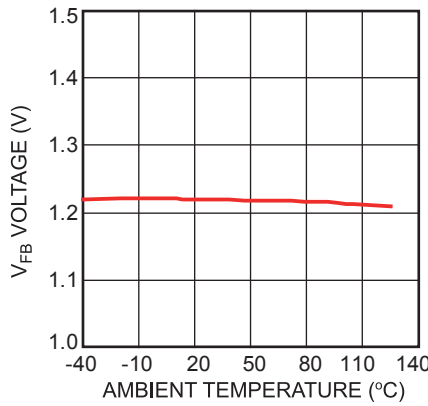

I_Q Current vs. T_A

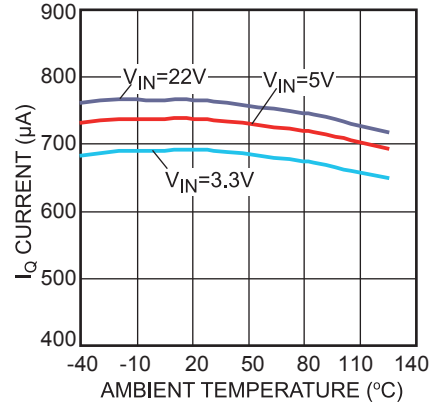

Current Limit vs. T_A

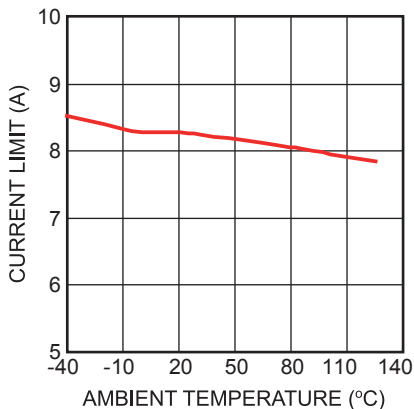

V_{IN} UVLO Voltage vs. T_A

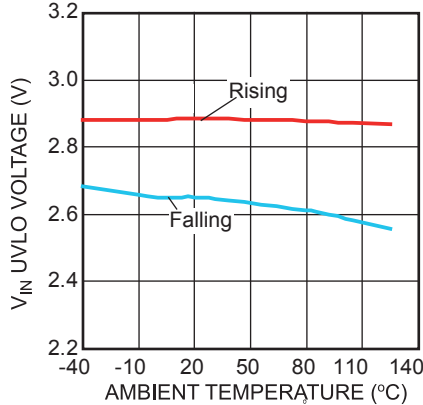

F_{SW} Frequency vs. T_A

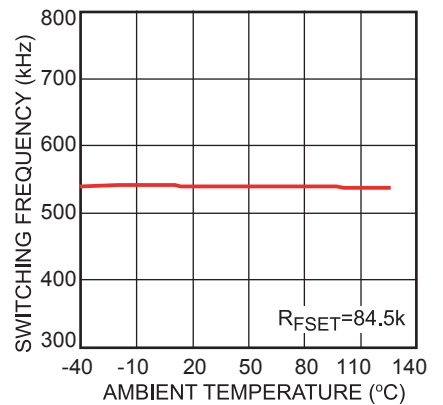

EVB TEST RESULTS (continued)

Performance waveforms are tested on the evaluation board.

Steady State

$V_{IN} = 6V, V_{OUT} = 12V/0A$

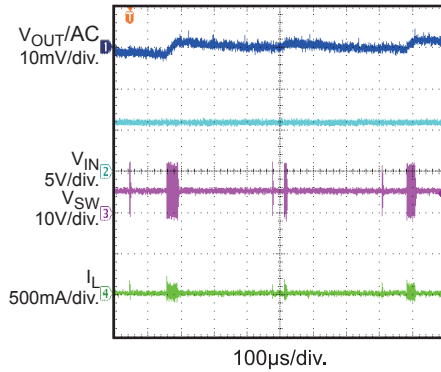

Steady State

$V_{IN} = 6V, V_{OUT} = 12V/2A$

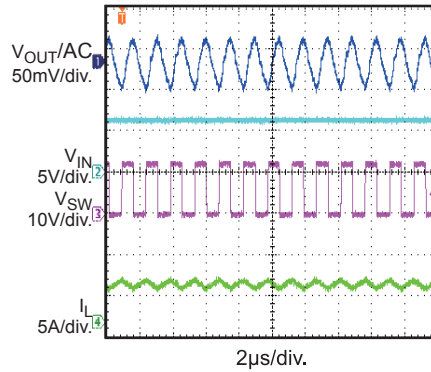

V_{IN} Start Up

$V_{IN} = 6V, V_{OUT} = 12V/0A$

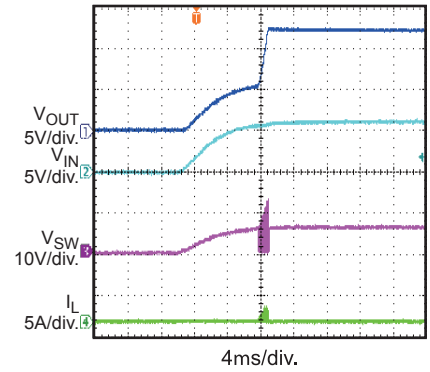

V_{IN} Start Up

$V_{IN} = 6V, V_{OUT} = 12V/2A$

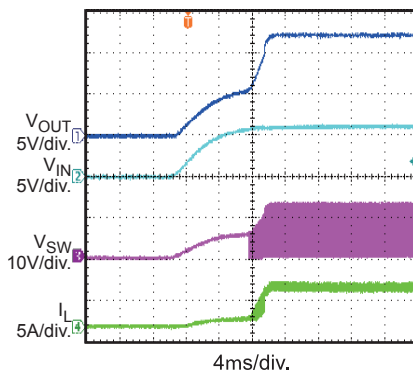

V_{IN} Shutdown

$V_{IN} = 6V, V_{OUT} = 12V/0A$

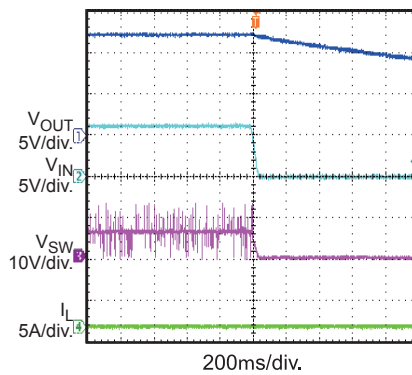

V_{IN} Shutdown

$V_{IN} = 6V, V_{OUT} = 12V/2A$

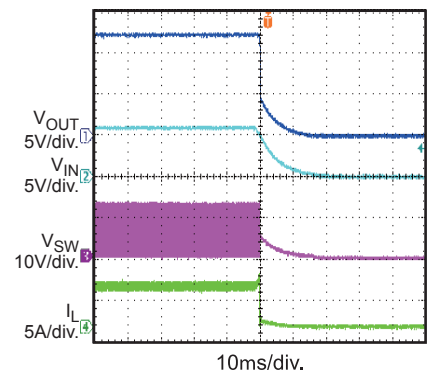

EN Start up

$V_{IN} = 6V, V_{OUT} = 12V/0A$

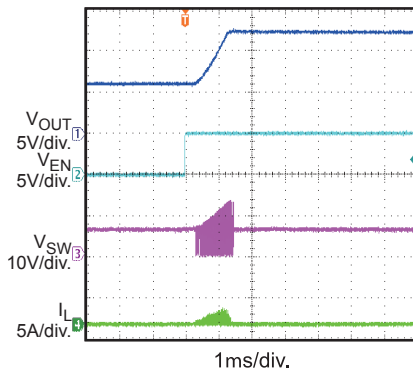

EN Start up

$V_{IN} = 6V, V_{OUT} = 12V/2A$

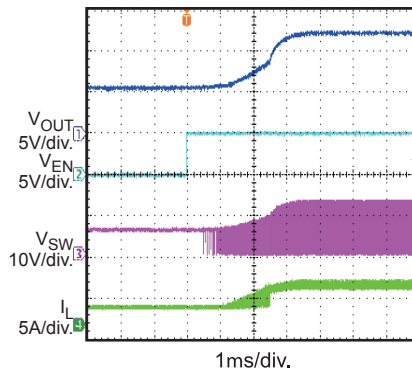

EN Shutdown

$V_{IN} = 6V, V_{OUT} = 12V/0A$

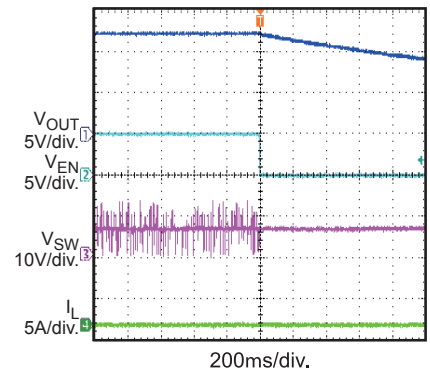

EVB TEST RESULTS *(continued)*

Performance waveforms are tested on the evaluation board.

EN Shutdown

$V_{IN} = 6V$, $V_{OUT} = 12V/2A$

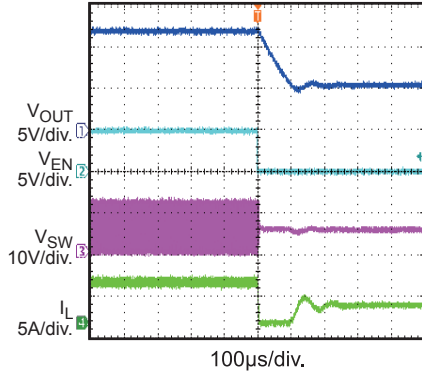

Load Transient

$V_{IN} = 6V$, $V_{OUT} = 12V$,
 $I_{OUT} = 0$ to 1A, $I_{RAMP} = 10mA/\mu s$

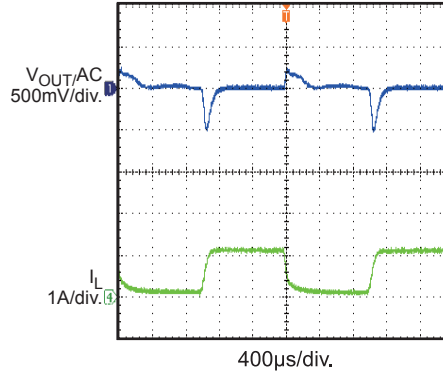

Load Transient

$V_{IN} = 6V$, $V_{OUT} = 12V$,
 $I_{OUT} = 1$ to 2A, $I_{RAMP} = 10mA/\mu s$

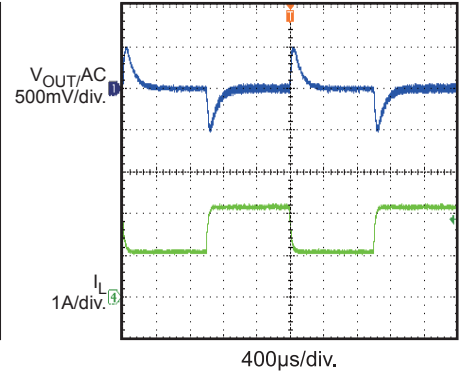

PRINTED CIRCUIT BOARD LAYOUT

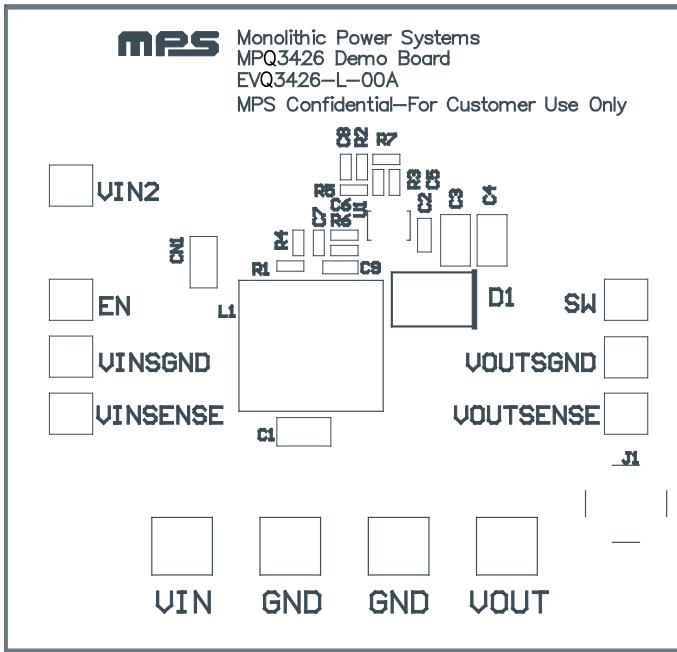

Figure 1—Top Silk Layer

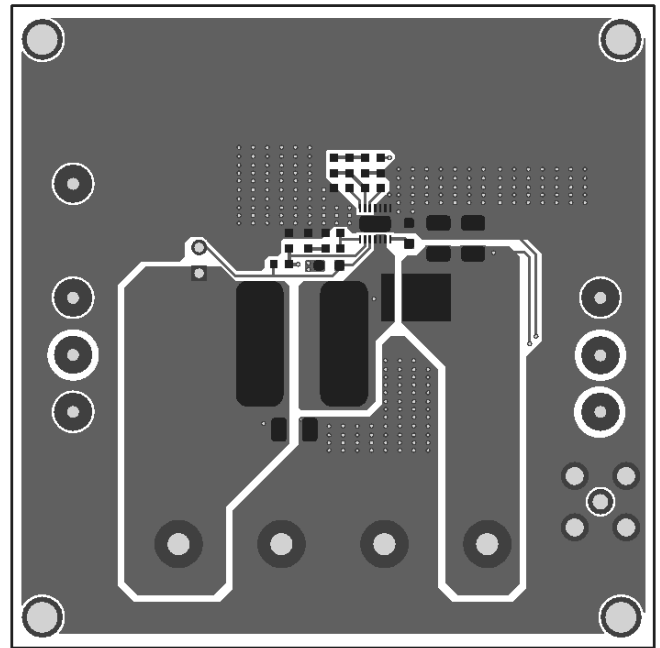

Figure 2—Bottom Layer

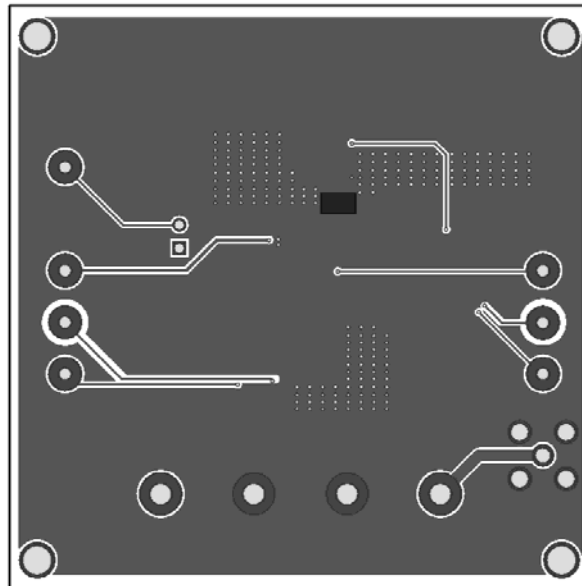

Figure 3—Bottom Layer

QUICK START GUIDE

The output voltage of this board is set to 12V. The frequency is set to 600kHz. The board layout accommodates most commonly used inductors and output capacitors.

1. Preset the power supply to $6V \leq V_{IN} \leq 9V$.
2. Turn the power supply off.
3. Connect the power supply terminals to:
 - a. Positive (+): VIN
 - b. Negative (-): GND
4. Connect the load to:
 - a. Positive (+): VOUT
 - b. Negative (-): GND
5. Make sure the CN1 jumper is installed
6. Turn the power supply on after making the connections.
7. The MPQ3426 is enabled on the evaluation board once VIN is applied.
8. The output voltage VOUT can be changed by varying R2. Calculate the new value using the formula: $R2 = \left(\frac{V_{OUT}}{V_{FB}} - 1\right) \times R3$
Where $V_{FB} = 1.225V$ and $R3=20k\Omega$
9. The frequency can be changed by adjusting R5. The formula is: $F_{SET} = 23 \times (R5^{-0.86})$
Where FSET is in MHz and R5 is in k Ω

NOTICE: The information in this document is subject to change without notice. Users should warrant and guarantee that third party Intellectual Property rights are not infringed upon when integrating MPS products into any application. MPS will not assume any legal responsibility for any said applications.