



The Future of Analog IC Technology®

# EVQ2362DF-00A

## Dual 2A, 23V, 380KHz Step-Down Converter with Frequency Sync Evaluation Board

### DESCRIPTION

The EVQ2362DF-00A is an evaluation board for the MPQ2362, a dual monolithic step-down switch mode converter with built-in internal power MOSFETs.

The MPQ2362 achieves 2A continuous output current for each output over a wide input supply range with excellent load and line regulation. Each channel can be independently synchronized to a frequency up to 1.2MHz.

Current mode operation provides fast transient response and eases loop stabilization.

Fault condition protection includes cycle-by-cycle current limiting and thermal shutdown. In shutdown mode the regulator draws 40µA of supply current.

### FEATURES

- 2A Current for Each Output
- Stable with Low ESR Output Ceramic Capacitors
- Wide 4.75V to 23V Operating Input Range
- Configurable for Single Output with Double the Current
- Fully Assembled and Tested

### APPLICATIONS

- Distributed Power Systems
- I/O and Core supplies
- Set Top Boxes
- Cable Modems

All MPS parts are lead-free and adhere to the RoHS directive. For MPS green status, please visit MPS website under Quality Assurance. "MPS" and "The Future of Analog IC Technology" are Registered Trademarks of Monolithic Power Systems, Inc.

### ELECTRICAL SPECIFICATION

Parameter	Symbol	Value	Units
Input Voltage	V <sub>IN</sub>	4.75 – 23	V
Output Voltage A	V <sub>OUTA</sub>	3.3	V
Output Voltage B	V <sub>OUTB</sub>	2.5	V
Output Current	I <sub>OUT</sub>	2	A

### EVQ2362DF-00A EVALUATION BOARD



(L x W x H) 2.2" x 1.6" x 0.5"  
(5.6cm x 4.0cm x 1.2cm)

Board Number	MPS IC Number
EVQ2362DF-00A	MPQ2362DF

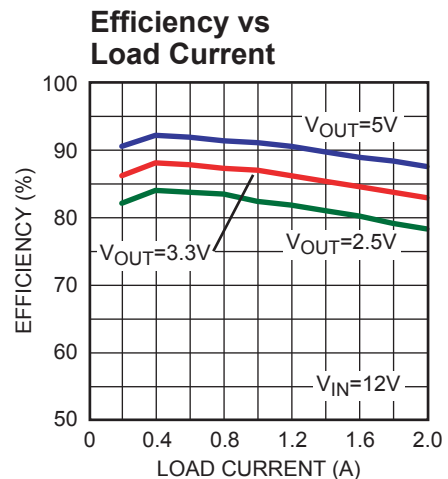

## EVALUATION BOARD SCHEMATIC

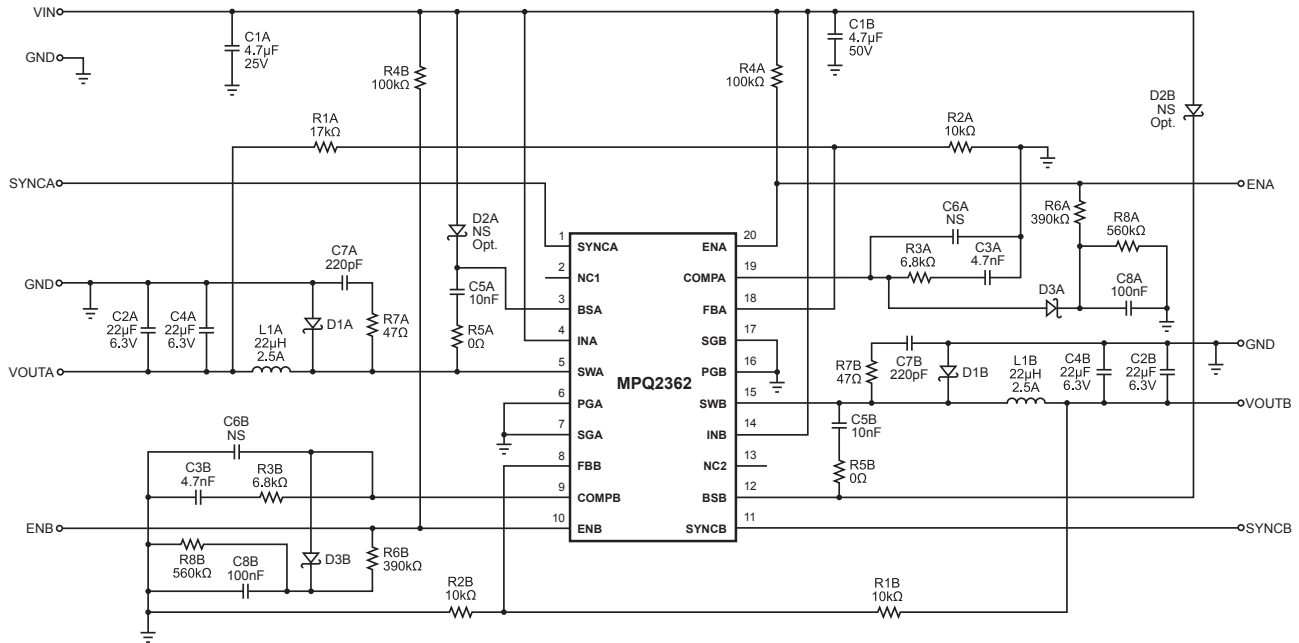

## EVQ2362DF-00A BILL OF MATERIALS

Qty	Ref	Value	Description	Package	Manufacturer P/N
2	C1A, C1B	4.7μF	Ceramic Capacitor, 50V, X7R	1210	TDK: C3225X7R1H475M
4	C2A, C2B, C4A, C4B	22μF	Ceramic Capacitor, 6.3V, X5R	1210	TDK: C3225X5R0J226M
2	C3A, C3B	4.7nF	Ceramic Capacitor, 16V, X7R	0603	TDK
2	C5A, C5B	10nF	Ceramic Capacitor, 16V, X7R	0603	TDK
2	C6A, C6B	NS	Not Stuffed		
2	C7A, C7B	220pF	Ceramic Capacitor, 16V, X7R	0603	TDK
2	C8A, C8B	100nF	Ceramic Capacitor, 16V, X7R	0603	TDK
2	D1A, D1B		Diode Schottky, 40V, 2A	SMA	Diodes Inc.: B240A-13
2	D2A, D2B	NS	Not Stuffed		
2	D3A, D3B	NS	Not Stuffed		
2	L1A, L1B	22μH	Inductor, 3.0A	SMD	TOKO: D140C-220M
1	R1A	17kΩ	Resistor, 1%	0603	Panasonic: ERJ-3EKF173
1	R1B	10kΩ	Resistor, 1%	0603	Panasonic: ERJ-3EKF103
2	R2A, R2B	10kΩ	Resistor, 1%	0603	Panasonic: ERJ-3EKF103

**EVQ2362DF-00A BILL OF MATERIALS** *(continued)*

Qty	Ref	Value	Description	Package	Manufacturer P/N
2	R3A, R3B	6.8k $\Omega$	Resistor	0603	Any
2	R4A, R4B	NS	Not Stuffed		
2	R5A, R5B	0 $\Omega$	Resistor	0603	Any
2	R6A, R6B	NS	Not Stuffed		
2	R7A, R7B	47 $\Omega$	Resistor	0603	Any
2	R8A, R8B	NS	Not Stuffed		
1	U1		Dual Step-Down Converter	TSSOP20	MPS: MPQ2362DF

## EVB TEST RESULTS

Performance waveforms are tested on the evaluation board.

$V_{IN} = 12V$ ,  $C_{1A}=C_{1B}=4.7\mu F$ ,  $C_{2A}=C_{2B}=C_{4A}=C_{4B}=22\mu F$ ,  $L_{1A}=6.8\mu H$ ,  $L_{1B}=4.7\mu H$ , and  $T_A = 25^\circ C$ , unless otherwise noted.

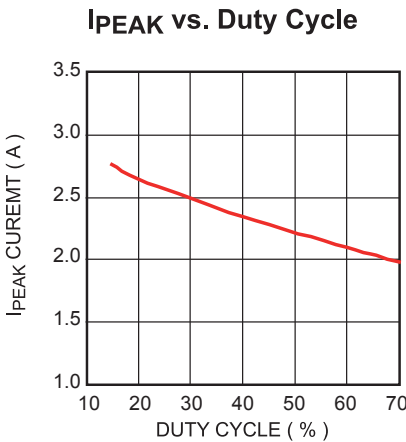
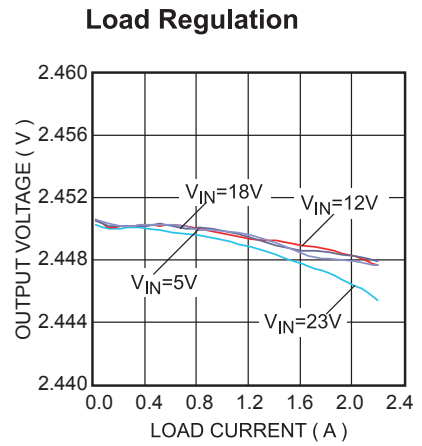
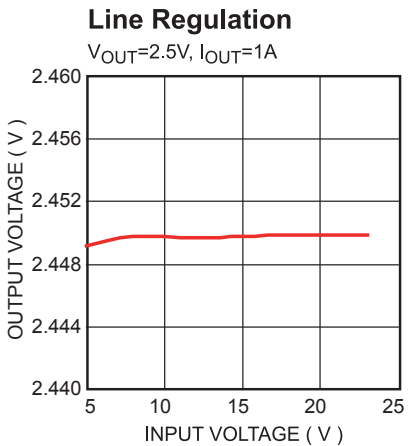
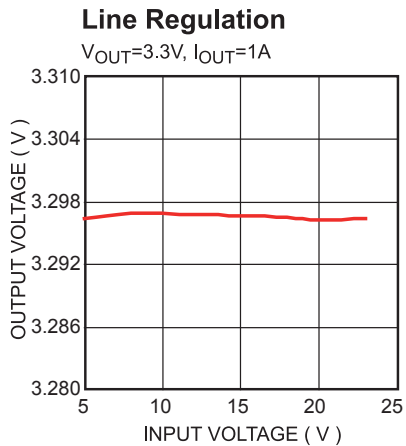
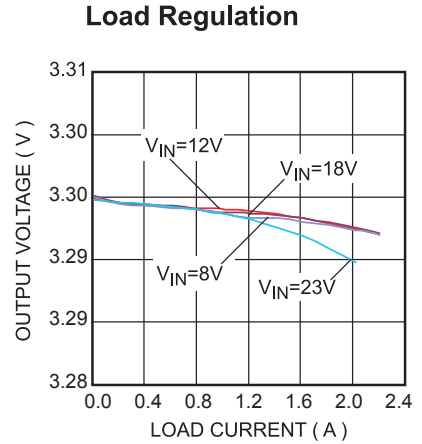
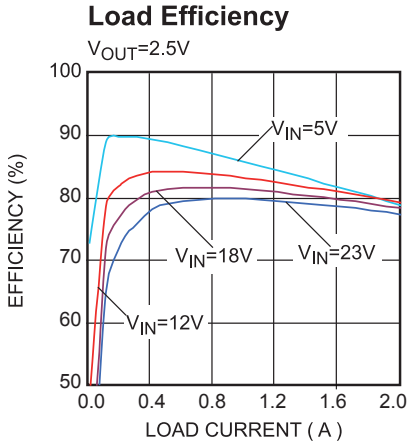
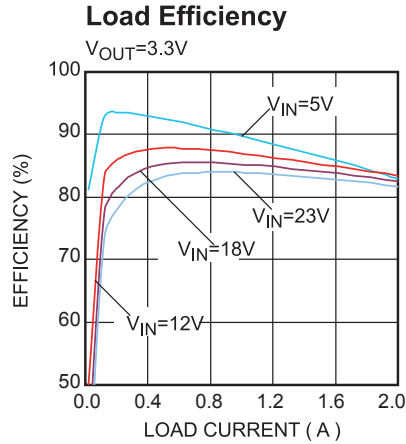

**EVB TEST RESULTS (continued)**

Performance waveforms are tested on the evaluation board.

$V_{IN} = 12V$ ,  $C_{1A}=C_{1B}=4.7\mu F$ ,  $C_{2A}=C_{2B}=C_{4A}=C_{4B}=22\mu F$ ,  $L_{1A}=6.8\mu H$ ,  $L_{1B}=4.7\mu H$ , and  $T_A = 25^\circ C$ , unless otherwise noted.

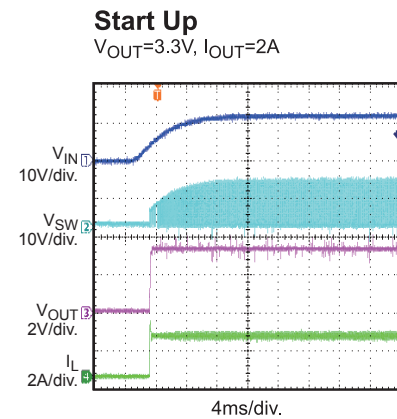
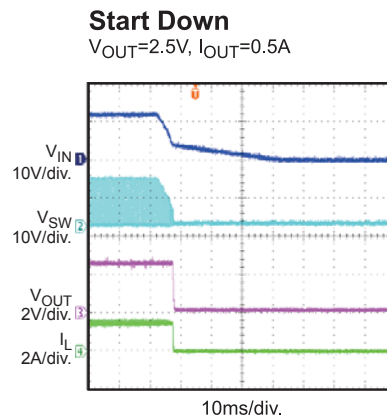
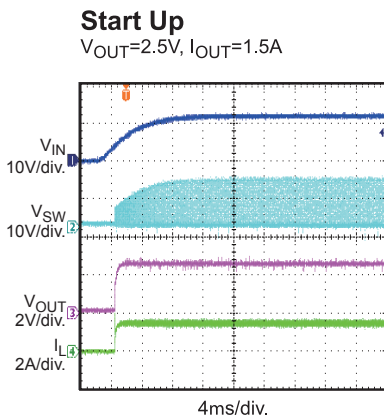
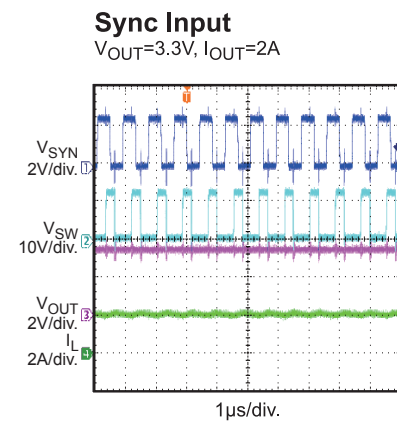
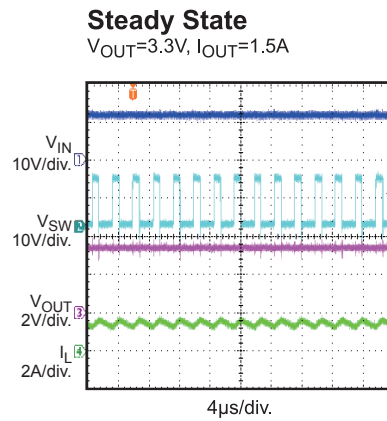
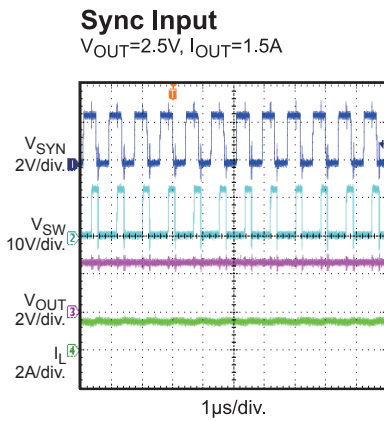
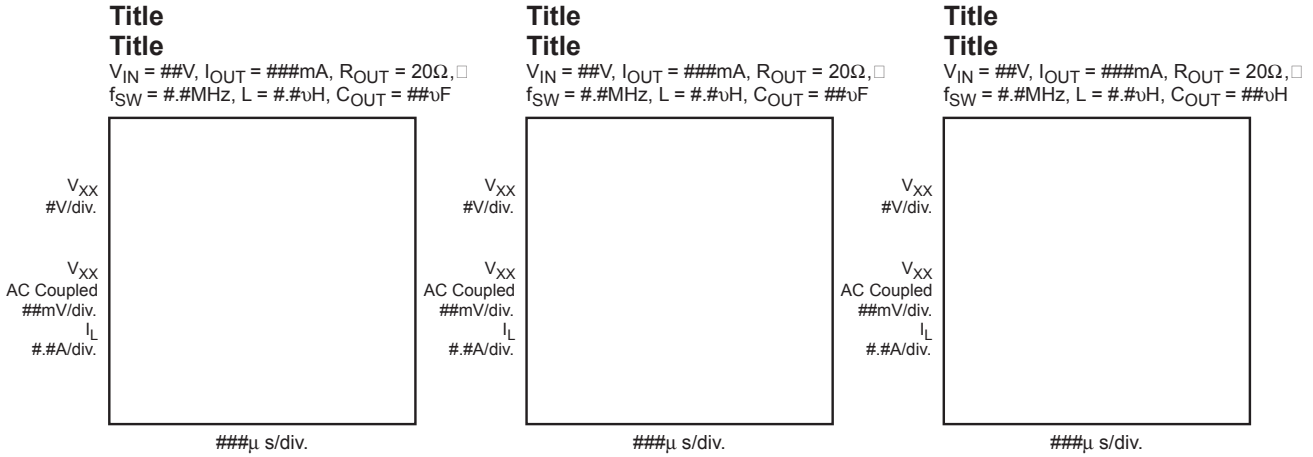

**EVB TEST RESULTS** *(continued)*

Performance waveforms are tested on the evaluation board.

$V_{IN} = 12V$ ,  $C_{1A}=C_{1B}=4.7\mu F$ ,  $C_{2A}=C_{2B}=C_{4A}=C_{4B}=22\mu F$ ,  $L_{1A}=6.8\mu H$ ,  $L_{1B}=4.7\mu H$ , and  $T_A = 25^\circ C$ , unless otherwise noted.

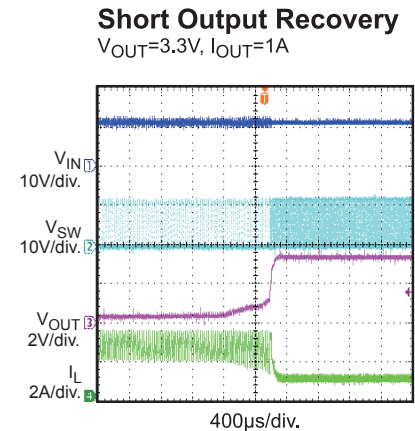
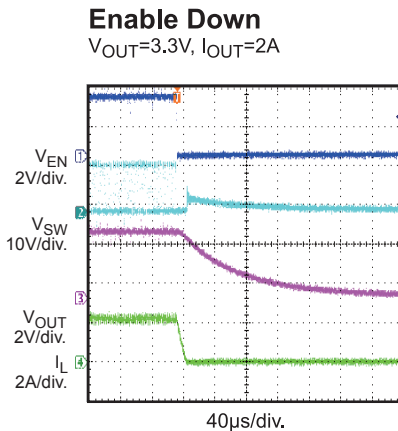
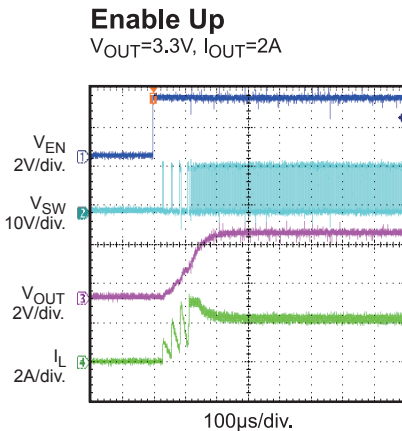
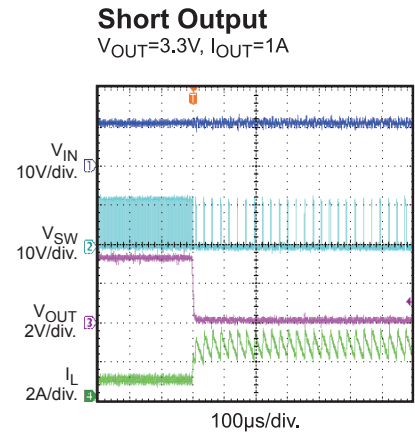
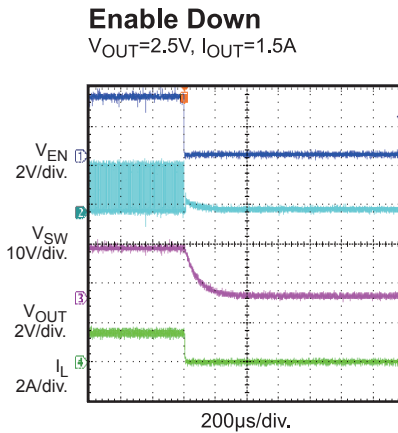
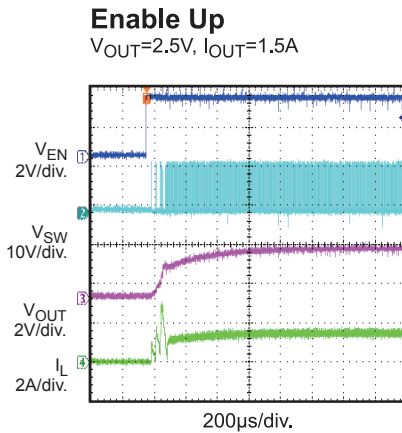
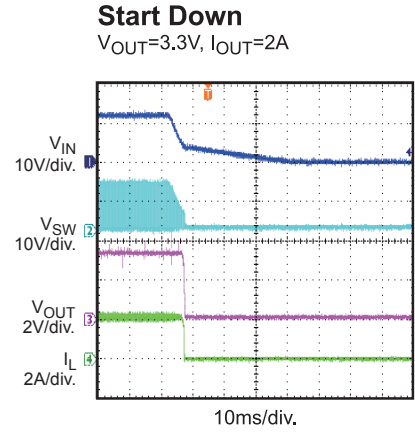
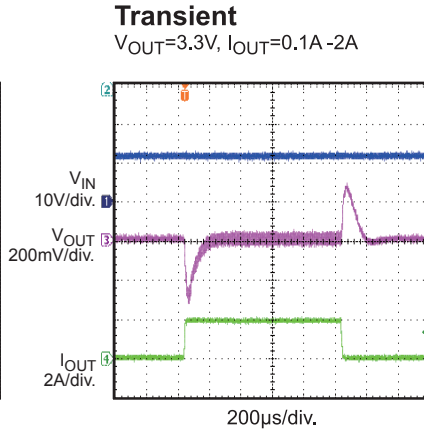
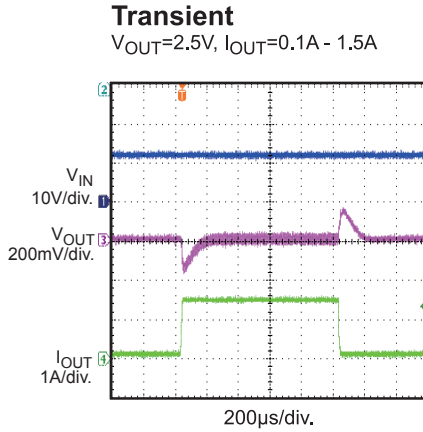

**PRINTED CIRCUIT BOARD LAYOUT**

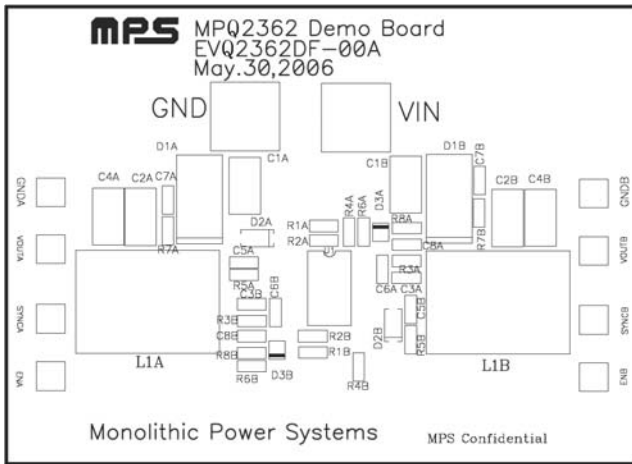

**Figure 1—Top Silk Layer**

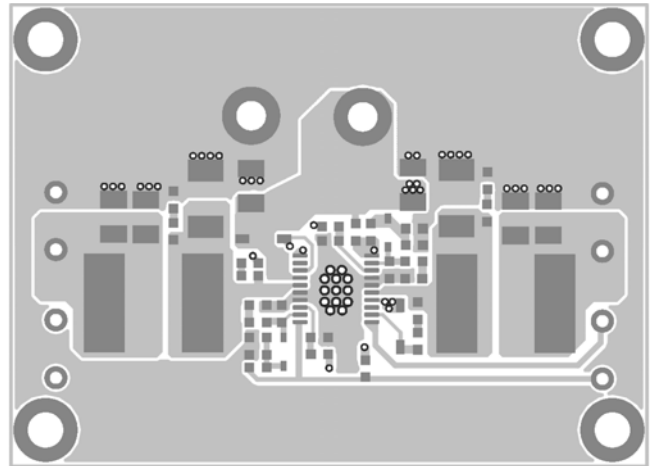

**Figure 2—Top Layer**

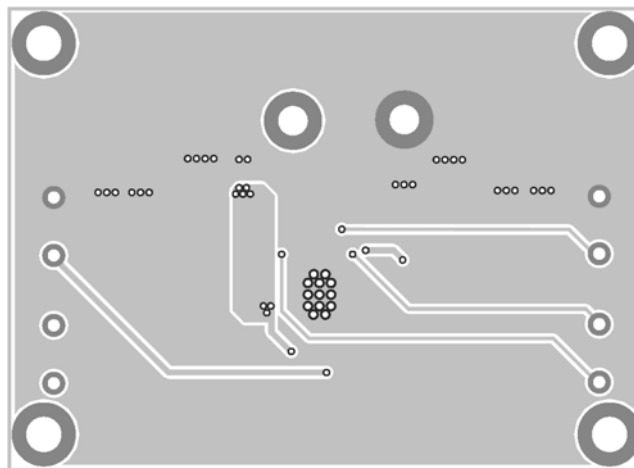

**Figure 3—Bottom Layer**

## QUICK START GUIDE

The output voltages of this board are set to 3.3V (V<sub>OUTA</sub>) and 2.5V (V<sub>OUTB</sub>). The board layout accommodates most commonly used inductors and output capacitors.

1. Attach the positive and negative ends of the first load to the V<sub>OUTA</sub> and GND pins, respectively. If using both outputs, attach the positive and negative ends of the second load to the V<sub>OUTB</sub> and GND pins, respectively.
2. Preset the power supply output to 4.75V to 23V and turn it off.
3. Connect the positive terminal of the power supply output to the VIN pin and the negative terminal of the power supply output to the GND pin.
4. Turn the power supply on. The MPQ2362 will automatically startup.
5. To use the Enable function, apply a digital input to EN pin. Drive EN higher than 2.5V to turn on the regulator and less than 0.7V to turn it off.
6. The Output Voltages V<sub>OUTA</sub> and V<sub>OUTB</sub> can be changed by varying R1A and R1B, respectively.

Calculate the new values by the following formulae:

$$R1A = R2A \times \left( \frac{V_{OA}}{V_{FB}} - 1 \right), \quad R1B = R2B \times \left( \frac{V_{OB}}{V_{FB}} - 1 \right)$$

Where V<sub>FB</sub>=1.222V, R2A = 10kΩ and R2B = 10kΩ.

Example:

For V<sub>OUTA</sub> = 3.3V:

$$R1A = R2A \times \left( \frac{V_O}{V_{FB}} - 1 \right) = 10k\Omega \times \left( \frac{3.3}{1.222} - 1 \right) = 17k\Omega$$

The closest standard 1% value.

7. To use the soft-start function for V<sub>OUTA</sub>, stuff R4A with a 100kΩ resistor, R6A with a 390kΩ resistor, R8A with 560kΩ resistor, C8A with a 100nF capacitor and D3A with a 1N4148. Follow the same procedure for V<sub>OUTB</sub> (ie. Stuff R4B with a 100kΩ resistor, etc).
8. For synchronization to an external clock, please refer to the MPQ2362 datasheet.

**NOTICE:** The information in this document is subject to change without notice. Please contact MPS for current specifications. Users should warrant and guarantee that third party Intellectual Property rights are not infringed upon when integrating MPS products into any application. MPS will not assume any legal responsibility for any said applications.