

DESCRIPTION

The EVQ28261-L-00A is for demonstrating MPS's MPQ28261, a high frequency synchronous rectified step-down switch mode converter with built in internal power MOSFETs. MPQ28261 offers a very compact solution to achieve 3A continuous output current over a wide input supply range with excellent load and line regulation. The MPQ28261 operates at high efficiency over a wide output current load range.

Current mode operation provides fast transient response and eases loop stabilization. The full protection features include OCP and thermal shutdown.

The MPQ28261 requires a minimum number of readily available standard external components and comes in a space saving 3x4mm 14-pin QFN package.

ELECTRICAL SPECIFICATION

Parameter	Symbol	Value	Units
Input Voltage	V_{IN}	7 – 21	V
Output Voltage	V_{OUT}	1.2	V
Output Current	I_{OUT}	3	A

FEATURES

- Wide 7V to 21V Operating Input Range
- 0.6V Internal Reference with 2% Accuracy
- 3A Output Current
- Low $R_{ds(ON)}$ Internal Power MOSFETs
- Fixed 500kHz Switching Frequency
- External Soft Start
- OCP and Thermal Shutdown
- Available in 14-pin QFN3x4 Package

APPLICATIONS

- DSL Modems
- Cable Modems
- Set Top Boxes

"For MPS green status, please visit MPS website under Quality Assurance MPS" and "The Future of Analog IC Technology", are Registered Trademarks of Monolithic Power Systems, Inc.

ADAM (Analog Digital Adaptive Modulation), AAM (...) are Trademarks of Monolithic Power Systems, Inc.

The EVQ28261-L-00A is covered by US Patents,

EVQ28261-L-00A EVALUATION BOARD



Board Number	MPS IC Number
EVQ28261-L-00A	MPQ28261DL

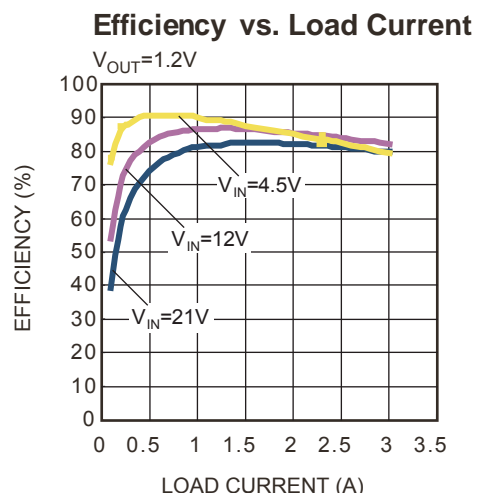

EVALUATION BOARD SCHEMATIC

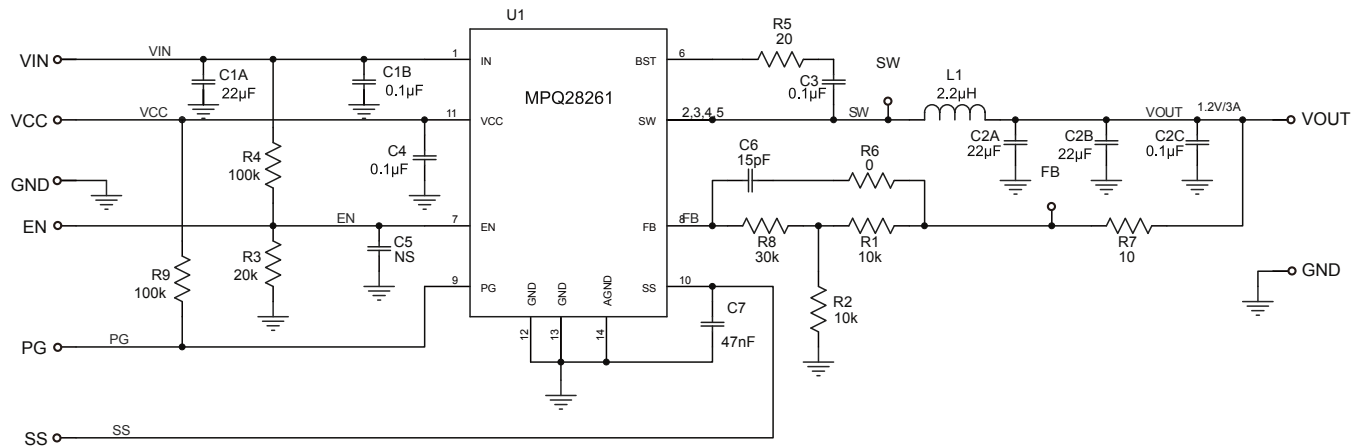

EVQ28261-L-00A BILL OF MATERIALS

Qty	Ref	Value	Description	Package	Manufacturer	Part Number
1	C1A	22µF	Ceramic Cap., 25V, X5R	1210	Murata	GRM32ER61E226KE15L
1	C1B	0.1µF	Ceramic Cap., 25V, X7R	0805	HHEC	C0805X104K025T
2	C2A,C2B	22µF	Ceramic Cap., 6.3V, X5R	1210	Murata	GRM32DR60J226KA01L
1	C2C	0.1µF	Ceramic Cap., 16V, X7R	0805	Murata	GRM219R71C104KA01D
2	C3,C4	0.1µF	Ceramic Cap., 25V, X7R	0603	Yageo	CC0603KRX7R8BB104
0	C5	NS		0603		
1	C6	15pF	Ceramic Cap., 50V,C0G	0603	TDK	C1608C0G1H150J
1	C7	47nF	Ceramic Cap., 50V,X7R	0603	Murata	GRM188R71H473KA61D
1	R1	10k	Film Res., 1%	0603	Yageo	RC0603FR-0710KL
1	R2	10k	Film Res., 1%	0603	Yageo	RC0603FR-0710KL
1	R3	20 kΩ	Film Res., 5%	0603	Any	
2	R4,R9	100 kΩ	Film Res., 5%	0603	Any	
1	R8	30 kΩ	Film Res., 5%	0603	Any	
1	R5	20Ω	Film Res., 5%	0603	Any	
1	R6	0Ω	Film Res., 5%	0603	Any	
1	R7	10Ω	Film Res., 5%	0603	Any	
1	L1	1.8µH	7.6mΩ, 10.4A	SMD	TOKO	D104C-919AS-1R8N
		2.2µH	14mΩ, 13A	SMD	Würth	744311220
1	U1		Step-Down Converter	QFN14	MPS	MPQ28261DL

EVB TEST RESULTS

Performance waveforms are tested on the evaluation board.

$V_{IN} = 12V$, $V_{OUT} = 1.2V$, $L = 2.2\mu H$, $T_A = 25^\circ C$, unless otherwise noted.

Short Entry

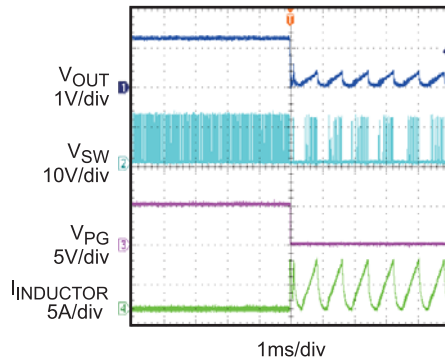

Short Recovery

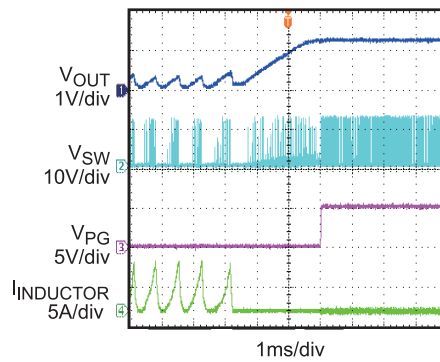

Power Up without Load

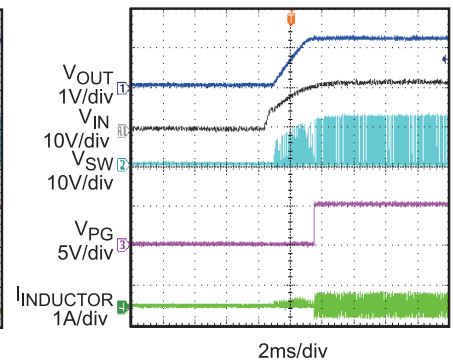

Power Up with 3A Load

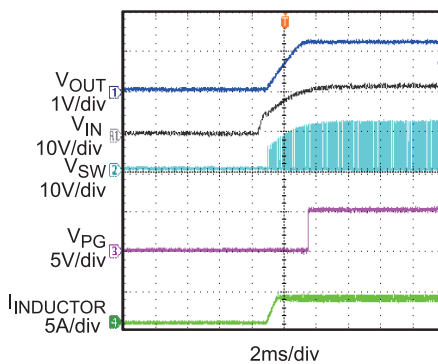

Power Off with 3A Load

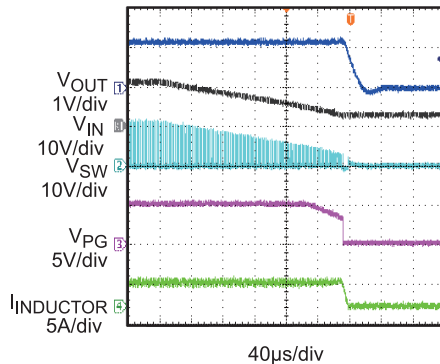

Enable Startup without Load

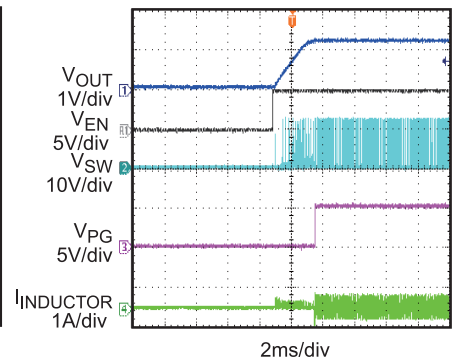

Enable Startup with 3A Load

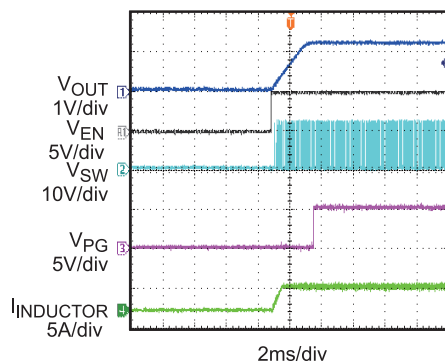

Enable Shutdown with 3A Load

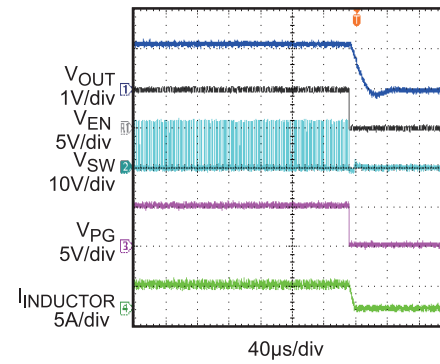

Input Ripple Voltage

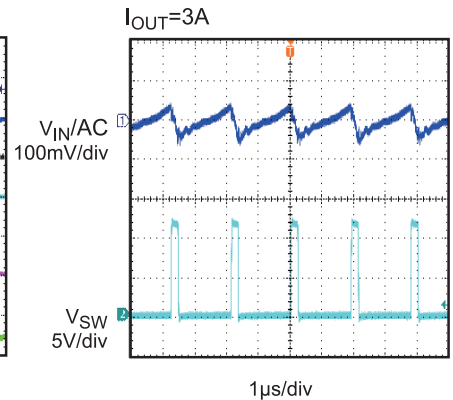

EVB TEST RESULTS (continued)

Performance waveforms are tested on the evaluation board.

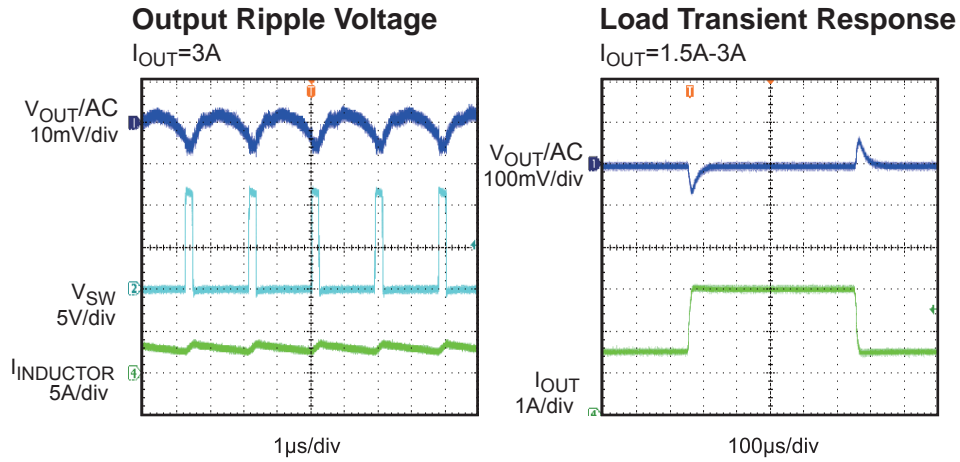
 $V_{IN} = 12V$, $V_{OUT} = 1.2V$, $L = 2.2\mu H$, $T_A = 25^\circ C$, unless otherwise noted.

PRINTED CIRCUIT BOARD LAYOUT

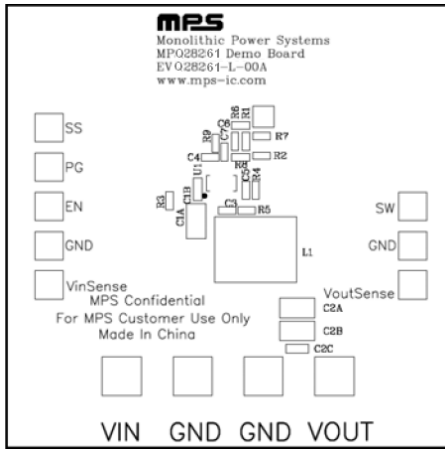

Figure 1—Top Silk Layer

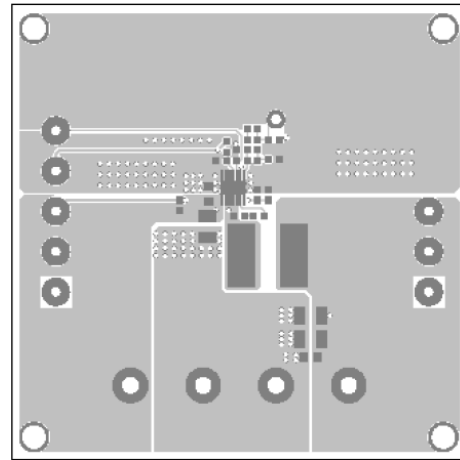

Figure 2—Top Layer

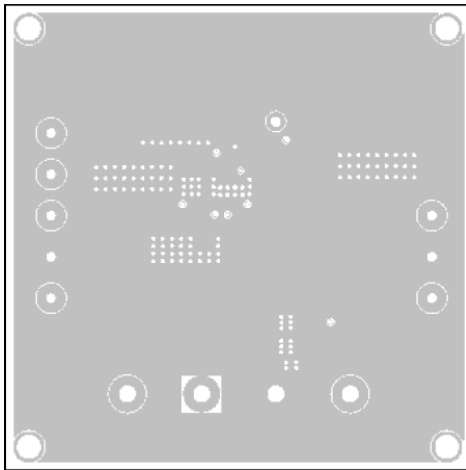

Figure 3—Inner 1 Layer

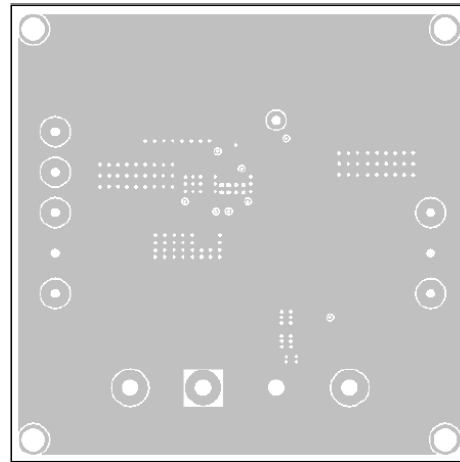

Figure 4— Inner 2 Layer

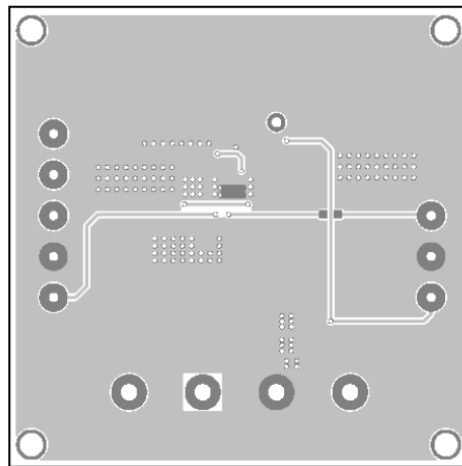

Figure 5—Bottom Layer

QUICK START GUIDE

1. Connect the positive and negative terminals of the load to the VOUT and GND pins, respectively.
2. Preset the power supply output between 7V and 21V, and then turn off the power supply.
3. Connect the positive and negative terminals of the power supply output to the VIN and GND pins, respectively.
4. Turn the power supply on. The board will automatically start up.
5. To use the Enable function, apply a digital input to the EN pin. Drive EN higher than 1.6V to turn on the regulator or less than 0.4V to turn it off.

NOTICE: The information in this document is subject to change without notice. Please contact MPS for current specifications. Users should warrant and guarantee that third party Intellectual Property rights are not infringed upon when integrating MPS products into any application. MPS will not assume any legal responsibility for any said applications.